

**BY ORDER OF THE  
SECRETARY OF THE AIR FORCE**

**AIR FORCE MANUAL 11-202 Volume 3**

**10 JUNE 2020**



**AIR FORCE MATERIEL COMMAND  
Supplement**

**14 JUNE 2021**

**Flying Operations**

**FLIGHT OPERATIONS**

**COMPLIANCE WITH THIS PUBLICATION IS MANDATORY**

---

**ACCESSIBILITY:** Publications and forms are available on the e-Publishing website at <http://www.e-publishing.af.mil/> for downloading or ordering.

**RELEASABILITY:** There are no releasability restrictions on this publication.

---

OPR: AFFSA/XOF

Certified by: AF/A30  
(Mr. Trent Dudley)

Supersedes: AFMAN11-202V3, 8 May 2020;  
AFMAN11-217, 10 June 2019;  
AFI11-202V3, 10 August 2016

Pages: 311

**(AFMC)**

OPR: USAF/ HQ AFMC/A3V

Certified by: HQ AFMC/A3V  
(Col H. Warren Rohlf)

Supersedes: AFI11-202V3\_AFMCSUP,  
24 November 2015

Pages: 15

---

This manual implements Air Force Policy Directive (AFPD) 11-2, *Aircrew Operations*, by prescribing general flight rules that govern the operation of United States Air Force (USAF) aircraft. This manual applies to individuals at all levels who operate Air Force (AF) aircraft (manned and unmanned), to include civilian aircrews, and uniformed members of the Regular Air Force, the Air Force Reserve and the Air National Guard (ANG), and pilots assigned to other services or from other nations (in accordance with applicable Memorandums of Agreement). Individual aircraft flight manuals should provide detailed instructions for specific aircraft instrumentation or characteristics. Ensure all records created as a result of processes prescribed in this publication are maintained in accordance with Air Force Manual (AFMAN) 33-363, *Management of Records*, and disposed of in accordance with the Air Force Records Disposition Schedule located in the Air Force Records Information Management System. Refer recommended changes and questions about this publication to the office of primary responsibility (OPR) using

the AF Form 847, *Recommendation for Change of Publication*; route AF Forms 847 from the field through the appropriate functional chain of command. This publication may be supplemented, but all supplements must be routed to AFFSA/XOF for coordination prior to certification and approval. Mission Design Series (MDS)-specific 11-series Volume 3 AFMANs (e.g., AFMAN 11-2C-17, Volume 3) may contain specific operational guidance unique to individual aircraft and crew positions. MDS-specific, Volume 3 manuals will not be less restrictive than this manual. The authorities to waive wing or unit level requirements in this publication are identified with a Tier (“T-0, T-1, T-2, or T-3”) number following the compliance statement. See Air Force Instruction (AFI) 33-360, *Publications and Forms Management*, for a description of the authorities associated with the Tier numbers. Submit requests for waivers through the chain of command in accordance with [paragraph 1.7](#) of this AFMAN. The use of the name or mark of any specific manufacturer, commercial product, commodity, or service in this publication does not imply endorsement by the Air Force.

(AFMC) AFMAN11-202V3, *Flight Operations*, is supplemented as follows: This supplement describes AFMC’s general flight rules and procedures for use in conjunction with the basic AFMAN. It applies to all AFMC units and personnel conducting flying operations. This supplement does not apply to Air National Guard (ANG) and the Air Force Reserve Command (AFRC) units and members except those under AFMC OPCON. It also applies to DCMA units under AFMC OPCON. Ensure that all records created as a result of processes prescribed in this publication are maintained in accordance with (IAW) AFI 33-322, *Records Management and Information Governance Program*, and disposed of IAW Air Force Records Information Management System Records Disposition Schedule. Refer recommended changes and questions about this publication to the Office of Primary Responsibility (OPR) using AF Form 847, *Recommendation for Change of Publication*; route AF Forms 847 from the field through the appropriate functional chain of command to AFMC/A3V. The authorities to waive wing, and unit level requirements in this publication are identified with a tier number (“T-0, T-1, T-2, T-3”) following the compliance statement. See Department of the Air Force Instruction (DAFI) 33-360, *Publications and Forms Management*, for a description of the authorities associated with the Tier numbers. Submit requests for waivers through the chain of command to the appropriate Tier waiver approval authority, or alternately, to the Publication OPR for non-tiered compliance items. [Attachment 1](#) contains a glossary of references and is not mandatory for compliance. This publication may not be supplemented or further implemented/extended.

### ***SUMMARY OF CHANGES***

This document has been substantially revised and must be completely reviewed. Major changes include: (1) consolidating AFMAN 11-217 and AFI 11-202V3; (2) expanding allowable departure methods; and (3) reorganizing chapter order for better information flow; and (4) improves AFMAN 11-202V3, 8 May 2020 figure resolution and quality without textual or content changes.

(AFMC) This document has been substantially revised and must be completely reviewed. Major changes include: Numerous paragraphs renumbered and chapters reorganized to synchronize with new AFMAN 11-202V3; Tiering, waiver authority and approval authority clarified throughout; Deleted duplicate guidance found in other instructions; Updated pilot requirements and restrictions table.

|  |           |
|--|-----------|
| <b>Chapter 1— Overview</b>                             | <b>23</b> |
| 1.1. General. ....                                     | 23        |
| 1.2. Scope.....  | 23        |
| 1.3. References to Source Material. ....               | 23        |
| 1.4. Flight Operations in International Airspace. .... | 25        |
| 1.5. Flight Operation in Foreign Airspace. ....        | 26        |
| 1.6. Flight Operations within the NAS. ....            | 26        |
| 1.7. Waivers. ....                                     | 26        |
| 1.8. Violations. ....                                  | 27        |
| 1.9. Deviations. ....                                  | 27        |
| 1.10. Aviation Safety Reporting. ....                  | 27        |
| 1.11. Airworthiness. ....                              | 27        |
| <b>Chapter 2— ROLES AND RESPONSIBILITIES</b>           | <b>28</b> |
| 2.1. Air Force Flight Standards Agency (AFFSA). ....   | 28        |
| 2.2. Major Command (MAJCOM). ....                      | 28        |
| 2.2. Major Command (MAJCOM). ....                      | 28        |
| 2.3. Pilot in Command (PIC). ....                      | 32        |
| 2.4. Aircrew. ....                                     | 33        |
| <b>Chapter 3— GENERAL FLIGHT RULES</b>                 | <b>34</b> |
| 3.1. Crew Rest. ....                                   | 34        |
| 3.2. Flight Duty Period (FDP). ....                    | 34        |
| Table 3.1. Maximum FDP. ....                           | 35        |
| 3.3. Deadhead Time. ....                               | 35        |
| 3.4. Maximum Flying Time. ....                         | 36        |
| 3.5. Controlled Cockpit Rest. ....                     | 36        |
| 3.6. Aircrew Flight Equipment. ....                    | 36        |
| 3.7. Aircrew Medical Standards. ....                   | 36        |
| 3.8. Nonrated Flyers. ....                             | 36        |

|       |       |  |    |
|-------|-------|--|----|
|       | 3.9.  | Flight Demonstrations and Aerial Events. ....                                    | 36 |
|       | 3.10. | Transporting Passengers Under the Influence. ....                                | 36 |
|       | 3.11. | Tobacco Use. ....  | 37 |
|       | 3.12. | Transport of Drugs. ....   | 37 |
|       | 3.13. | Hazardous Cargo. ....  | 37 |
|       | 3.14. | Flight Displays. ....  | 37 |
|       | 3.14. | Flight Displays. ....  | 37 |
|       | 3.15. | Authorized Resources for Flight and Mission-Related Duties. ....                 | 37 |
|       | 3.15. | Authorized Resources for Flight and Mission-Related Duties. ....                 | 37 |
|       | 3.16. | Portable Electronic Devices (PEDs). ....   | 37 |
|       | 3.16. | Portable Electronic Devices (PEDs). ....   | 37 |
|       | 3.17. | Electronic Flight Bags (EFBs) [FAA AC 120-76].....                               | 38 |
|       | 3.18. | Aircraft Movement on the Ground. ....  | 38 |
|       | 3.19. | Crew at Stations. ....   | 38 |
|       | 3.20. | Inflight Reporting. ....   | 39 |
|       | 3.21. | Oxygen and Pressurization Requirements (N/A for UAS). ....                       | 39 |
| Table | 3.2.  | Oxygen Requirements for Pressurized Aircraft According to Aircraft Altitude. ... | 40 |
| Table | 3.3.  | Cabin Altitude Time Limits (Decompression Sickness Prevention). ....             | 41 |
|       | 3.22. | Aircraft Lighting. ....  | 41 |
|       | 3.23. | Airfield Lighting. ....  | 42 |
|       | 3.24. | Right-of-Way. ....   | 42 |
|       | 3.25. | See and Avoid. ....  | 43 |
|       | 3.26. | Adherence to ATC Clearances and Instructions. ....                               | 43 |
|       | 3.27. | Descent Gradients. ....  | 43 |
|       | 3.28. | Airspeed Adjustments.....  | 43 |
|       | 3.29. | Operating Near other Aircraft. ....  | 44 |
|       | 3.30. | Dropping Parachutists, Stores, or Other Objects. ....                            | 44 |
|       | 3.31. | Fuel Jettison. ....  | 44 |
|       | 3.32. | Radio, Laser, and Other Electromagnetic Emitter Restrictions. ....               | 44 |



|                   |  |           |
|-------------------|--|-----------|
| 3.33.             | Communication Equipment. ....  | 44        |
| 3.34.             | Navigation Equipment. ....   | 44        |
| 3.35.             | Transponder Operations. ....   | 44        |
| Figure 3.1.       | Transponder Emission Summary. ....                                       | 45        |
| 3.36.             | Automatic Dependent Surveillance – Broadcast (ADS-B) Operations. ....    | 45        |
| 3.37.             | TCAS Operations. ....  | 46        |
| 3.38.             | Communication, Navigation, and Surveillance Equipment Malfunctions. .... | 47        |
| 3.39.             | Terrain Awareness and Warning Systems (TAWS). ....                       | 47        |
| 3.39.             | Terrain Awareness and Warning Systems (TAWS). ....                       | 47        |
| 3.40.             | Carry-On Equipment. ....   | 47        |
| 3.41.             | Formation Flights (Including Air Refueling). ....                        | 47        |
| 3.41.             | Formation Flights (Including Air Refueling). ....                        | 47        |
| 3.42.             | Aerobatics. ....   | 48        |
| 3.43.             | Air Combat Tactics. ....   | 48        |
| 3.44.             | Temporary Flight Restriction (TFR) Airspace. ....                        | 48        |
| 3.45.             | Operating at Non-towered Airports. ....                                  | 49        |
| 3.46.             | Simulated Instrument Flight. ....  | 49        |
| 3.47.             | Simulated Emergency Flight. ....   | 49        |
| 3.48.             | Vertical-Lift Operations. ....   | 50        |
| 3.48.             | Vertical-Lift Operations. ....   | 50        |
| <b>Chapter 4—</b> | <b>MISSION PLANNING</b>  | <b>51</b> |
| 4.1.              | General. ....  | 51        |
| 4.2.              | Flight Authorization. ....   | 51        |
| 4.3.              | Pilot in Command. ....   | 52        |
| 4.4.              | Approval Authority. ....   | 52        |
| 4.5.              | Flight Plans. ....   | 52        |
| 4.6.              | Mission Planning Requirements. ....                                      | 53        |
| 4.7.              | Civil, Military, and Joint-Use Airports. ....                            | 54        |
| 4.8.              | UAS Airfields and Operations. ....                                       | 55        |

|        |       |   |    |
|--------|-------|---|----|
|        | 4.9.  | Aviation Into-Plane Reimbursement Card (AIR Card®) Responsibilities. .... | 55 |
|        | 4.10. | Weather Information. ....   | 55 |
| Table  | 4.1.  | RVR to Prevailing Visibility Conversion. ....                             | 56 |
|        | 4.11. | Notices To Airmen (NOTAMs). ....  | 56 |
|        | 4.12. | Critical Distance Measuring Equipment (DME) NOTAMs. ....                  | 57 |
|        | 4.13. | Performance-Based Navigation (PBN). ....                                  | 57 |
|        | 4.14. | Aeronautical Information and Publications. ....                           | 59 |
|        | 4.15. | IFR Flight. ....  | 60 |
|        | 4.16. | IFR Alternate. ....   | 60 |
|        | 4.17. | PBN Alternate Airfield Considerations. ....                               | 62 |
|        | 4.18. | IFR Alternate Minimums. ....  | 63 |
| Figure | 4.1.  | IFR Alternate Minimums Symbol. ....                                       | 63 |
| Figure | 4.2.  | Alternate Not Authorized Symbol. ....                                     | 63 |
|        | 4.19. | VFR Flight. ....  | 63 |
|        | 4.20. | Fuel Requirements. ....   | 64 |
|        | 4.21. | Preflight Briefings.....  | 64 |
|        | 4.22. | Aircraft Category. ....   | 65 |
| Table  | 4.2.  | Aircraft Category. ....   | 65 |
|        | 4.23. | Automation Management. ....   | 66 |
|        | 4.24. | Transitioning Airspace Classes. ....                                      | 66 |
|        | 4.25. | VFR Flight in Controlled Airspace. ....                                   | 66 |
|        | 4.26. | IFR Flight in Uncontrolled Airspace. ....                                 | 66 |
|        | 4.27. | Airspace and Airspace Classification. ....                                | 66 |
| Figure | 4.3.  | NAS Airspace Classification. ....   | 67 |
| Figure | 4.4.  | ICAO Airspace Classification.....   | 68 |
|        | 4.28. | Reduced Vertical Separation Minimum (RVSM). ....                          | 70 |
|        | 4.28. | Reduced Vertical Separation Minimum (RVSM). ....                          | 70 |
|        | 4.29. | Procedures for Accommodation of Non-RVSM Aircraft in RVSM Airspace. ....  | 70 |
|        | 4.30. | Level Off Operating Practices. ....                                       | 70 |

|        |       |   |    |
|--------|-------|---|----|
|        | 4.31. | Air Traffic Services (ATS). .....   | 70 |
|        | 4.32. | Emergency Frequencies. ....   | 71 |
|        | 4.33. | Flight Service Station (FSS). ....  | 71 |
|        | 4.34. | Local Airport Advisory. ....  | 71 |
|        | 4.35. | Remote Airport Information Service. ....                                      | 71 |
|        | 4.36. | VFR Radar Assistance. ....  | 72 |
|        | 4.37. | VFR Flight Following. ....  | 72 |
|        | 4.38. | VFR Cruising Altitudes and Flight Levels. ....                                | 72 |
| Table  | 4.3.  | VFR Cruising Altitudes and Flight Levels. ....                                | 72 |
|        | 4.39. | Composite Flight Plan (IFR/VFR Flights). ....                                 | 72 |
|        | 4.40. | [ICAO] Transitioning IFR to VFR. ....   | 73 |
|        | 4.41. | VFR Helicopter Operations. ....   | 73 |
|        | 4.42. | VFR-on-top. ....  | 73 |
|        | 4.43. | Special VFR. ....   | 73 |
|        | 4.44. | Defense VFR (DVFR). ....  | 73 |
|        | 4.45. | Inadvertent Flight into IMC While Operating Under VFR. ....                   | 74 |
|        | 4.46. | [NAS Only] Declared Distances. ....   | 74 |
| Figure | 4.5.  | [NAS Only] Declared Distance Symbol. ....                                     | 74 |
| Figure | 4.6.  | [NAS Only] Declared Distances. ....   | 75 |
| Figure | 4.7.  | Effects of a Geographical Constraint on Runway Declared Distances. ....       | 76 |
|        | 4.47. | Altimeter Settings. ....  | 76 |
| Figure | 4.8.  | Types of Altimeter Settings. ....   | 77 |
|        | 4.48. | Altimeter Use in Flight. ....   | 77 |
|        | 4.49. | Flight in Extreme Barometric Pressures. ....                                  | 78 |
|        | 4.50. | Flight in Colder Than International Standard Atmosphere (ISA) Temperatures. . | 78 |
| Figure | 4.9.  | NAS Designated Mountainous Areas. ....  | 79 |
|        | 4.51. | Cold Weather Altimeter Corrections. ....                                      | 79 |
| Table  | 4.4.  | Cold Weather Altitude Corrections. ....                                       | 80 |
| Table  | 4.5.  | Pilot Requirements and Restrictions. ....                                     | 80 |

|                             |       |  |           |
|-----------------------------|-------|--|-----------|
|                             | 4.52. | Calculating Cold Temperature Corrections. ....                   | 82        |
| Figure                      | 4.10. | Temperature Correction Example, KNID, TACAN RWY 32.....          | 83        |
| Figure                      | 4.11. | Example Temperature Correction.....                              | 84        |
| Figure                      | 4.12. | KATW ILS or LOC RWY 3.....                                       | 85        |
| Figure                      | 4.13. | Cold Temperature Corrections – Remote Altimeter Setting.....     | 86        |
|                             | 4.53. | FAA Cold Temperature Restricted Airports.....                    | 86        |
| Figure                      | 4.14. | Snowflake Icon. ....   | 86        |
| <b>Chapter 5— DEPARTURE</b> |       |  | <b>87</b> |
|                             | 5.1.  | General. ....  | 87        |
|                             | 5.2.  | Weather. ....  | 87        |
|                             | 5.2.  | Weather. ....  | 87        |
|                             | 5.3.  | Hazardous Weather. ....  | 87        |
|                             | 5.4.  | Freezing and Frozen Precipitation or Weather. ....               | 87        |
|                             | 5.5.  | Aircraft Ground Deicing. ....                                    | 87        |
|                             | 5.6.  | VFR Communication.....   | 87        |
|                             | 5.7.  | VFR Departure. ....  | 87        |
|                             | 5.7.  | VFR Departure. ....  | 88        |
|                             | 5.8.  | IFR Climb Performance. ....                                      | 88        |
|                             | 5.8.  | IFR Climb Performance. ....                                      | 88        |
|                             | 5.9.  | IFR Departure Methods. ....                                      | 88        |
|                             | 5.10. | IFR Departure Climb Gradients. ....                              | 89        |
| Table                       | 5.1.  | IFR DER Crossing Restrictions (Unless Published Otherwise). .... | 89        |
|                             | 5.11. | ICAO Departure Speeds. ....                                      | 90        |
| Table                       | 5.2.  | ICAO Maximum Allowable Departure Speeds. ....                    | 90        |
|                             | 5.12. | IFR Departure Procedures. ....                                   | 90        |
| Figure                      | 5.1.  | “Trouble T” Symbol. ....   | 90        |
|                             | 5.13. | Takeoff Obstacle Notes. ....                                     | 91        |
|                             | 5.14. | Low Close-in Obstacles. ....                                     | 91        |
| Figure                      | 5.2.  | Low Close-in Obstacles.....                                      | 91        |

|              |  |     |
|--------------|--|-----|
| 5.15.        | Diverse Departure. ....                                | 91  |
| Figure 5.3.  | Diverse Departure Obstacle Assessment. ....            | 92  |
| Figure 5.4.  | Diverse Departure Not Authorized (Runway 36R).....     | 92  |
| Figure 5.5.  | Sector Diverse Departure.....                          | 93  |
| 5.16.        | ICAO Omnidirectional Departure. ....                   | 93  |
| Figure 5.6.  | Omnidirectional Departure. ....                        | 94  |
| 5.17.        | Non-standard IFR Takeoff Minimums. ....                | 94  |
| Figure 5.7.  | IFR Takeoff Minimums – Non-standard. ....              | 95  |
| Figure 5.8.  | IFR Takeoff Minimums – Non –standard.....              | 95  |
| Figure 5.9.  | IFR Takeoff Minimums – “Or Standard”. ....             | 95  |
| Figure 5.10. | IFR Takeoff Minimums – Specific Aircraft Category..... | 96  |
| 5.18.        | Specific Routing. ....                                 | 96  |
| Figure 5.11. | Specific Routing. ....                                 | 96  |
| 5.19.        | Visual Climb Over Airport (VCOA). ....                 | 96  |
| Table 5.3.   | VCOA Radius Value. ....                                | 97  |
| Figure 5.12. | Visual Climb Area. ....                                | 97  |
| Figure 5.13. | VCOA Format.....                                       | 98  |
| Figure 5.14. | Legacy VCOA Format.....                                | 98  |
| Figure 5.15. | Non-Conforming VCOA Format.....                        | 99  |
| 5.20.        | Reduced Takeoff Runway Length Procedure (RTRL). ....   | 99  |
| Figure 5.16. | RTRL Procedure.....                                    | 99  |
| 5.21.        | Combination of Methods. ....                           | 99  |
| Figure 5.17. | Combination of Methods. ....                           | 100 |
| 5.22.        | Diverse Vector Area (DVA). ....                        | 100 |
| Figure 5.18. | Diverse Vector Area. ....                              | 101 |
| 5.23.        | Specific ATC Departure Instructions. ....              | 101 |
| 5.24.        | Standard Instrument Departure (SID). ....              | 101 |
| Figure 5.19. | Civil SID with Top Altitude. ....                      | 102 |
| 5.25.        | SID Clearances. ....                                   | 103 |

|  |       |   |            |
|--|-------|---|------------|
| Table  | 5.4.  | NAS SID Phraseology. ....   | 103        |
| Table  | 5.5.  | ICAO SID Phraseology. ....  | 104        |
|  | 5.26. | Military SID. ....  | 104        |
| Figure   | 5.20. | Military SID. ....  | 105        |
|  | 5.27. | Civil SID. ....   | 105        |
| Figure   | 5.21. | Civil SID. ....   | 106        |
|  | 5.28. | ICAO SID. ....  | 106        |
| Table  | 5.6.  | ICAO Maximum Speeds for “Turning Departures”. ....  | 106        |
| Table  | 5.7.  | Departure Minimums and Departure Alternate Requirements for<br>Tanker/Transport/Bomber Aircraft. .... | 107        |
|  | 5.29. | Vector SID. ....  | 107        |
| Figure   | 5.22. | Radar Vector SID. ....  | 108        |
|  | 5.30. | MAJCOM-Certified Departure. ....  | 108        |
|  | 5.31. | Special Departure Procedure (SDP). ....   | 108        |
| Figure   | 5.23. | Albuquerque ODP (Runway 8). ....  | 109        |
| Figure   | 5.24. | Albuquerque SDP (Runway 8). ....  | 109        |
|  | 5.32. | RNAV Departures. ....   | 109        |
| Figure   | 5.25. | RNAV Departure Procedures. ....   | 110        |
| <b>Chapter 6— PERFORMANCE-BASED NAVIGATION</b> |       |   | <b>111</b> |
|  | 6.1.  | General. ....   | 111        |
| Figure   | 6.1.  | Progression from Sensor-based to Performance-based Navigation. ....                                   | 111        |
|  | 6.2.  | Area Navigation (RNAV) Operations and RNP Operations. ....  | 111        |
|  | 6.2.  | Area Navigation (RNAV) Operations and RNP Operations. ....  | 111        |
|  | 6.3.  | PBN Context. ....   | 112        |
|  | 6.4.  | Fundamental PBN Concepts. ....  | 112        |
|  | 6.5.  | Navigation Functional Requirements. ....  | 112        |
|  | 6.6.  | Designation of RNAV Specifications and RNP Specifications. ....                                       | 112        |
| Figure   | 6.2.  | Navigation Specification Designations. ....   | 113        |
| Figure   | 6.3.  | Lateral Navigation Errors. ....   | 114        |

|  |  |            |
|--|--|------------|
| 6.7.   | RNAV Designations and RNP Designations. ....                   | 114        |
| Figure 6.4.  | RNAV Designations vs RNP Designations. ....                    | 115        |
| 6.8.   | On-board Performance Monitoring and Alerting. ....             | 115        |
| <b>Chapter 7— PERFORMANCE-BASED COMMUNICATION AND SURVEILLANCE</b> |  | <b>116</b> |
| 7.1.   | General. ....  | 116        |
| 7.2.   | PBCS Operations. ....  | 116        |
| 7.2.   | PBCS Operations. ....  | 116        |
| 7.3.   | PBCS Context. ....   | 116        |
| Figure 7.1.  | Performance-based ATM Model. ....                              | 116        |
| 7.4.   | RCP Specifications. ....                                       | 116        |
| 7.5.   | Actual Communication Performance (ACP). ....                   | 117        |
| Figure 7.2.  | Actual Communications Performance (ACP). ....                  | 117        |
| 7.6.   | RSP Specifications. ....                                       | 117        |
| <b>Chapter 8— GROUND-BASED NAVIGATION AIDS</b>                     |  | <b>118</b> |
| 8.1.   | General. ....  | 118        |
| 8.2.   | Reporting Malfunctions. ....                                   | 118        |
| 8.3.   | Using Ground-based NAVAIDs. ....                               | 118        |
| 8.4.   | VOR Minimum Operational Network (MON). ....                    | 118        |
| 8.5.   | TACAN. ....  | 118        |
| 8.6.   | Instrument Landing System (ILS). ....                          | 119        |
| 8.7.   | Localizer (LOC). ....  | 119        |
| <b>Chapter 9— SPACE-BASED NAVIGATION AIDS</b>                      |  | <b>120</b> |
| 9.1.   | General. ....  | 120        |
| 9.2.   | Reporting Malfunctions. ....                                   | 120        |
| 9.3.   | Global Positioning System (GPS). ....                          | 120        |
| 9.4.   | Globalnaya Navigazionnaya Sputnikovaya Sistema (GLONASS). .... | 121        |
| 9.5.   | Aircraft-based Augmentation System (ABAS). ....                | 121        |
| 9.6.   | RAIM. ....   | 121        |
| 9.7.   | Satellite-Based Augmentation System (SBAS). ....               | 122        |

|                                      |   |            |
|--------------------------------------|---|------------|
| 9.8.                                 | SBAS Avionics. ....   | 122        |
| 9.9.                                 | SBAS Coverage and Service Areas. ....                         | 122        |
| 9.10.                                | Ground Based Augmentation System (GBAS). ....                 | 123        |
| Figure 9.1.                          | GBAS Landing System (GLS) Approach.....                       | 124        |
| 9.11.                                | GBAS Avionics. ....   | 124        |
| <b>Chapter 10— INSTRUMENT CHARTS</b> |   | <b>125</b> |
| 10.1.                                | General. ....   | 125        |
| 10.2.                                | Ground Track. ....  | 125        |
| 10.3.                                | Instrument Procedure Design Criteria. ....                    | 125        |
| Figure 10.1.                         | Instrument Procedure Design Criteria – U.S. Government. ....  | 126        |
| Figure 10.2.                         | Instrument Procedure Design Criteria – Jeppesen®. ....        | 126        |
| 10.4.                                | Waypoints. ....   | 126        |
| Figure 10.3.                         | Fly-by versus Fly-over Waypoint. ....                         | 127        |
| 10.5.                                | Radius-to-Fix (RF). ....                                      | 127        |
| Figure 10.4.                         | Radius-to-Fix (RF) Legs.....                                  | 129        |
| 10.6.                                | High Performance Military Aircraft (HPMA) Criteria. ....      | 130        |
| 10.7.                                | Chart Reference Number. ....                                  | 130        |
| Figure 10.5.                         | DoD Published Foreign Instrument Procedure. ....              | 131        |
| 10.8.                                | Foreign Terminal Instrument Procedure (FTIP). ....            | 131        |
| 10.9.                                | Non-U.S. Government Published Instrument Procedures. ....     | 131        |
| 10.10.                               | FTIP Review Request. ....                                     | 132        |
| 10.11.                               | Comparison Evaluation for Commercially-Produced Products..... | 132        |
| 10.12.                               | NGA Electronic – Instrument Procedure Library (E-IPL). ....   | 132        |
| <b>Chapter 11— WAKE TURBULENCE</b>   |   | <b>134</b> |
| 11.1.                                | General. ....   | 134        |
| 11.2.                                | Aircraft Weight Classes. ....                                 | 134        |
| 11.3.                                | [ICAO] Wake Turbulence Separation. ....                       | 134        |
| Table 11.1.                          | ICAO Distance-based Wake Turbulence Minima. ....              | 135        |
| Table 11.2.                          | ICAO Time-based Wake Turbulence Minima.....                   | 135        |



|                                       |        |  |            |
|---------------------------------------|--------|--|------------|
|                                       | 11.4.  | European Wake Vortex Re-categorization (RECAT-EU). ..... | 136        |
| Figure                                | 11.1.  | RECAT-EU Categories.....                                 | 137        |
| Table                                 | 11.3.  | RECAT-EU Distance-based Wake Turbulence Minima. ....     | 137        |
| Table                                 | 11.4.  | RECAT-EU Time-based Wake Turbulence Minima.....          | 138        |
|                                       | 11.5.  | [NAS Only] Wake Turbulence Separation. ....              | 138        |
| <b>Chapter 12— ENROUTE NAVIGATION</b> |        |  | <b>140</b> |
|                                       | 12.1.  | Airspace and Airspace Classification. ....               | 140        |
|                                       | 12.2.  | Oceanic and Remote Continental Airspace. ....            | 140        |
|                                       | 12.3.  | Minimum Aircraft Altitude.....                           | 141        |
|                                       | 12.4.  | Aircraft Speed. ....                                     | 142        |
|                                       | 12.5.  | Hazard Avoidance.....                                    | 143        |
|                                       | 12.6.  | VFR Flight. ....   | 143        |
| Table                                 | 12.1.  | NAS VFR Cloud Clearance and Visibility Minimums.....     | 144        |
| Table                                 | 12.2.  | ICAO VFR Cloud Clearance and Visibility Minimums.....    | 144        |
|                                       | 12.7.  | Low-Level and VFR Charts. ....                           | 145        |
|                                       | 12.8.  | Definitions. ....  | 145        |
| Figure                                | 12.1.  | Applying Magnetic Variation. ....                        | 146        |
|                                       | 12.9.  | Chart Selection. ....                                    | 146        |
|                                       | 12.10. | Chart Hazards. ....                                      | 147        |
|                                       | 12.11. | Chart Building Requirements. ....                        | 148        |
|                                       | 12.11. | Chart Building Requirements. ....                        | 148        |
|                                       | 12.12. | Route Development. ....                                  | 149        |
|                                       | 12.13. | Route Navigation. ....                                   | 150        |
|                                       | 12.14. | Chart Reading. ....                                      | 151        |
| Figure                                | 12.2.  | Maximum Elevation Note – Unreliable Relief. ....         | 151        |
|                                       | 12.15. | On-Board Navigation Systems. ....                        | 152        |
|                                       | 12.16. | Low-Level Time-to-Impact. ....                           | 152        |
| Table                                 | 12.3.  | Time-to-Impact (seconds) – Wings Level. ....             | 152        |
| Table                                 | 12.4.  | Time-to-Impact (seconds) – Banked.....                   | 153        |

|                    |  |            |
|--------------------|--|------------|
|                    | 12.17. Route Abort. ....                                 | 153        |
| <b>Chapter 13—</b> | <b>HOLDING</b>   | <b>154</b> |
|                    | 13.1. General. ....                                      | 154        |
|                    | 13.2. Holding Patterns. ....                             | 154        |
| Figure 13.1.       | Standard Holding Pattern.....                            | 154        |
|                    | 13.3. Holding Instructions. ....                         | 154        |
| Figure 13.2.       | Multiple Holding Patterns at Same Fix.....               | 155        |
|                    | 13.4. Holding Entry. ....                                | 155        |
| Figure 13.3.       | Holding Entry Sectors.....                               | 155        |
|                    | 13.5. Holding Bank Angle. ....                           | 155        |
|                    | 13.6. Maximum Holding Airspeed. ....                     | 156        |
| Table 13.1.        | Maximum Holding Airspeeds.....                           | 156        |
| Figure 13.4.       | Maximum Holding Airspeed. ....                           | 157        |
|                    | 13.7. Holding Length. ....                               | 157        |
| Figure 13.5.       | ICAO Limiting Radial. ....                               | 158        |
|                    | 13.8. Drift Corrections. ....                            | 158        |
|                    | 13.9. Fuel Consideration. ....                           | 158        |
|                    | 13.10. Use of Area Navigation Guidance and Holding. .... | 158        |
| <b>Chapter 14—</b> | <b>ARRIVAL</b>   | <b>159</b> |
|                    | 14.1. General. ....                                      | 159        |
|                    | 14.2. Weather. ....                                      | 159        |
|                    | 14.3. Types of Instrument Arrivals. ....                 | 159        |
|                    | 14.4. VFR Arrival. ....                                  | 159        |
|                    | 14.5. Descent Planning. ....                             | 159        |
|                    | 14.6. Initial Descent. ....                              | 159        |
|                    | 14.7. ICAO Arrival Routing. ....                         | 160        |
|                    | 14.8. Standard Terminal Arrivals (STAR). ....            | 160        |
|                    | 14.9. Arrival Clearances. ....                           | 160        |
|                    | 14.10. Arrival Phraseology. ....                         | 160        |

|                             |        |  |            |
|-----------------------------|--------|--|------------|
| Table                       | 14.1.  | NAS Phraseology.....                             | 161        |
| Table                       | 14.2.  | ICAO Phraseology.....                            | 162        |
|                             | 14.11. | RNAV Arrivals. ....                              | 162        |
| Figure                      | 14.1.  | RNAV Arrival.....                                | 163        |
|                             | 14.12. | Anticipated Approach. ....                       | 163        |
|                             | 14.13. | Terminal Routings. ....                          | 163        |
|                             | 14.14. | Terminal Arrival Area (TAA). ....                | 164        |
|                             | 14.15. | Radar Vectors. ....                              | 164        |
|                             | 14.16. | Operating at Non-towered Airfields. ....         | 165        |
| <b>Chapter 15— APPROACH</b> |        |  | <b>166</b> |
|                             | 15.1.  | General. ....                                    | 166        |
|                             | 15.2.  | Practice Instrument Approaches Under VFR. ....   | 166        |
|                             | 15.2.  | Practice Instrument Approaches Under VFR. ....   | 166        |
|                             | 15.3.  | Instrument Approaches. ....                      | 166        |
| Table                       | 15.1.  | Helicopter Use of Approach Procedures.....       | 168        |
|                             | 15.4.  | Approach Minimums. ....                          | 168        |
|                             | 15.5.  | Inoperative Approach Lighting System (ALS). .... | 168        |
|                             | 15.6.  | Approach Clearance. ....                         | 168        |
|                             | 15.7.  | Aircraft Speed. ....                             | 169        |
| Table                       | 15.2.  | ICAO Maximum Speeds.....                         | 169        |
|                             | 15.8.  | Approach Chart Naming Convention. ....           | 169        |
|                             | 15.9.  | Duplicate Procedure Identification. ....         | 170        |
|                             | 15.10. | Circling-Only Approach. ....                     | 170        |
|                             | 15.11. | Equipment Required for an Approach. ....         | 170        |
| Figure                      | 15.1.  | Equipment Required for an Approach. ....         | 171        |
| Figure                      | 15.2.  | Additional Equipment Required for Approach.....  | 172        |
|                             | 15.12. | Radar Approaches. ....                           | 172        |
| Figure                      | 15.3.  | Radar Approach Minimums.....                     | 173        |
|                             | 15.13. | Non-radar Approaches. ....                       | 173        |

|        |        |   |     |
|--------|--------|---|-----|
|        | 15.14. | Reading an Instrument Procedure. ....                                   | 173 |
| Figure | 15.4.  | Instrument Approach Chart.....  | 174 |
| Figure | 15.5.  | Minimum Sector Altitude with Sub-sector Based on Distance. ....         | 175 |
|        | 15.15. | Radar Fixes on Non-radar Approaches. ....                               | 176 |
| Figure | 15.6.  | Radar Fix on Non-radar Approach. ....                                   | 176 |
|        | 15.16. | PBN Transitions to Conventional Final Approach. ....                    | 176 |
| Figure | 15.7.  | PBN Transitions to Conventional Final Approach. ....                    | 178 |
|        | 15.17. | RNAV Lines of Minima. ....  | 178 |
| Figure | 15.8.  | RNAV Lines of Minima. ....  | 179 |
|        | 15.18. | Baro-VNAV Systems. ....   | 180 |
|        | 15.19. | Baro-VNAV Temperature Limitations. ....                                 | 180 |
| Figure | 15.9.  | Baro-VNAV Temperature Limits. ....                                      | 180 |
|        | 15.20. | Approach Segments. ....   | 180 |
| Figure | 15.10. | Approach Segments. ....   | 181 |
| Figure | 15.11. | Instrument Procedure without a Charted IF.....                          | 182 |
|        | 15.21. | Dead Reckoning Segment. ....  | 182 |
| Figure | 15.12. | [ICAO] Dead Reckoning Segment. ....                                     | 183 |
|        | 15.22. | Instrument Approach Segment Descents. ....                              | 183 |
|        | 15.23. | Established on Track. ....  | 183 |
|        | 15.24. | Shuttle, Climb-in Hold, and Descent-in Hold. ....                       | 183 |
|        | 15.25. | Types of Course Reversals. ....   | 184 |
| Figure | 15.13. | Types of Course Reversals.....  | 184 |
|        | 15.26. | ICAO-Specific Course Reversal and Racetrack Procedures. ....            | 184 |
| Figure | 15.14. | Direct Entry Sector. ....   | 185 |
| Figure | 15.15. | Base Turn Entry Expanded Entry Sector.....                              | 185 |
| Figure | 15.16. | ICAO PANS-OPS versus U S TERPS Protected Airspace. ....                 | 186 |
| Table  | 15.3.  | ICAO Course Reversal and Racetrack Descent Rates. ....                  | 186 |
| Table  | 15.4.  | ICAO Maximum Speeds for Course Reversals and Racetrack Procedures. .... | 187 |
|        | 15.27. | Procedure Turn. ....  | 187 |

|               |   |     |
|---------------|---|-----|
| Figure 15.17. | Procedure Turn. ....                            | 188 |
| Figure 15.18. | Procedure Turn Not Authorized.....              | 189 |
| Figure 15.19. | Procedure Turn with No FAF Depicted.....        | 191 |
| Figure 15.20. | Procedure Turn Fix Altitude. ....               | 192 |
| 15.28.        | Procedure Turn - 45°/180°. ....                 | 192 |
| Figure 15.21. | 45°/180° Procedure Turn. ....                   | 193 |
| 15.29.        | Procedure Turn – 80°/260°. ....                 | 193 |
| Figure 15.22. | 80°/260° Procedure Turn. ....                   | 193 |
| 15.30.        | Base Turn or (NAS Only) Teardrop. ....          | 194 |
| Figure 15.23. | Base Turn or (NAS Only) Teardrop. ....          | 194 |
| Figure 15.24. | Base Turn with More Than One Track. ....        | 195 |
| 15.31.        | Racetrack or (NAS Only) HILPT. ....             | 195 |
| Figure 15.25. | Racetrack or (NAS Only) HILPT. ....             | 196 |
| Figure 15.26. | HILPT Approach. ....                            | 197 |
| 15.32.        | Limitations on Procedure Turns (NAS Only). .... | 197 |
| Figure 15.27. | [NAS Only] NoPT Routing. ....                   | 198 |
| 15.33.        | Stepdown Fixes. ....                            | 198 |
| Figure 15.28. | Instrument Procedure Stepdown Fixes. ....       | 199 |
| 15.34.        | High Altitude Approaches. ....                  | 199 |
| 15.35.        | Non-DME Teardrop High Altitude Approach. ....   | 199 |
| Figure 15.29. | Non-DME Teardrop High Altitude Approach.....    | 201 |
| 15.36.        | Helicopter-Only Approaches. ....                | 201 |
| Figure 15.30. | Helicopter-Only Approach.....                   | 202 |
| Figure 15.31. | Short Final Approach.....                       | 203 |
| Figure 15.32. | Point-in-Space (PinS) Approach.....             | 204 |
| Figure 15.33. | PinS Approach to Multiple Heliports. ....       | 205 |
| 15.37.        | MAJCOM-Certified Approach. ....                 | 205 |
| 15.38.        | Visual Approach. ....                           | 205 |
| 15.39.        | Contact Approach (NAS Only). ....               | 206 |

|                                   |   |            |
|-----------------------------------|---|------------|
|                                   | 15.40. Charted Visual Flight Procedures. ....               | 207        |
| Figure                            | 15.34. Charted Visual Flight Procedure.....                 | 208        |
|                                   | 15.41. Simultaneous Approaches to Parallel Runways. ....    | 208        |
| Figure                            | 15.35. Simultaneous Approaches to Parallel Runways.....     | 209        |
|                                   | 15.42. Simultaneous Dependent Approaches. ....              | 210        |
| Figure                            | 15.36. Simultaneous Dependent Approaches. ....              | 210        |
|                                   | 15.43. Simultaneous Independent Approaches. ....            | 210        |
| Figure                            | 15.37. Simultaneous (Parallel) Independent Approaches. .... | 211        |
|                                   | 15.44. Simultaneous Converging Instrument Approaches. ....  | 211        |
| Figure                            | 15.38. Simultaneous Converging Instrument Approach.....     | 211        |
| <b>Chapter 16— FINAL APPROACH</b> |   | <b>212</b> |
|                                   | 16.1. General. ....   | 212        |
|                                   | 16.2. Final Approach Components. ....                       | 212        |
|                                   | 16.3. Visual Descent Point (VDP). ....                      | 212        |
| Figure                            | 16.1. VDP. ....   | 213        |
|                                   | 16.4. Vertical Descent Angle (VDA). ....                    | 213        |
| Figure                            | 16.2. Visual Segment – Obstacles.....                       | 213        |
| Figure                            | 16.3. Descent Angle NA.....                                 | 213        |
|                                   | 16.5. Continuous Descent Final Approach (CDFA). ....        | 214        |
| Figure                            | 16.4. Dive and Drive.....                                   | 215        |
| Figure                            | 16.5. CDFA.....   | 215        |
| Figure                            | 16.6. Find Descent Gradient. ....                           | 216        |
| Figure                            | 16.7. Find Descent Rate.....                                | 217        |
| Figure                            | 16.8. KTLH VOR 18. ....                                     | 218        |
| Figure                            | 16.9. Calculating a CDFA Descent Point beyond the FAF. .... | 218        |
|                                   | 16.6. Flying the Approach. ....                             | 219        |
|                                   | 16.7. Runway Environment. ....                              | 219        |
|                                   | 16.8. ILS or LOC. ....                                      | 219        |
|                                   | 16.9. RNAV (GPS) and GPS Approach Procedures.....           | 221        |

|   |  |            |
|---|--|------------|
| 16.10.  | Visual Segment. ....   | 221        |
| Figure 16.10.   | Visual Segment. ....   | 222        |
| <b>Chapter 17— SPECIAL AIRCREW AND AIRCRAFT CERTIFICATION REQUIRED APPROACHES</b> |  | <b>223</b> |
| 17.1.   | General. ....  | 223        |
| 17.2.   | Special Authorization Category I (SA CAT I). ....  | 223        |
| Figure 17.1.  | SA CAT I ILS Approach. ....  | 223        |
| 17.3.   | Category II (CAT II). ....   | 223        |
| Figure 17.2.  | CAT II ILS Approach. ....  | 224        |
| 17.4.   | “Copter” Category II. ....   | 224        |
| Figure 17.3.  | COPTER CAT II ILS Approach. ....   | 225        |
| 17.5.   | Special Authorization Category II with Reduced Lighting (SA CAT II). ....                            | 225        |
| Figure 17.4.  | SA CAT II ILS Approach. ....   | 226        |
| 17.6.   | Category III (CAT III). ....   | 226        |
| Figure 17.5.  | CAT III ILS Approach. ....   | 227        |
| 17.7.   | Simultaneous Close Parallel ILS Precision Runway Monitor (PRM) / RNAV PRM / GLS PRM Approaches. .... | 227        |
| 17.8.   | Simultaneous Offset Instrument Approaches (SOIA). ....   | 227        |
| 17.9.   | RNP Authorization Required (AR) Approach Procedures. ....  | 228        |
| Figure 17.6.  | RNP Values. ....   | 228        |
| Figure 17.7.  | Nonstandard Missed Approach Climb Gradient. ....   | 229        |
| Figure 17.8.  | Aircraft Size Restrictions. ....   | 230        |
| Figure 17.9.  | RNP Parallel Approach Operations. ....   | 231        |
| Figure 17.10.   | RNP Parallel Approach Runway Transition Operations. ....   | 231        |
| Figure 17.11.   | RNP Converging Runway Operations. ....   | 232        |
| <b>Chapter 18— LANDING</b>  |  | <b>233</b> |
| 18.1.   | General. ....  | 233        |
| 18.2.   | Land and Hold Short Operations (LAHSO). ....   | 233        |
| 18.3.   | Reduced Same Runway Separation (RSRS). ....  | 233        |

|                                    |        |   |            |
|------------------------------------|--------|---|------------|
|                                    | 18.3.  | Reduced Same Runway Separation. ....                          | 233        |
|                                    | 18.4.  | Helicopter Landing Areas. ....                                | 233        |
|                                    | 18.5.  | Landing With Hot Armament. ....                               | 233        |
|                                    | 18.5.  | Landing with Hot Armament. ....                               | 233        |
|                                    | 18.6.  | Touch-and-Go Landings. ....                                   | 233        |
|                                    | 18.6.  | Touch-and-Go Landings. ....                                   | 233        |
|                                    | 18.7.  | Turns after Touch-and-Go or Low Approach. ....                | 233        |
|                                    | 18.8.  | Traffic Pattern. ....   | 233        |
|                                    | 18.9.  | Illusions and Vision in Flight. ....                          | 234        |
|                                    | 18.10. | Approach Lighting Systems (ALS). ....                         | 235        |
|                                    | 18.11. | Runway Lighting Systems. ....                                 | 235        |
|                                    | 18.12. | Runway Markings. ....   | 235        |
|                                    | 18.13. | Circling Approaches. ....                                     | 235        |
|                                    | 18.14. | Circling Protected Area. ....                                 | 236        |
| Figure                             | 18.1.  | Circling Approach Area.....                                   | 236        |
| Table                              | 18.1.  | US TERPS Standard Circling Criteria.....                      | 236        |
| Figure                             | 18.2.  | Expanded Circling Area Annotation.....                        | 237        |
| Table                              | 18.2.  | US TERPS Expanded Circling Approach Maneuvering Airspace..... | 237        |
| Table                              | 18.3.  | PANS-OPS Circling Area Radii.....                             | 238        |
| Figure                             | 18.3.  | Circling Maneuver Examples.....                               | 238        |
|                                    | 18.15. | Accomplishing the Circling Maneuver. ....                     | 239        |
|                                    | 18.16. | [ICAO] Visual Maneuver Using a Prescribed Track. ....         | 239        |
| Table                              | 18.4.  | Semi-Width of the Corridor.....                               | 240        |
| Figure                             | 18.4.  | Visual Maneuver Using a Prescribed Track Protected Area.....  | 240        |
|                                    | 18.17. | Side-Step Maneuver. ....                                      | 240        |
| Figure                             | 18.5.  | Published Side-Step Minimums.....                             | 241        |
| <b>Chapter 19— MISSED APPROACH</b> |        |   | <b>242</b> |
|                                    | 19.1.  | General. ....   | 242        |
|                                    | 19.2.  | Missed Approach. ....   | 242        |



|  |        |   |            |
|--|--------|---|------------|
|  | 19.3.  | ICAO Bank Angle. ....                                     | 242        |
|  | 19.4.  | Missed Approach Instructions. ....                        | 242        |
|  | 19.5.  | ATC Notification. ....                                    | 242        |
|  | 19.6.  | Missed Approach Airspeed. ....                            | 242        |
| Table  | 19.1.  | ICAO Maximum Missed Approach Speed. ....                  | 243        |
|  | 19.7.  | Missed Approach Phases. ....                              | 243        |
|  | 19.8.  | Turning Missed Approach. ....                             | 243        |
|  | 19.9.  | RNAV Missed Approach. ....                                | 244        |
|  | 19.10. | Radar Approaches. ....                                    | 244        |
|  | 19.11. | CDFA Missed Approach Procedures. ....                     | 244        |
|  | 19.12. | Early Missed Approach Initiation. ....                    | 244        |
| Figure   | 19.1.  | Early Missed Approach Restriction. ....                   | 245        |
|  | 19.13. | Delayed Missed Approach Decision. ....                    | 246        |
|  | 19.14. | Loss of Visual Reference While Circling. ....             | 246        |
| Figure   | 19.2.  | Missed Approach from the Circling Approach. ....          | 247        |
|  | 19.15. | Training – Multiple Approaches. ....                      | 247        |
| <b>Chapter 20— EXTREME LATITUDE NAVIGATION</b> |        |   | <b>248</b> |
|  | 20.1.  | General. ....   | 248        |
| Figure   | 20.1.  | Heading Indications While Crossing Meridians. ....        | 249        |
|  | 20.2.  | Boundaries of the AMU. ....                               | 249        |
|  | 20.3.  | Grid Operations. ....                                     | 249        |
|  | 20.4.  | Definition of an Emergency in the AMU. ....               | 250        |
|  | 20.5.  | Using the VOR in the AMU. ....                            | 251        |
|  | 20.6.  | Using an NDB in the AMU. ....                             | 252        |
|  | 20.7.  | Enroute Navigation at High Latitudes. ....                | 252        |
| Figure   | 20.2.  | Enroute Charts for Navigation at Higher Latitudes. ....   | 253        |
| Figure   | 20.3.  | Canadian Artic, Northern and Southern Control Areas. .... | 254        |
|  | 20.8.  | True North Enroute Procedures. ....                       | 254        |
|  | 20.9.  | Chart Reading in High Latitudes. ....                     | 255        |

|   |            |
|---|------------|
| <b>Attachment 1— GLOSSARY OF REFERENCES AND SUPPORTING INFORMATION</b>            | <b>257</b> |
| <b>Attachment 2— THE “60-TO-1 RULE”</b>   | <b>285</b> |
| <b>Attachment 3— General Turning Performance (Constant Altitude, Steady Turn)</b> | <b>293</b> |
| <b>Attachment 4— INSTRUMENT FLYING FUNDAMENTALS</b>                               | <b>294</b> |
| <b>Attachment 5— INSTRUMENT MANEUVERS</b>   | <b>300</b> |

## Chapter 1

### OVERVIEW

**1.1. General.** This manual provides broad guidance for aircraft operations. It is consolidated to help aviators to identify and synthesize potentially applicable standards and procedures, and to understand application and waiver authority. General guidance cannot address every situation, therefore, Major Commands (MAJCOMs) and wing commanders should provide additional guidance further supporting safe aircraft operations. In the absence of specific guidance, aircrew will seek clarification and use sound judgment.

#### 1.2. Scope.

1.2.1. This manual consolidates guidance for pilots, such as found in the U.S. Code of Federal Regulations (CFR), DoD Directives and Instructions, and other United States Air Force (USAF) guidance for pilots. Supplemental information to this AFMAN may be found in applicable MAJCOM supplements.

1.2.2. Unmanned Aircraft System (UAS) or Remotely Piloted Aircraft applicability. Category 4 and 5 UAS operations shall follow this AFMAN. AFMAN 11-502, *Small Unmanned Aircraft Systems*, shall govern Category 1-3 (“Small”) UAS operations. UAS categories are listed in AFMAN 11-502.

1.2.3. Basic civil aviation information for the national airspace system (NAS) available in the Aeronautical Information Manual (AIM) is not duplicated in this manual; additional information is available in FAA-H-8083-15, *Instrument Flying Handbook*, FAA-H-8083-16, *Instrument Procedures Handbook*, and FAA-H-8083-25, *Pilot’s Handbook of Aeronautical Knowledge*. FAA handbooks and resources may be found on the FAA website at [https://www.faa.gov/regulations\\_policies/handbooks\\_manuals/aviation/](https://www.faa.gov/regulations_policies/handbooks_manuals/aviation/).

1.2.4. Differences between USAF and FAA aviation information are provided in this manual; [DoDI 4540.01, Use of International Airspace by U.S. Military Aircraft and for Missile and Projectile Firing] International Civil Aviation Organization (ICAO) aviation information, which U.S. military pilots must observe when practical and compatible with the mission, is also duplicated for ease of access. When compliance with ICAO procedures is not practical and consistent with the mission, U.S. military pilots must operate with due regard IAW Flight Information Publication (FLIP) *General Planning*, Chapter 8. Items that are specific to the NAS are annotated accordingly (e.g., “(NAS Only)”).

1.2.5. This manual provides broad guidance for Air Force flying under most circumstances. Pilots should exercise sound judgment to safely conduct flying operations if something is not expressly prohibited in this manual.

1.2.6. The intended audience for this manual is winged, post-undergraduate pilot training USAF pilots. Basic flight fundamentals are described in [Attachment 2](#), [Attachment 3](#), [Attachment 4](#), [Attachment 5](#), FAA-H-8083-3, *Airplane Flying Handbook*, FAA-H-8083-25, *Pilot’s Handbook of Aeronautical Knowledge*, and FAA-H-8083-16, *Instrument Procedures Handbook*.

**1.3. References to Source Material.** Pilots must reference and be familiar with the specific cited references to the AIM contained within this manual. (T-1). References other than the AIM are for

information and educational use only, and are not in all circumstances binding on military aircraft operations. Questions about the applicability of any cited references or documents contained herein to specific activities should be routed through applicable MAJCOM/A3 channels to HQ AFFSA. HQ AFFSA shall in turn seek clarification regarding applicability from the relevant USAF legal office.

1.3.1. All references are provided inside square brackets and listed without any applicable suffix or version (e.g., “[FAA Order 8260.3]”). References at the beginning of a paragraph apply to the entire paragraph; references at the end of a sentence apply only to that sentence.

1.3.2. This manual is current as of its publication date for the references in **Attachment 1**; however, if a newer version is current, then pilots should refer to the current version (e.g., FAA Order 8260.3D is referenced and FAA Order 8260.3E is current). **Note:** For AIM references, the intent is the subject paragraph referenced, not simply the number. **Example:** If the FAA revises AIM 5-4-1, *Standard Terminal Arrival (STAR) Procedures* to 5-5-1, the intent is to reference the *STAR Procedures* information, not simply the paragraph number.

1.3.3. This manual uses the generic term “aircraft flight manual” when referring to mission design series (MDS) flight manuals whether an aircraft MDS uses an airplane flight manual or technical order (T.O.) or is an airplane, helicopter, etc.

1.3.4. When referencing the pilot in command (PIC) throughout this manual, the PIC is the final authority for the compliance statements. The PIC may delegate a task but retains responsibility for compliance.

1.3.5. MAJCOMs may reference FAA documents, listed in **Attachment 1**, when developing training, guidance, and operational execution procedures to comply with the intent of this manual.

1.3.5.1. AC 20-131, *Airworthiness Approval of Traffic Alert and Collision Avoidance Systems (TCAS-II) and Mode S Transponders*.

1.3.5.2. AC 20-138, *Airworthiness Approval of Positioning and Navigation Systems*.

1.3.5.3. AC 20-140, *Guidelines for Design Approval of Aircraft Data Link Communication Systems Supporting Air Traffic Services (ATS)*.

1.3.5.4. AC 20-150, *Airworthiness Approval of Satellite Voice (SATVOICE) Equipment Supporting Air Traffic Service (ATS) Communication*.

1.3.5.5. AC 20-151, *Airworthiness Approval of Traffic Alert and Collision Avoidance Systems (TCAS II), Versions 7.0 & 7.1 and Associated Mode S Transponders*.

1.3.5.6. AC 20-165, *Airworthiness Approval of Automatic Dependent Surveillance - Broadcast OUT Systems*.

1.3.5.7. AC 20-167, *Airworthiness Approval of Enhanced Vision System, Synthetic Vision System, Combined Vision System, and Enhanced Flight Vision System Equipment*.

1.3.5.8. AC 20-172, *Airworthiness Approval for ADS-B In Systems and Applications*.

1.3.5.9. AC 90-23, *Aircraft Wake Turbulence*.

1.3.5.10. AC 90-91, *North American Route Program*.

- 1.3.5.11. AC 90-96, *Approval of U.S. Operators and Aircraft to Operate Under Instrument Flight Rules (IFR) in European Airspace Designated for Basic Area Navigation (B-RNAV) and Precision Area Navigation (P-RNAV)*.
- 1.3.5.12. AC 90-100, *U.S. Terminal and En Route Area Navigation (RNAV) Operations*.
- 1.3.5.13. AC 90-101, *Approval Guidance for RNP Procedures with AR*.
- 1.3.5.14. AC 90-105, *Approval Guidance for RNP Operations and Barometric Vertical Navigation in the U.S. National Airspace System and in Oceanic and Remote Continental Airspace*.
- 1.3.5.15. AC 90-106, *Enhanced Flight Vision Systems*.
- 1.3.5.16. AC 90-107, *Guidance for Localizer Performance with Vertical Guidance and Localizer Performance without Vertical Guidance Approach Operations in the U.S. National Airspace System*.
- 1.3.5.17. AC 90-108, *Use of Suitable Area Navigation (RNAV) Systems on Conventional Routes and Procedures*.
- 1.3.5.18. AC 90-114, *Automatic Dependent Surveillance-Broadcast Operations*.
- 1.3.5.19. AC 90-117, *Data Link Communications*.
- 1.3.5.20. AC 91-70, *Oceanic and Remote Continental Airspace Operations*.
- 1.3.5.21. AC 91-85, *Authorization of Aircraft and Operators for Flight in Reduced Vertical Separation Minimum (RVSM) Airspace*.
- 1.3.5.22. AC 120-28, *Criteria for Approval of Category III Weather Minima for Takeoff, Landing, and Rollout*.
- 1.3.5.23. AC 120-29, *Criteria for Approval of Category I and Category II Weather Minima for Approach*.
- 1.3.5.24. AC 120-76, *Authorization for Use of Electronic Flight Bags*.
- 1.3.5.25. ICAO Doc 8400, *ICAO Abbreviations and Codes*.
- 1.3.5.26. Title 14, Code of Federal Regulations, Part 1, *Definitions and Abbreviations*, Current Edition.
- 1.3.5.27. Title 14, Code of Federal Regulations, Part 91, *General Operating and Flight Rules*, Current Edition.
- 1.3.5.28. Title 14, Code of Federal Regulations, Part 121, *Operating Requirements: Domestic, Flag, and Supplemental Operations*, Current Edition.
- 1.3.5.29. Title 14, Code of Federal Regulations, Part 135, *Operating Requirements: Commuter and on Demand Operations and Rules Governing Persons on Board Such Aircraft*, Current Edition.

**1.4. Flight Operations in International Airspace.** [DoDI 4540.01] International airspace exists over the high seas at any point greater than 12 nautical miles from baseline of coastal state. See FLIP GP for DoD policy and procedures for flight operations in international airspace. **Note:** Aircrew operating U.S. military aircraft within international airspace will ensure aircraft do not

comply with a State's requirements for those areas the United States considers excessive claims under international law. (T-0). For a summary of claims considered excessive see the Maritime Claims Reference Manual ([http://www.jag.navy.mil/organization/code\\_10\\_mcrm.htm](http://www.jag.navy.mil/organization/code_10_mcrm.htm)).

**1.5. Flight Operation in Foreign Airspace.** ICAO member states publish their exceptions to ICAO publications in their individual *Aeronautical Information Publication (AIP)* (<https://asps.leidos.com/>). FLIP *Area Planning (AP)* (<https://aerodata.nga.mil/AeroDownload/?section=flip>). and the *Foreign Clearance Guide (FCG)* (<https://www.fcg.pentagon.mil/fcg.cfm>) should extract pertinent information from these AIPs. Refer to diplomatic clearances and the FCG for specific guidance on operation in foreign sovereign airspace.

1.5.1. Sovereignty of US Military Aircraft. DoD aircraft commanders must not authorize any exercise of jurisdiction by foreign authorities except by direction of the appropriate DoD component headquarters or the US Embassy [FCG] (T-0).

1.5.2. US military aircraft are sovereign instrumentalities. When they have received diplomatic clearance to land in foreign territory, it is US policy to assert that they are entitled to the same privileges and immunities customarily accorded warships [FCG].

1.5.3. Privileges and immunities include, in the absence of stipulations to the contrary: exemption from duties and taxation; immunity from search, seizure, and inspections (including customs and safety inspections); and, any other exercise of jurisdiction by the HN over the aircraft or the personnel, equipment, or cargo on board [FCG].

**1.6. Flight Operations within the NAS.** [FAA Pilot/Controller Glossary; U.S. AIP] The NAS is the airspace, air navigation facilities, and airfields of the United States. It includes components shared jointly with the military and all associated information, services, rules, regulations, policies, procedures, personnel, and equipment. **Note:** Military aircraft comply with the laws, regulations, and rules which pertain to "aircraft operations." Many regulations and rules address only "civil aircraft operations," which does not include military or other public aircraft. Some civil aviation only rules are implemented by the DoD as a matter of policy to which exceptions apply.

**1.7. Waivers.** Refer to AFI 33-360 for waiver guidance. The Director of Operations, AF/A3O, is the waiver authority for any non-tiered directive guidance in this manual. MAJCOMs (or subordinate units for Tier 2 and Tier 3 waivers) initiate and staff all waiver packages. Coordination through the Air Force Flight Standards Agency Flight Directives Division (AFFSA/XOF), [hqaffsa.xof@us.af.mil](mailto:hqaffsa.xof@us.af.mil), <https://cs2.eis.af.mil/sites/10539/XO/XOF>, is required for Tier 0 and Tier 1 waivers and recommended for Tier 2 and Tier 3 waivers.

1.7.1. AFFSA/XOF will pursue external agency approval for Tier 0 waivers and provide results to the requesting MAJCOM (e.g., an exemption granted by the FAA Administrator).

1.7.1.1. Waivers to utilize a current or renewed external agency exemption must be approved by the MAJCOM Director of Operations (MAJCOM/A3). If a new MAJCOM/A3 is appointed, the waiver must be reapproved by them. MAJCOMs will forward a copy of the AF Form 679 with MAJCOM/A3 approval within 10 days to HQ AFFSA/XOF for tracking purposes. **Note:** HAF/A3O concurrence on AF Form 679 is not required for renewed waivers to existing FAA exemptions.

1.7.1.1. (AFMC) Approved waivers affecting contractors and associated contract(s) become part of the contract and are not subject to reapproval requirements.

1.7.1.2. Current exemptions are available in the AFFSA/XOF SharePoint (<https://cs2.eis.af.mil/sites/10539/XO/XOF/layouts/15/start.aspx#/SitePages/Home.aspx>).

1.7.2. Accomplish all waivers using the AF Form 679. Once approved, wings will send an informational copy to MAJCOM standardization/evaluation and AFFSA/XOF within 5 duty days. (T-1).

1.7.2. (AFMC) Accomplish all Tier 0 and Tier 1 waiver requests using the AF Form 679. Accomplish all Tier 2 and Tier 3 waiver requests on the AFMC Form 73, *AFMC Waiver and Approval Request*. Route Tier 0/1/2 waiver requests through appropriate operations channels to AFMC/A3V using the AFMC/A3V SharePoint <https://cs2.eis.af.mil/sites/12875/default.aspx> for processing. Email approved T-3 waivers to AFMC/A3V workflow. AFMC/A3V will forward informational copy of approved waiver to AFFSA/XOF within 5 duty days. (T-2).

**1.8. Violations.** A violation (pilot deviation) may result when a USAF aircraft deviates from a flight rule. FAA air traffic control (ATC) deviation reports involving USAF aircraft are processed by the Air Force Representative to the FAA (AFREP) in accordance with AFI 13-201, *Airspace Management*. USAF ATC deviation reports involving USAF aircraft are processed in accordance with AFI 91-202, *The US Air Force Mishap Prevention Program*. Violations that occur in the airspace of foreign nations are processed in accordance with the procedures of that nation.

1.8.1. If a unit or pilot is notified by an air traffic controller or AFREP of a possible pilot deviation, the unit or pilot shall preserve any available evidence for a minimum of 180 days and contact the AFREP prior to disposal. (T-1).

1.8.2. For any communications involving any alleged violation, utilize aircraft call-sign only and do not release any aircrew member information to non-USAF agencies without the permission of the AFREP in coordination with the MAJCOM/A3 or AF/A3O. (T-1).

**1.9. Deviations.** [14 CFR Part 91.3] An ATC clearance is not authority to deviate from this manual. In an inflight emergency requiring immediate action, the PIC may deviate from any rule to the extent required to meet that emergency. When deviating from an ATC clearance, notify ATC of the action taken as soon as possible. **Note:** In the event of a deviation from a flight rule or when given traffic priority by ATC in an emergency, the PIC will verbally report the incident to a supervisor or commander and prepare a detailed written record within 24 hours or as soon as mission permits. (T-1).

**1.10. Aviation Safety Reporting.** Potential hazards to aviation safety should be reported via the military aviation safety action program (ASAP) (<https://asap.safety.af.mil>). Personnel will report incidents involving damage to aircraft, personal injury, or intentional disregard of orders or instructions, whether reported to ASAP or not, to a flight safety officer as soon as possible. (T-1). Report hazardous air traffic events in accordance with AFMAN 91-223, *Aviation Safety Investigations and Reports*.

**1.11. Airworthiness.** See AFI 62-601, *USAF Airworthiness*.

## Chapter 2

### ROLES AND RESPONSIBILITIES

#### 2.1. Air Force Flight Standards Agency (AFFSA). AFFSA will:

- 2.1.1. Serve as the OPR for this manual and advise MAJCOMs on all aspects of flight operations.
- 2.1.2. Assist MAJCOMs with identifying and defining communication, navigation and surveillance (CNS) requirements and accomplishing operational approvals.
- 2.1.3. Review MAJCOM operational approvals for consistency with civil standards and for completeness of operational procedures, aircraft flight manuals, and directives prior to staffing for endorsement.
- 2.1.4. Serve as the focal point for all FAA operational exemptions and maintain a registry of current exemptions. Coordinate with AF/A3O prior to submitting an exemption request.

**2.2. Major Command (MAJCOM).** MAJCOMs will provide guidance, where specified throughout this manual. For the purposes of this manual, flying MAJCOMs are: Air Combat Command (ACC), Air Education and Training Command (AETC), Air Force District of Washington (AFDW), Air Force Global Strike Command (AFGSC), Air Force Material Command (AFMC), Air Force Reserve Command (AFRC), Air Force Special Operations Command (AFSOC), Air Mobility Command (AMC), Defense Intelligence Agency (DIA), National Guard Bureau (NGB), Pacific Air Forces (PACAF), and United States Air Forces Europe-Air Forces Africa (USAFE-AFAFRICA). Air Force Commanders in the grade of O-8 or higher in combatant commands are considered MAJCOM commanders only for forces under their operational control. MAJCOMs will:

#### 2.2. (AFMC) Major Command (MAJCOM). AFMC guidance is applicable to DCMA and contractor aircrew.

- 2.2.1. Provide guidance to address aircrew alertness and fatigue management (e.g., use of “go” and “no-go” medications, controlled cockpit rest).
- 2.2.1. (AFMC) Use of go and no-go medication must be approved by a Flight Surgeon. (T-2).
- 2.2.2. Establish alert and compensatory periods in keeping with mission requirements and operational risk management.
- 2.2.2. (AFMC) Alert and compensatory periods may be implemented with FOA approval.
- 2.2.3. Manage assigned Mode S dynamic addresses to ensure no two aircraft are operating with the same address simultaneously.
- 2.2.3. (AFMC) Assigned Mode S dynamic addresses are not applicable to AFMC aircraft.
- 2.2.4. Establish transponder procedures (i.e., mission specific and aircraft specific) for operational use of Mode 3A/C, Mode S, and ADS-B.
- 2.2.4. (AFMC) If equipped, squawk Mode 3A/C, Mode S and ADS-B. Unit Operations Officer may reduce requirements to meet test, operational, or training objectives.



2.2.5. Provide operational guidance for laser eye protection in accordance with AFI 11-301V1, *Aircrew Flight Equipment (AFE) Program* and FAA Advisory Circular (AC) 70-2B, *Reporting of Laser Illumination of Aircraft*.

2.2.5. (AFMC) When LEP is required for test, the test plan must prescribe aircrew requirements and provide operational guidance for use of LEPs.

2.2.6. Coordinate with the MDS system program office (SPO) and program managers when developing and approving use of personal, public, or non-DoD resources (hardware or software) to include carry-on hardware components (e.g., Global Positioning System (GPS) pucks) to be utilized by aircrew (e.g., personally owned devices, non-DoD networks, commercial websites).

2.2.6. (AFMC) Follow MDS lead MAJCOM guidance or comply with test plan.

2.2.7. Provide tactical operations guidance for CNS equipment.

2.2.7. (AFMC) When required, follow MDS lead MAJCOM guidance or comply with test plan.

2.2.8. Provide aircrew training, ensure aircraft certification, and grant operational approval for Area Navigation (RNAV) operations and required navigation performance (RNP) operations.

2.2.8. (AFMC) Follow MDS lead MAJCOM guidance. Refer to AFMC/A3V SharePoint for the current MDS specific CNS/ATM certifications.

2.2.9. Train aircrew, certify aircraft performance-based communication and surveillance (PBCS) systems, and grant operational approval prior to use PBCS.

2.2.9. (AFMC) Follow MDS lead MAJCOM guidance. Refer to AFMC/A3V SharePoint for the current MDS specific CNS/ATM certifications.

2.2.10. Publish procedures to ensure that aircraft do not exceed protected airspace if allowing aircraft to fly an instrument approach using a lower category.

2.2.10. (AFMC) Not applicable to AFMC.

2.2.11. Develop programs to ensure aircrew are trained, aircraft are certified, and grant operational approval for operations within Reduced Vertical Separation Minimum (RVSM) airspace. **Note:** Formation flights are non-RVSM if any aircraft in the formation is non-RVSM.

2.2.11. (AFMC) Follow MDS lead MAJCOM guidance. Refer to AFMC/A3V SharePoint for the current MDS specific CNS/ATM certifications.

2.2.12. Develop procedures that account for declared distances during touch-and-go operations.

2.2.12. (AFMC) See [paragraph 4.46.6](#)

2.2.13. Develop operational guidance on required visual flight rules (VFR) and low-level navigational chart utilization.

2.2.13. (AFMC) Reference AFMAN 11-2FTV3, *Flight Test Operations Procedures*.

2.2.14. Establish acceptable methods for calculating a derived decision altitude (DDA) if aircraft flight manual guidance does not adequately address DDA (e.g., use of demonstrated

altitude lost in a go-around, use of industry practice 50 feet above the minimum descent altitude (MDA) as the DDA).

2.2.14. (AFMC) Aircrew will use 50 feet above MDA for DDA unless flight manual requires/specifies another technique.

2.2.15. Provide aircraft-specific operational approval and training prior to authorizing operations using navigational aids (NAVAIDs) oriented to true or grid north.

2.2.15. (AFMC) Not authorized in AFMC unless required for test. If required, test plan must define aircrew training requirements and provide aircraft-specific operational approval.

2.2.16. Determine the highest allowable latitude for aircraft capable of displaying only magnetic heading for areas north of 70° North and south of 60° South that are not officially designated as areas of magnetic unreliability (AMU).

2.2.16. (AFMC) Not applicable to AFMC unless required for test. If required, publish in test plan.

2.2.17. Where necessary, develop departure procedures for use by specific aircraft and MAJCOM-certified aircrew under specific conditions.

2.2.17. (AFMC) If required for test, publish procedures in test plan.

2.2.18. Where necessary, develop programs that may authorize pilots to use a suitable RNAV system or RNP system to navigate on the final approach segment of a conventional instrument approach procedure based on a Very High Frequency Omni-directional Range (VOR), Tactical Air Navigation (TACAN), or Nondirectional Radio Beacon (NDB).

2.2.18. (AFMC) If required for test, publish procedures in test plan.

2.2.19. Where necessary, at specific airfields, develop their own approach procedures for use by specific aircraft and MAJCOM-certified aircrew under specific conditions.

2.2.20. Provide training and operational approval for special aircrew and aircraft certification required approaches. **Note:** Training and approval for one procedure type does not extend to other procedure types (e.g., operational approval for Category (CAT) II procedures does not also authorize Special Authorization (SA) CAT I procedures).

2.2.20. (AFMC) If required for test, publish procedures and approval in test plan. Associated training plans must be approved by AFMC/A3V prior to use. **(T-2)**.

2.2.21. Where necessary, authorize SA CAT II aircrew to continue CAT II operations if the installed touch down zone or runway centerline lights fail.

2.2.21. (AFMC) Not applicable to AFMC unless required for test. If required, reference test plan.

2.2.22. MAJCOMs will develop aircrew training for use of non-United States Government (USG) products to include commercial publications or host nation products. **Note:** AFFSA maintains a current list of accepted host nation products and publications.

2.2.22. (AFMC) If required, complete appropriate training plan and document in aircrew training folder.

2.2.23. In coordination with MDS SPO, provide operating guidance, procedures, and training prior to authorizing electronic flight bag (EFB) usage. **Note:** MDS SPO approval is required if connecting to aircraft power. AFFSA will assist lead MAJCOM with the development and implementation of EFB programs. MAJCOMs should reference FAA AC 120-76, *Authorization for Use of Electronic Flight Bags* when developing programs.

2.2.23. (AFMC) Follow MDS lead MAJCOM guidance.

2.2.24. Conduct large-scale exercises in permanent or temporary special use airspace established according to FAA JO 7400.2, *Procedures for Handling Airspace Matters*, and FAA JO 7610.4, *Special Operations*. When MAJCOMs approve large-scale exercises or short-term special missions they will ensure information on approved activities is available to the non-participating flying public and coordinate these operations with:

2.2.24.1. Affected non-participating military flying units;

2.2.24.2. Affected FAA Air Route Traffic Control Center;

2.2.24.3. Affected FAA regions through the AFREP; and

2.2.24.4. Other agencies, as appropriate.

2.2.25. CNS Operational Approvals. MAJCOM/A3 approves operational use of CNS and navigation safety systems. Coordinate with AFFSA/XON for capabilities that require operational approval and AF/A3O endorsement. Contact AFFSA/XON at ([hqaffsa.xon@us.af.mil](mailto:hqaffsa.xon@us.af.mil)).

2.2.25.1. Provide aircrew training and certification, instructions, procedures, and minimum equipment lists for CNS capabilities to aircrew and maintenance personnel. **Note:** At MAJCOM/A3's discretion, MAJCOMs may utilize the lead command's endorsements for similar platforms (e.g., USAFE-AFAFRICA or AFRC may use AMC C-40 RNP Authorization Required (AR) operational approval). If training, instructions, procedures, or minimum equipment lists differ from the lead command, a separate operational approval is required.

2.2.25.1. (AFMC) AFMC accepts CNS/ATM Lead MAJCOM certifications and approvals. Refer to AFMC/A3V SharePoint for the current MDS specific CNS/ATM certifications, approvals, and training requirements. If training is mandated, crews shall not use CNS equipment until specified training has been certified complete.

2.2.25.2. Reference AFI 63-137, *Assurance of Communications, Surveillance/Air Traffic Management (CNS/ATM), Navigation Safety, and Next Generation Air Transportation System (NextGen) Performance* and AFI 63-112, *Cockpit Working Groups*.

2.2.26. Any primary flight reference (PFR) used for instrument flight will be endorsed by AF/A3O. Contact AFFSA/XON ([hqaffsa.xon@us.af.mil](mailto:hqaffsa.xon@us.af.mil)) for endorsement process. **Note:** Lead command will define display requirements for aircraft not certified or authorized for instrument flight.

2.2.26.1. USAF aircraft cockpits and UAS control stations must always be capable of providing full-time attitude, altitude, airspeed information, and the capability to recognize, confirm, and recover from unusual attitudes in all pilot positions.

2.2.26.2. UAS control stations must display full time link status, link availability, lost link indications, and logic information (autopilot control mode, primary route, and contingency route). **Exception:** Contingency route may be immediately available if not displayed at all times.

2.2.26.3. MAJCOMs will issue guidance for configuration of pilot-selectable flight displays. In actual instrument meteorological conditions (IMC) or when there is no discernible horizon, an AF/A3O-endorsed PFR shall be displayed in the pilot flying position.

2.2.26.3. (AFMC) Follow MDS lead MAJCOM guidance or Flight Operations Authority (FOA) approved configuration profiles.

### 2.2.27. Foreign Terminal Instrument Procedure (FTIP).

2.2.27.1. Design Criteria Review. MAJCOM TERPS offices validate the safety of the host nation instrument procedures by comparing the design against approved criteria (US TERP, ICAO PANS-OPS, or NATO MIPS). The TERPS function then identify nonstandard conditions that require mitigation.

2.2.27.2. MAJCOM Operational Risk Management Assessment. Establish operational risk management assessment procedures for MAJCOM approval of FTIP reviews.

2.2.27.3. Flyability Check. Establish procedures for obtaining Foreign Terminal Instrument Procedure (FTIP) flyability checks when required. FTIP flyability checks are another means for MAJCOM instrument procedure specialists to ensure FTIP are safe, practical, and consistent with good procedure design prior to publication in DoD FLIP. Usually, a flyability check is the single incomplete requirement preventing MAJCOM procedure specialists from submitting FTIP to the National Geospatial-Intelligence Agency (NGA) for inclusion in DoD-published FLIP.

**2.3. Pilot in Command (PIC).** The PIC is the aircrew member designated by competent authority, regardless of rank, as being responsible for, and is the final authority for the operation of the aircraft [14 CFR Part 91.3, AFI 11-401, *Aviation Management*]. **(T-0).** PIC will ensure the aircraft is not operated in a careless, reckless, or irresponsible manner that could endanger life or property. [14 CFR Part 91.13] **(T-0).**

2.3.1. The PIC should not accept an aircraft for flight if they suspect the aircraft is not airworthy. (e.g., an aircraft that is involved in an incident that results in damage to the aircraft.).

2.3.2. The PIC will ensure compliance with this AFMAN and the following: HAF, MAJCOM, and MDS-specific manuals, FLIP and FCG, ATC clearances, Notices to Airmen (NOTAMs), aircraft T.O., and Combatant Commander's instructions including other associated directives. **(T-1).**

2.3.2. (AFMC) AFMC/A3V is the OPR for the three-volume set of Flight Test (FT) publications containing attachments for each MDS flown in AFMC. These publications are: AFMAN 11-2FTV1, *Flight Test Aircrew Training*; AFMAN 11-2FTV2, *Flight Test Aircrew Evaluation Criteria*; and AFMAN 11-2FTV3. AFMC uses these publications in lieu of AFMAN/AFI 11-2 MDS-specific volumes for flying operations. In the absence of published guidance, AFMC units may use lead MAJCOM guidance or coordinate with HQ AFMC/A3V for approval of locally developed guidance. **(T-2).**

2.3.3. **(Added-AFMC)** AFMC flying unit supplements to AFMAN 11-202V3 are not authorized. Units may incorporate required operational procedures into the AFMAN 11-2FT series as applicable and obtain AFMC/A3V review and approval of AFMAN 11-2FT series unit supplements prior to publication. **(T-2)**.

**2.4. Aircrew.** Individuals designated on the flight authorization responsible to fulfill specific aeronautical tasks regarding operating USAF aircraft.

2.4.1. Follow AFI 11-403, *Aerospace Physiological Training Program*, guidance for flight restrictions following an altitude (hypobaric) chamber flight. **Exception:** There are no flight restrictions following reduced oxygen breathing device (ROBD) training or to conduct UAS flight operations.

2.4.2. Aircrew will not fly or assume aircraft control for UAS:

2.4.2.1. When appropriate crew rest was not obtained in accordance with [paragraph 3.1 \(T-3\)](#).

2.4.2.2. If any alcohol was consumed within 12 hours prior to takeoff or if impaired by alcohol or any other intoxicating substance, to include the effects or after-effects. **(T-1)**.

2.4.2.3. Anytime a physical or psychological condition is suspected or known to be detrimental to the safe performance of flight duty. **(T-1)**.

2.4.2.4. While self-medicating unless cleared in accordance with [paragraph 3.7.2](#)

2.4.2.5. Within 72 hours after donating blood, plasma, or bone marrow. **(T-1)**.

2.4.2.6. Within 24 hours of compressed gas diving including SCUBA, surface supplied diving, aircraft pressurization checks exceeding 10 minutes in duration below sea level or hyperbaric (compression) chamber exposure. **(T-1)**. **Note:** Not applicable (N/A) for UAS. **Exceptions:**

2.4.2.6.1. Following helicopter emergency egress device system (HEEDS) training, aircrew may only fly if the aircraft's maximum altitude remains below 10,000 feet mean sea level (MSL). **(T-1)**.

2.4.2.6.2. Air Force divers on aeronautical orders will follow guidelines in accordance with SS521-AG-PRO-010, U.S. Navy Diving Manual for flying and diving restrictions. **(T-1)**.

2.4.2.7. **(Added-AFMC)** Any assigned, attached, or temporary duty aircrew member involved in a Class A or B mishap shall be administratively grounded by the FOA immediately following the mishap. **(T-2)**. Any aircrew member involved in a Class A mishap will not perform aircrew duties in AFMC assigned aircraft until authorized in writing by the flying unit's wing commander or AFMC/A3V for units without a rated wing commander. **(T-2)**. Any aircrew member involved in a Class B mishap will not perform aircrew duties in AFMC assigned aircraft until re-authorized by the FOA. **(T-3)**. Safety privileged mishap data will not be used to administratively ground aircrew member. Copies of all relative actions will be maintained in section V of affected individual's training folder. **(T-2)**.

## Chapter 3

### GENERAL FLIGHT RULES

**3.1. Crew Rest.** Commanders and supervisors will ensure aircrew are provided a 12-hour rest opportunity prior to beginning the flight duty period. **(T-3).** Crew rest is free time and includes time for meals, transportation, and an opportunity for at least 8 hours of uninterrupted sleep. Crew rest cannot begin until after the completion of official duties. Crew rest is compulsory for aircrew members prior to performing any duties involving aircraft operations and is a minimum of 12 non-duty hours before the flight duty period (FDP) begins.

3.1.1. Aircrew members must inform the PIC or mission execution authority if not sufficiently rested for flight duties. **(T-3).**

3.1.2. If crew rest is interrupted, individuals will immediately inform the PIC or mission execution authority and will either begin a new crew rest period or not perform flight duties. **(T-1).** An interruption is any official business conducted after crew rest. **Exception:** PIC (or designee) may initiate mission-related communication with official agencies without interrupting crew rest.

3.1.3. The authority waiving the 12-hour crew rest period must ensure that the PIC is notified prior to beginning crew rest. **(T-2).** The PIC is not required to accept reduced crew rest, even if waiver has been granted by the appropriate waiver authority.

3.1.4. When three or more consecutive flight duty periods of at least 12 hours duration are scheduled, crew rest may be reduced by the PIC to a minimum of 10 hours in order to maintain a 24-hour work/rest schedule. The 10-hour crew rest authorization is only used to keep crews in 24-hour clock cycles, not for scheduling convenience or additional sortie generation.

3.1.5. Any reduction from 12-hour crew rest requires pre-coordination for transportation, meals, and quarters so that aircrew members are provided an opportunity for at least 8 hours of uninterrupted sleep.

3.1.6. **(Added-AFMC)** Time spent traveling (e.g., as a passenger or in a POV) to or from a TDY location does not count as crew rest for the subsequent Flight Duty Period (FDP). **(T-2).**

3.1.7. **(Added-AFMC)** USAF Test Pilot School (TPS) students will not be scheduled for events that would deny them 12 hours of crew rest. However, students may elect to use school facilities (i.e., computers, data reduction equipment and audio-visual equipment) so long as it does not interfere with the opportunity for at least 8 hours of uninterrupted rest during the 12 hours immediately prior to the beginning of the flight duty period. To ensure this happens, students will depart the USAF TPS no later than 1 hour before the 8 hour window for uninterrupted rest begins. **(T-2).** This provision does not apply to lengthening the FDP.

**3.2. Flight Duty Period (FDP).** Mission execution authority shall schedule FDPs in accordance with **Table 3.1 (T-3).**

3.2.1. The FDP begins when an aircrew member first reports for official duty and ends at final engine shutdown after the final flight of the completed mission. FDP for UAS aircrew member ends at final engine shutdown, final in-flight handover briefing, or final crew swap, whichever occurs last.

3.2.2. The PIC is authorized to extend FDP a maximum of 2 hours to compensate for unplanned mission delays.

3.2.2. (AFMC) Supervisors at all levels may restrict crew duty day to help mitigate elevated risk factors associated with fatigue, weather, or complex test elements.

3.2.3. If official post-flight duties are anticipated to exceed 2 hours, consider reducing the FDP to ensure safe completion of those duties.

3.2.4. (Added-AFMC) FCF/ACF, proficiency training, test or test support sorties, and tactical events must be completed during the first 12 hours of the FDP. Fighter/trainer aircraft are limited to a maximum of three sorties per day. (T-3). FCF/ACF missions flown to establish airworthiness (O-8E mission symbol) will be rescheduled if unexpected delays prevent completion of all required inspection items within the normal flight duty period. (T-3).

**Table 3.1. Maximum FDP.**

| Aircraft Type  | Basic Crew (Hours) | Augmented Crew (Hours) |
|--|--------------------|------------------------|
| Single Piloted Aircraft  | 12                 | N/A                    |
| Fighter, Attack or Trainer (Dual Control)  | 12                 | 16                     |
| Bomber, Reconnaissance, Electronic Warfare, or Battle Management (Dual Control)  | 16                 | 24                     |
| Tanker / Transport   | 16                 | 18                     |
| Tanker / Transport with Sleeping Provisions (*)  | 16                 | 24                     |
| Rotary Wing (without Auto Flight Control System)   | 12                 | 14                     |
| Rotary Wing (with Auto Flight Control System)  | 14                 | 18                     |
| Utility  | 12                 | 18                     |
| Unmanned Aircraft System (Single Control)  | 12                 | N/A                    |
| Unmanned Aircraft System (Dual Control)  | 16                 | N/A                    |
| Tilt-rotor   | 16                 | N/A                    |
| *Note: Sleeping provisions are crew bunks or other MAJCOM-defined rest facilities aboard the aircraft. Rest facilities should provide adequate privacy and noise levels to obtain suitable rest. |                    |                        |

**3.3. Deadhead Time.** Deadhead time is an official duty performed by an aircrew member flying as a passenger (no flight-related duties performed) while on flight orders and may be flown without crew rest.

3.3.1. If flight-related duties are planned to be performed following deadheading, crew rest and FDP restrictions apply.

3.3.2. If in-flight or crew-specialty related duties (e.g., aircraft off-loading or performance data calculations) are performed in conjunction with deadheading, crew rest and FDP restrictions apply.

3.3.3. Deadhead aircrew will be annotated as mission essential personnel on the Flight Authorization in accordance with AFI 11-401, *Aviation Management*. (T-1).

**3.4. Maximum Flying Time.** Maximum flying time is 56 flight hours per 7 consecutive days, 125 flight hours per 30 consecutive days, and 330 flight hours per 90 consecutive days. **(T-2).** **Note:** Maximum flying time may be waived by MAJCOM/A3 when an operational risk management assessment determines that mission requirements justify the increased risk. MAJCOM/A3 may delegate the waiver authority no lower than squadron commander.

**3.5. Controlled Cockpit Rest.** As authorized by the MAJCOMs and only during non-critical phases of flight. **Note:** Cockpit rest does not reset required crew rest.

**3.6. Aircrew Flight Equipment.** Aircrew will wear and use authorized clothing and equipment in accordance with applicable AFIs, AFMANs, MAJCOM or wing guidance, special instructions (SPINS) and aircraft flight manual. **(T-1).**

3.6.1. Aircrew must undergo a MAJCOM-approved initial certification course prior to their initial flight with Night Vision Devices (NVDs). **(T-1).** Certification is in accordance with AFI 11-202V1, *Aircrew Training*.

3.6.1. **(AFMC)** Operations and training requirements for NVD are specified in AFMAN 11-2FTV1 and AFMAN 11-2FTV3.

3.6.2. Aircrew must have an operable flashlight for night operations. **(T-3).** **Note:** N/A for UAS.

**3.7. Aircrew Medical Standards.** Aircrew must maintain a medical clearance in accordance with AFI 48-123, *Medical Examinations and Standards*.

3.7.1. Corrective lenses are authorized in accordance with AFI 48-123. Aircrew who require corrective spectacles will carry a backup set of clear MAJCOM-approved corrective lenses while performing aircrew duties. **(T-1).** **Exception:** USAFA glider pilots only require one set of corrective lenses.

3.7.2. Medical or dental treatment obtained from any source must be cleared by flight medicine prior to reporting for flight duty. **(T-1).**

3.7.2.1. Use of any medication (prescription or over-the-counter), herbal, nutritional, and dietary supplements is governed by AFI 48-123 and as approved by flight medicine.

3.7.2.2. Oxymetazoline or phenylephrine nasal sprays may be carried should unexpected ear or sinus block occur during flight. **Note:** Not for treatment of symptoms prior to flight. If used, the member is considered duties not including flying (DNIF) until cleared by flight medicine.

**3.8. Nonrated Flyers.** Flying unit commanders must ensure nonrated personnel and civilians who perform in-flight duties receive an indoctrination course on MDS-specific missions, egress, emergency procedures, and use of flight and emergency equipment. **(T-1).** A preflight briefing does not qualify as an indoctrination course.

**3.9. Flight Demonstrations and Aerial Events.** Do not conduct unauthorized or impromptu flight demonstrations, maneuvers, or flyovers. **(T-1).** Comply with AFI 11-209, *Participation in Aerial Events*.

**3.10. Transporting Passengers Under the Influence.** Ensure passengers suspected to be under the influence of intoxicants or narcotics are not allowed to board a USAF aircraft except in an emergency or when authorized by command and control authority. **(T-2).**



**3.11. Tobacco Use.** Tobacco use in all forms, including electronic nicotine delivery systems, is prohibited on all aircraft. **(T-1). Exception:** Nicotine patches.

**3.12. Transport of Drugs.** Aircrew will not allow the transport of narcotics, controlled substances, or other dangerous drugs unless such transport has been approved by a U.S. Military, Federal, or State authority. **(T-1).**

**3.13. Hazardous Cargo.** Comply with Air Force Joint Instruction (AFJI) 11-204, *Operational Procedures For Aircraft Carrying Hazardous Materials*.

**3.14. Flight Displays.** Comply with MAJCOM or MDS-specific guidance for configuration of pilot-selectable flight displays. **(T-2).**

**3.14. (AFMC) Flight Displays.** AFMC aircrew will follow guidance in the AFMAN 11-2FTV3. If MDS specific guidance is not published in AFMAN 11-2FTV3, refer to lead MAJCOM guidance. **(T-2).**

**3.15. Authorized Resources for Flight and Mission-Related Duties.** Do not conduct flight and mission-related duties with devices and resources (e.g., personally owned devices, non-DoD networks, commercial websites) that have not been approved by the MAJCOM. **(T-2).**

**3.15. (AFMC) Authorized Resources for Flight and Mission-Related Duties.** Aircrew members will attempt to use official Air Force websites as a first choice followed by US Government provided websites using government issued/owned devices. **(T-2).** If unavailable, aircrews may use commercial planning websites/devices but assume full responsibility for data verification.

**3.16. Portable Electronic Devices (PEDs).** The PIC will prohibit the use of any PED suspected of creating interference with systems on the aircraft. **(T-1).** MAJCOMs will authorize PEDs used to facilitate mission execution (e.g., electronic flight bags, portable GPS units).

**3.16. (AFMC) Portable Electronic Devices (PEDs).** PED operations are in accordance with lead MAJCOM policy, FOA approved local guidance, or test plan guidance.

3.16.1. The following non-transmitting PEDs may be used at any time or altitude: portable voice recorders, hearing aids, heart pacemakers, electric shavers, calculators, watches, or any other portable electronic device authorized by the MAJCOM. **Note:** Apple Watches or other transmitting watches must be operated in airplane mode. **(T-1).**

3.16.2. MAJCOM/A3 may authorize use of transmitting PEDs at any altitude with transmitters ON or OFF. In the absence of MAJCOM guidance, the PIC may authorize use of PEDs at or above 10,000 feet MSL with transmitter OFF (e.g., airplane mode).

3.16.2. **(AFMC)** FOA may approve transmitting PED operations at any altitude. PIC may approve “airplane mode” operations above 10,000 feet MSL.

3.16.3. Pilot use of handheld photo or video recording devices is prohibited when that pilot is the only one with immediate access to the flight controls. **(T-3).**

3.16.4. Normally, only medical equipment referenced in the aircraft flight manual, MDS-specific manual, or listed in the Air Force Medical Logistics website is permitted. See <https://medlog.us.af.mil/>

3.16.5. Personnel will turn off the cellular function of devices while airborne [Title 47 CFR Part 22.925, Prohibition on Airborne Operation of Cellular Telephones]. **(T-0)**. It is also USAF policy to keep cellular devices off when airborne above a foreign territory. **Note:** This restriction exists to prevent potential disruption of the cellular ground network. It is unrelated to aircraft operations.

3.16.6. **(Added-AFMC)** AFMC authorizes connection of PEDs to aircraft power. Connection of PEDs to data or antennae requires written approval from the Program Office.

3.16.7. **(Added-AFMC)** PEDs will not be used as the sole means of navigation nor interfere with accomplishment of normal in-flight duties.

3.16.8. **(Added-AFMC)** Personally owned devices and/or software are not authorized for in-flight duties. **(T-2)**. Additionally, personally owned devices may not be used while performing primary aircrew duties. Tanker/transport aircraft follow Lead MAJCOM guidance regarding personal use of personally owned devices in flight. **(T-3)**.

3.16.9. **(Added-AFMC)** The use of a hand-held camera in single-seat aircraft is prohibited but an aircraft or helmet-mounted camera(s) may be used provided the pilot does not manipulate camera controls during critical phases of flight. **(T-2)**.

3.16.10. **(Added-AFMC)** Cameras are authorized in multiple-seat aircraft provided the camera operator is not actively controlling the aircraft and has PIC approval prior to filming.

3.16.11. **(Added-AFMC)** Only aerial photography personnel (AFSC 3VXXX) may perform photographer duties for test missions requiring photo-data collection. **(T-3)**.

### **3.17. Electronic Flight Bags (EFBs) [FAA AC 120-76].**

3.17.1. EFBs cannot replace any installed equipment that is part of the baseline configuration of the aircraft and will not be used as a PFR. **(T-1)**.

3.17.2. When in use, portable EFBs must be secured and viewable during critical phases of flight and must not interfere with flight control movement, emergency egress, or oxygen deployment. **(T-1)**. **Exception:** Aircrew may remove EFB from its securing device and hold by hand during critical phases of flight when operationally necessary (e.g., briefing an approach).

3.17.3. Data downloaded during flight is secondary to the primary navigation displays and onboard weather radar (if equipped). Aircrew will not rely exclusively on weather data downloaded in flight to maneuver the aircraft. **(T-2)**.

**3.18. Aircraft Movement on the Ground.** Comply with AFMAN 11-218, *Aircraft Operations and Movement on the Ground*, MAJCOM, and locally published procedures. Aircrew will obtain clearance from ATC before taxiing, proceeding onto a runway, takeoff or landing at an airport with an operating control tower. **(T-0)**. Aircrew will read back all taxi and hold short instructions. **(T-0)**. If a taxi route requires crossing any runway, pilots will hold short until obtaining specific clearance to cross each runway [14 CFR Part 91.123]. **(T-0)**.

**3.19. Crew at Stations.** Aircrew must occupy their assigned duty stations from takeoff to landing unless absence is necessary to perform duties in connection with the operation of the aircraft or physiological needs [14 CFR Part 91.105]. **(T-0)**. **Note:** For the purposes of this paragraph only, aircrew is to mean the pilots, flight navigators, and engineers.

**3.20. Inflight Reporting.** See also AFMAN 10-206, *Operational Reporting (OPREP)*.

3.20.1. Aircrew will immediately report hazardous weather conditions, wake turbulence, volcanic activity, large concentrations of birds or wildlife on or near the airfield, or any other significant flight condition that may affect aviation safety to the appropriate controlling agency. **(T-2)**. **Note:** See the *Flight Information Handbook (FIH)* for pilot report format.

3.20.2. Declare “minimum fuel” or “emergency fuel” to the appropriate controlling agency when the aircraft may land at the intended destination with less than the MDS-specific minimum reserve or emergency fuel [AIM 5-5-15].

3.20.3. Aircrew will report position as requested by ATC, host-nation procedures, or ICAO procedures. **(T-0)**. See the *IFR - Supplement* for position report format.

3.20.4. Aircrew will report encountering a laser illumination event to ATC or applicable command and control entity. **(T-1)**.

3.20.5. Report any electromagnetic interference in accordance with joint spectrum interference resolution procedures in the FIH and AFI 17-221, *Spectrum Interference Resolution Program*.

**3.21. Oxygen and Pressurization Requirements (N/A for UAS).** Ensure sufficient oxygen for the planned mission is available to all occupants before takeoff. **(T-0)**. Pilots flying pressurized operations will maintain a cabin altitude below 10,000 feet and must comply with the supplemental oxygen requirements in **Table 3.2 (T-1)**. Aircrew will use supplemental oxygen any time the cabin pressure altitude exceeds 10,000 feet MSL except as outlined in **paragraph 3.21.1. (T-1)**. When mission essential, aircrew trained in accordance with AFI 11-403, *Aerospace Physiological Training Program*, may operate aircraft unpressurized up to Flight Level (FL) 250 in accordance with MAJCOM guidance and the following restrictions:

3.21.1. Without supplemental oxygen aircrew will:

3.21.1.1. Not operate above 14,000 feet MSL. **(T-2)**.

3.21.1.2. Not exceed 1 hour between 10,000 MSL and 12,500 feet MSL if any portion of the flight is conducted in IMC, at night, while employing weapons, conducting airdrop, air-refueling, or if performing high-g maneuvers. **(T-2)**.

3.21.1.3. Not exceed 30 minutes between 12,500 MSL and 14,000 feet MSL. **(T-2)**.

3.21.2. If any passenger is not trained in accordance with AFI 11-403 the following restrictions apply:

3.21.2.1. Do not exceed 13,000 feet. **(T-2)**.

3.21.2.2. Do not exceed 3 hours above 10,000 feet. **(T-2)**.

3.21.3. Supplemental oxygen will be used by all occupants between 14,000 feet MSL and FL250. **(T-2)**. All occupants will wear functional pressure suits above FL250 (See **paragraph 3.21.8**). **(T-1)**. **Exception:** AFSOC aircraft and special operations C-17 aircrews conducting MAJCOM/A3 approved high altitude airdrop missions (above FL250).

**Table 3.2. Oxygen Requirements for Pressurized Aircraft According to Aircraft Altitude.**

|   | Pilot(s) <sup>1</sup>      | Cockpit Crew <sup>2</sup> | Other Flight Deck Crew | Cabin / Cargo Area Crew | Pax |
|---|----------------------------|---------------------------|------------------------|-------------------------|-----|
| 10,000 feet to FL 250                               | R                          | R                         | R                      | A                       | N/A |
| Above FL 250 to FL 350                              | One I / One R              | R                         | R                      | A                       | A   |
| Above FL 350 to FL 410<br>(two pilots at controls ) | I                          | R                         | R                      | A                       | A   |
| Above FL 350 to FL 410<br>(one pilot at controls)   | I                          | I                         | R                      | A                       | A   |
| Above FL 410 to FL 450                              | One O / One I <sup>3</sup> | I                         | R                      | A                       | A   |
| Above FL 450 to FL 500                              | One O / One I <sup>3</sup> | I                         | I                      | A                       | A   |
| Above FL 500 to FL 600                              | G                          | G                         | G                      | G                       | G   |
| Above FL 500 (Sustained)                            | S                          | S                         | S                      | S                       | S   |

**Note 1:** Single-pilot aircraft must follow the most restrictive guidance in this table.

**Note 2:** Cockpit crew is defined as those crew positions with access to flight controls or responsibility for flight engineer panel, communication, or navigation systems.

**Note 3:** Replace "One O / One I" with "I" for aircraft with Automatic Emergency Descent Mode operated in accordance with MAJCOM guidance.

**LEGEND**

**A – Oxygen available.** Carry or place portable oxygen units or extra oxygen outlets with masks throughout the cabin/cargo area so that any person has quick access to oxygen should a loss of pressurization occur.

**R – Oxygen readily available.** A functioning system and mask shall be located within arm's reach, and the regulator must be set to 100 percent and ON (when regulator is adjustable).

**I – Oxygen immediately available.** Must wear helmets with an oxygen mask attached to one side, or have an available, approved quick-don style mask properly adjusted and positioned. Set regulators to 100 percent and ON.

**O – Oxygen mask ON.** Regulator ON and normal.

**G – Wear a partial pressure suit.** Suit must provide 70mm Hg of assisted positive pressure breathing for altitude (pressure breathing for altitude system/get-me-down scenario).

**S – Wear a pressure suit.** Suit must provide a total pressure (atmospheric plus suit differential) of at least 141 mm Hg to the head and neck with adequate body coverage to prevent edema and embolism.

3.21.4. For Loss of Cabin Pressure pilots should initiate an immediate descent to the lowest practical altitude, preferably below 18,000 feet MSL. Do not allow cabin altitude to remain above FL250 unless occupants are wearing functional pressure suits. If any occupant lacks functioning oxygen equipment, descend to an altitude of 13,000 feet MSL or less (terrain or fuel requirements permitting) and comply with [paragraph 3.22.1](#).

3.21.5. If cabin altitude exceeds 18,000 feet MSL following the unintended loss of cabin pressure, aircrew and passengers must be evaluated by a flight surgeon or other aviation medical authority prior to further flight. **(T-2)**. If cabin altitude cannot be determined, use the aircraft altitude at the time of the event. Report a loss of cabin pressurization in accordance with AFMAN 91-223.

3.21.6. If any occupant exhibits decompression sickness symptoms, descend as soon as practical and land at the nearest suitable installation where medical assistance can be obtained. Individuals suspected of decompression sickness shall be administered and remain on 100% oxygen (using tight-fitting mask or equivalent) until evaluated by an aviation medical authority. Decompression sickness may occur up to 12 hours after landing. Aircrew will not fly after a decompression sickness event without specific authorization from a flight surgeon. **(T-1).**

3.21.7. If anyone on the aircraft experiences hypoxia symptoms, descend immediately to the lowest practical altitude and land at a suitable location to obtain medical assistance. Aircrew will not fly after a hypoxia event without specific authorization from a flight surgeon. **(T-1).**

3.21.8. Without functional pressure suits, maintain a cabin altitude below FL250 and adhere to the time limits in **Table 3.3** (N/A for U2 operations). **(T-2). Exception:** AFSOC aircraft and special operations C-17 aircrews conducting MAJCOM/A3 approved high altitude airdrop missions (above FL250). For high altitude airdrop missions, use the oxygen requirements in AFI 11-409, *High Altitude Airdrop Mission Support Procedures*. If the aircraft lands between missions and the time on the ground equals or exceeds the time spent at or above a cabin altitude of FL210, the time of allowable duration can be reset to the maximum.

**Table 3.3. Cabin Altitude Time Limits (Decompression Sickness Prevention).**

| Time (minutes) | Cabin Altitude (feet MSL) |
|----------------|---------------------------|
| 0              | At or Above FL 250        |
| 45             | 24,000 – 24,999           |
| 70             | 23,000 – 23,999           |
| 120            | 22,000 – 22,999           |
| 200            | 21,000 – 21,999           |

**3.22. Aircraft Lighting.** [14 CFR Part 91.209] Aircrew will operate aircraft lighting according to the following guidance or host-nation rules and theater SPINS **(T-1)**:

3.22.1. Turn on position lights between sunset and sunrise, when starting or running an engine, while being towed, or when parked in an area likely to create a hazard unless clearly illuminated by an outside source. **(T-0). Exception:** Aircraft that do not have power available before start shall turn them on as soon as power is available. MAJCOMs will establish required procedures and lighting for towing unpowered aircraft between sunset and sunrise.

3.22.1. **(AFMC)** When required, procedures and lighting for towing unpowered aircraft on the ground between sunset and sunrise will be IAW AFMAN 11-218, *Aircraft Operations and Movement on the Ground*. **(T-2).**

3.22.2. Turn on anti-collision or strobe lights prior to engine start and do not turn them off until after engine shutdown. **(T-0). Exception:** Aircraft that do not have power available before engine start shall turn anti-collision or strobe lights on as soon as power is available. **(T-2).** **Note:** Flashing lights may be turned off or reduced in intensity if they adversely affect the performance of duties or subject an outside observer to harmful dazzle.

3.22.3. Turn on landing lights after takeoff clearance is received and the aircraft is on the active runway (across the hold line), when commencing takeoff roll at an airport without an operating control tower, or when operating below 10,000 feet MSL and turn off after exiting the active runway. **(T-3). Exception:** PIC may turn off the landing lights whenever safety or mission requirements dictate.

3.22.4. MAJCOMs may authorize reduced or lights-out operations in restricted areas, warning areas, host-nation approved areas, or designated airfields. Designated airfields shall be documented in a letter of agreement. **(T-1).**

3.22.4. **(AFMC)** Reduced or light-out operations within restricted and warning areas are approved for AFMC aircraft when operational or test requirements dictate. FOA will establish policies for operational requirements in the unit supplement to AFMAN 11-2FTV3, *Flight Test Operations Procedures*.

3.22.5. MAJCOMs may authorize varying aircraft lighting procedures for formation flights provided the light configuration provides an equivalent level of visual identification as a single aircraft.

3.22.5. **(AFMC)** When operating outside restricted or warning areas and in standard formation, one aircraft in the formation will display required lighting. **(T-2).** Others may operate with reduced lighting as safety, operational and test conditions permit.

**3.23. Airfield Lighting.** PICs will not conduct operations from a runway unless it is outlined with operable lighting or high-intensity runway reflective markers, unless authorized by the MAJCOM through the MDS-specific Volume 3 or other specific guidance. **(T-2). Note:** N/A for helicopters

3.23.1. Covert infrared runway lighting used by qualified aircrew equipped with NVDs meets the intent of lighted landing surface.

3.23.2. PICs are restricted to military airfields or civilian airports with an appropriate letter of agreement during non-contingency operations from unlighted runways, landing zones, or runways with high-intensity runway reflective markers. **(T-2). Note:** N/A for helicopters.

3.23.3. In Alaska, areas located north of 60° North latitude, Antarctica, and areas located south of 60° South latitude, aircraft may be operated to unlighted airports during the period of civil twilight.

3.23.4. **(Added-AFMC)** UAS with autonomous takeoff and landing capability are authorized to depart and land at FOA approved runways without the use of runway lighting aids. FOA should publish additional mitigation procedures (runway sweeps, chase vehicle procedures, NOTAM publishing, sensors required) for unlighted runway operations.

**3.24. Right-of-Way.** PIC will take action necessary to avoid collision, regardless of who has the right-of-way. **(T-0).** The yielding aircraft will not pass over, under, abeam, or ahead of the other aircraft unless well clear. **(T-0).** [14 CFR Part 91.113].

3.24.1. Aircraft in distress have the right-of-way over all other air traffic. **(T-0).**

3.24.2. When aircraft of the same category are converging at approximately the same altitude (except head-on or approximately so), the aircraft to the other's right has the right-of-way. **(T-0).** Aircraft of different categories have the right-of-way in the following order of priority:

balloons, gliders, aircraft towing or refueling other aircraft, airships, rotary- or fixed-wing aircraft. **(T-0)**.

3.24.3. If aircraft are approaching each other head-on or approximately so, each shall alter course to the right. **(T-0)**.

3.24.4. An overtaken aircraft has the right-of-way. The overtaking aircraft must alter course to the right. **(T-0)**.

3.24.5. An aircraft established on final approach has the right-of-way over other aircraft on the ground or in the air, except when two or more aircraft are approaching to land. In this case, the aircraft at the lower altitude has the right-of-way but it shall not use this advantage to cut in front of or overtake the other. **(T-0)**.

**3.25. See and Avoid.** [14 CFR Part 91.113] When weather conditions permit, regardless of whether an operation is conducted under IFR or VFR, vigilance shall be maintained by each pilot operating an aircraft so as to see and avoid other aircraft. **(T-0)**. **Note:** UAS without approved sense and avoid capabilities will, when in territorial airspace, be operated under specific arrangements with appropriate aviation authorities (e.g., DoD-FAA agreement, host nation clearance). ). [DoDI 4540.01] In international airspace, all aircraft will utilize approved means of fulfilling the obligation to exercise due regard for other users. **(T-0)**.

**3.26. Adherence to ATC Clearances and Instructions.** [14 CFR Part 91.123; AIM 4-4-10; ICAO Doc 4444, Chapter 4.5; ICAO Annex 11] Include aircraft identification (call sign) in all read backs. Read back ATC clearances and instructions containing altitude assignments, restrictions, vectors, headings, altimeter settings, and runway assignments in the same sequence they are given. Initial read back of a taxi, departure, or landing clearance should include the runway assignment including left, right, or center as applicable. Reading back clearances reduces communication errors that occur when a number is either misheard or incorrect. If the ATC clearance or instructions are unclear, query the controller. **Note:** If unable to meet an ATC altitude restriction, climb or descent, notify ATC.

**3.27. Descent Gradients.** Descent gradients in excess of 10 degrees (1,000 feet per nautical mile) in IMC may induce spatial disorientation when descending “at pilot’s discretion.” Exceeding a 10-degree descent gradient below 15,000 feet AGL substantially decreases margin for error in avoiding obstacles and terrain, and may not provide effective radar monitoring.

### **3.28. Airspeed Adjustments.**

3.28.1. [AIM 4-4-12] ATC issues speed adjustments to pilots of radar-controlled aircraft to achieve or maintain required or desired spacing. Speed adjustments are indicated airspeed expressed in 10 knot increments; speeds may be Mach numbers expressed in 0.01 increments at or above FL 240. Pilots complying with speed adjustments must maintain a speed within +/- 10 knots (0.02 Mach) of the specified speed. **(T-0)**.

3.28.2. If ATC determines, before an approach clearance is issued, that it is no longer necessary to apply speed adjustment procedures, they may advise the pilot to “resume normal speed” or “resume published speed.” Normal speed is used to terminate ATC assigned speed adjustments on segments where there are not published speed restrictions. “Resume normal speed” does not cancel published restrictions on instrument procedures and does not relieve the pilot of those speed restrictions.



**3.29. Operating Near other Aircraft.** Do not allow the aircraft to be flown so close to another that it creates a collision hazard [14 CFR Part 91.111]. **(T-0)**. Use 500 feet of separation as an approximate guide except for:

3.29.1. Authorized formation flights.

3.29.2. Emergency situations requiring assistance from another aircraft. If an emergency requires visual checks of an aircraft in distress, exercise extreme care to ensure this action does not increase the overall hazard. The capabilities of the distressed aircraft and the intentions of the crews involved must be considered before operating near another aircraft in flight.

3.29.3. MAJCOM-approved maneuvers in which participants are aware of the nature of the maneuver and qualified to conduct it safely (e.g., interceptor visual identification training).

**3.30. Dropping Parachutists, Stores, or Other Objects.** Do not allow objects to be dropped except in an emergency or for mission accomplishment. **(T-2)**. Report any accidental loss of equipment, aircraft parts, or cargo in accordance with AFMAN 10-206 and AFMAN 91-223.

**3.31. Fuel Jettison.** Do not jettison fuel except in an emergency or when required for mission accomplishment. **(T-3)**. When jettisoning fuel and circumstances permit, provide the appropriate ATC or flight service facility with intentions, altitude, location, and completion time. Report any jettisoning of fuel in accordance with AFMAN 10-206.

**3.32. Radio, Laser, and Other Electromagnetic Emitter Restrictions.** Equipment which transmits radio, laser, or other energy will only be operated for the intended purpose and in the authorized manner to prevent unintentional interference, damage, or injury. **(T-1)**.

**3.33. Communication Equipment.** If suitably equipped, at least one aircrew member will monitor at least one emergency frequency at all times as mission and operational conditions permit. **(T-3)**. Report distress or emergency locator transmitter (ELT) transmissions to ATC.

**3.34. Navigation Equipment.**

3.34.1. Aircrew will ensure approved primary means of navigation is operational and monitor navigation system integrity (e.g., GPS, VOR, TAC) [14 CFR Part 91.225]. **(T-0)**.

3.34.2. The PIC will not navigate using a TACAN unless valid azimuth and range information are available (i.e., a TACAN broadcasting range with no valid azimuth or a TACAN broadcasting azimuth with no valid range must be considered unusable). **(T-0)**.

**3.35. Transponder Operations.** [14 CFR Part 91.215] Transponders may be operated in different modes: Mode 3A/C, Mode 4/5, Mode S (ELS and EHS) and “ADS-B Out.” **Figure 3.1** summarizes the emissions for each mode. Transponders should be operated in the mode with the lowest emissions required for mission execution or airspace requirements.

3.35.1. Aircrew will generally operate the Mode 3A/C transponder in accordance with ATC instructions, host nation procedures, or theater SPINS. **(T-0)**.

3.35.2. Aircrew will operate Mode S, ADS-B, and Mode 4/5 transponders in accordance with MAJCOM directives. **(T-1)**. If operating with the Mode S flight ID, ensure the flight ID matches the call sign on the flight plan. **Note:** When the flight plan call sign is less than seven characters, place blank spaces at the end.



3.35.3. Aircrew will operate with the transponder in the altitude reporting mode at all airports any time the aircraft is positioned on any portion of a controlled movement area or as directed by the airfield guidance.

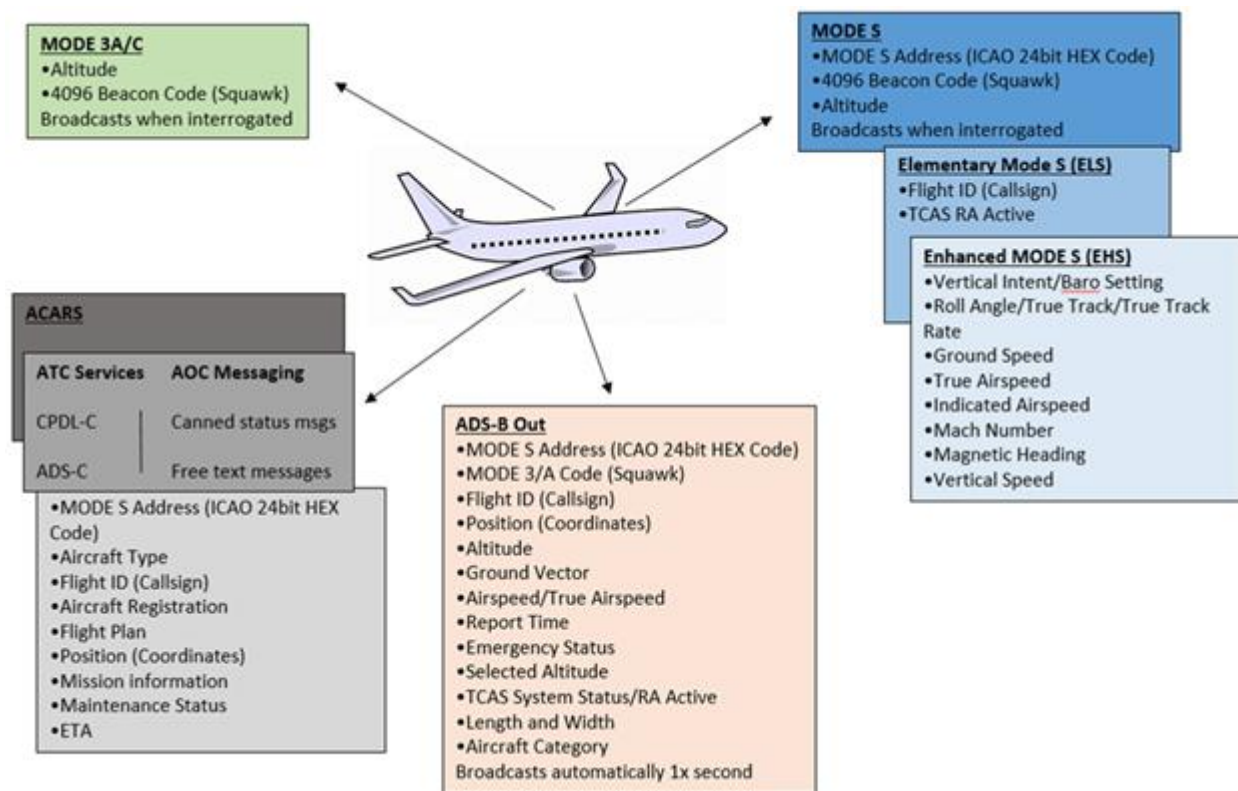
3.35.4. Aircraft will squawk 2000 in the absence of any ATC directions or regional air navigation agreements [ICAO Doc 8168 Volume 1, *Aircraft Operations – Flight Procedures*]. (T-0).

3.35.5. [NAS Only] VFR aircraft normally squawk either 1200 or an ATC-assigned flight following code (including Slow Speed Low Altitude Training Route [SR]) [AIM 4-1-20].

3.35.6. [NAS Only] Aircraft operating VFR or IFR in restricted areas, warning areas, or on a VFR military training route (VR) will squawk 4000 unless another code has been assigned by ATC [JO 7110.65]. (T-0).

3.35.7. [NAS Only] Aircraft operating in or near the Washington DC Special Flight Rules Area or Flight Restricted Zone must refer to the appropriate publication for transponder procedures to prevent intercept. (T-0).

**Figure 3.1. Transponder Emission Summary.**



**3.36. Automatic Dependent Surveillance – Broadcast (ADS-B) Operations.** [14 CFR Part 91.225; 14 CFR 91.227; AC 20-165; AC 20-172; AIM 4-5-7] “ADS-B Out” refers to an aircraft broadcasting its position and other information. “ADS-B In” refers to an aircraft with installed equipment compliant with DO-260, *Minimum Operational Performance Standards for 1090 MHz ADS-B*, DO-282, *Minimum Operational Performance Standards for Universal Access Transceiver (UAT) ADS-B*, for 978 MHz, and airworthiness approval, receiving the broadcasts and messages

from the ADS-B network. **Note:** A portable ADS-B receiver may be used for situational awareness and provides similar information as “ADS-B In,” however it does not make an aircraft “ADS-B In” equipped.

3.36.1. Pilots should refer to the FLIP AP series and ICAO State AIPs for “ADS-B Out” requirements outside the NAS. **Note:** Arrangements with foreign governments or other entities may address military aircraft accommodations regarding “ADS-B Out” and similar expectations. Crews should be aware that alternate routing may be provided.

3.36.2. Request approval through the appropriate command and control channels, if not ADS-B equipped or missions that require “ADS-B Out” Off operations.

3.36.2.1. Consult the FCG for country specific requirements.

3.36.2.2. Some international agreements afford U.S. military aircraft guarantees of access and accommodation.

3.36.3. **[NAS Only]** “ADS-B Out” requirements apply to the airspace defined in 14 CFR Part 91.225 regardless of whether the operation is conducted under VFR or IFR. The DoD has accommodations for this requirement:

3.36.3.1. **[NAS Only] “ADS-B Out” Non-equipped Aircraft.** In accordance with FAA Accommodation Memorandum, non-equipped ADS-B aircraft, in accordance with [paragraph 3.36.3.3](#), are authorized to operate in airspace areas where “ADS-B Out” is required until 31 December 2024 unless superseded, rescinded, or extended. **Note:** This authorization does not relieve DoD-contracted and civil operators from the requirement to equip pursuant to 14 CFR 91.227 with “ADS-B Out” if they are operating in ADS-B airspace while conducting operations not on behalf of the DoD.

3.36.3.2. **[NAS Only] “ADS-B Out” Equipped Aircraft.** In accordance with FAA accommodation memorandum dated 16 September 2019, aircraft equipped with “ADS-B Out,” in accordance with [paragraph 3.36.3.3](#), are authorized to turn “ADS-B Out” OFF as determined by MAJCOM. If an aircraft is operating with “ADS-B Out” OFF, the pilot is required to operate either Mode 3A/C or Mode S. **(T-0). Exception:** Operations granted an FAA exemption to [paragraph 3.35.1](#).

3.36.3.3. **[NAS Only]** The following aircraft are authorized to use the accommodations above:

3.36.3.3.1. Aircraft owned and operated by DoD;

3.36.3.3.2. DoD-contracted aircraft that have been given public aircraft status by DoD when conducting operations on behalf of the DoD;

3.36.3.3.3. Civil aircraft when operating on behalf of the DoD; and

3.36.3.3.4. Foreign State aircraft conducting operations in U.S. airspace, pursuant to an agreement or arrangement with DoD.

**3.37. TCAS Operations.** If operating with the TCAS on, select the TCAS mode that provides both traffic alerts (TAs) and resolution advisories (RAs), in accordance with the aircraft manual, formation flight requirements, MAJCOM guidance, mission requirements, theater SPINS, or host-nation agreements [14 CFR Part 91.223].

3.37.1. Pilots will respond to all RAs regardless of ATC instructions, right-of-way rules, cloud clearance requirements, or other VFR or IFR flight rules, as directed by TCAS unless doing so would jeopardize the safe operation of the aircraft (e.g., descent into obstacles). **(T-1)**.

3.37.1.1. Do not deviate from an assigned ATC clearance based solely on traffic advisory information. **(T-1)**. Attempt to attain visual contact and maintain safe separation.

3.37.1.2. In the event of a resolution advisory (RA), alter the flight path only to the extent necessary to comply with the RA. **(T-1)**.

3.37.1.3. After deviating from an ATC clearance in response to an RA, notify ATC of the deviation as soon as practical and promptly return to the current ATC clearance when the traffic conflict is resolved or obtain a new clearance. **(T-0)**.

3.37.2. [AC 120-55] To preclude unnecessary transponder interrogations and possible interference with ground radar surveillance systems, do not activate TCAS (“TA-Only” or “TA/RA”) until taking the active runway for departure. Following landing and clearing the runway, de-select TCAS from “TA-Only” or “TA/RA.”

**3.38. Communication, Navigation, and Surveillance Equipment Malfunctions.** When operating in controlled airspace under IFR, report as soon as practical to ATC the malfunction of navigational, air-to-ground communications, or surveillance capability in accordance with the Flight Information Handbook [14 CFR Part 91.187]. **(T-0)**.

**3.39. Terrain Awareness and Warning Systems (TAWS).** Aircrew will comply with appropriate aircraft flight manual procedures and MAJCOM guidance upon receipt of a Ground Proximity Warning System (GPWS), TAWS, Enhanced GPWS (EGPWS), or Ground Collision Avoidance System (GCAS) warning. During visual meteorological conditions (VMC) flight, terrain warnings do not need to be followed if the pilot can verify the warning is false by visual contact with terrain or obstacles.

**3.39. (AFMC) Terrain Awareness and Warning Systems (TAWS).** For operational, training and proficiency sorties, AFMC aircrew will follow basic and MDS specific guidance in AFMAN 11- 2FTV3. **(T-2)**. Test sorties will follow specified guidance in an approved test plan. **(T-2)**. In the event no guidance is published in AFMAN 11-2FTV3, follow lead MAJCOM guidance.

**3.40. Carry-On Equipment.** Carry-on communication, navigation, and surveillance equipment may be used as authorized by the MAJCOM.

**3.41. Formation Flights (Including Air Refueling).** [14 CFR Part 91.111, FAA JO 7610.4] Accomplish formation flights only as authorized by the MAJCOM. Formation leads will brief formation flight operations to all participating aircraft. **(T-0)**. Formation flights may operate in RVSM airspace if all participating aircraft are RVSM compliant or approved by ATC [14 CFR Part 91.706]. **(T-0)**.

**3.41. (AFMC) Formation Flights (Including Air Refueling).** Formation flights are authorized.

3.41.1. Transponder Operations.

3.41.1.1. Only one aircraft (normally the lead) of a standard formation should operate the transponder in accordance with [paragraph 3.35](#) [FAA JO 7110.65].

3.41.1.2. -[FAA JO 7610.4] Unless otherwise directed, all aircraft within a non-standard formation should squawk an ATC assigned Mode 3A/C beacon code until established

within the assigned altitude block. **(T-0)**. Unless otherwise directed, receivers will not squawk when less than 3NM from the tanker. **(T-1)**.

3.41.1.3. Unless otherwise directed, when aircraft interval exceeds 3 NM, both the formation lead and last aircraft will squawk the assigned Mode 3A/C beacon code. **(T-1)**.

3.41.1.4. If equipped, other formation elements should use “ATC Off” mode in accordance with [paragraph 3.41.1.1](#) and [paragraph 3.41.1.2](#). This mode disables squawks, Mode S air-to-ground transmissions, and ADS-B-Out squitters, but maintains Mode S air-to-air transmissions (which are used by TCAS). If not equipped with “ATC off”, other formation elements should disable squawks, Mode S, and “ADS-B-Out” in accordance with [paragraph 3.41.1.1](#) and [paragraph 3.41.1.2](#).

#### 3.41.2. TCAS Operations.

3.41.2.1. Formation leads (and last aircraft, when formation length exceeds 3 NM) will operate in traffic advisory mode unless otherwise required by ATC, host-nation agreement or specified in the MDS-specific guidance. **(T-0)**. If operating in “ATC Off” mode, formation elements should also operate in “TA-Only” mode. If not operating in “ATC Off” mode, TCAS will not be available if Mode S is disabled and can be operated in standby.

3.41.2.2. During refueling operations, the tanker aircraft will operate in traffic advisory mode. **(T-0)**. If the receiving aircraft is TCAS equipped, it can operate in traffic advisory mode if using “ATC Off”, otherwise TCAS can be operated in standby.

3.41.3. Non-standard formation flights may be conducted when approved by ATC, operating under VFR in VMC, operating within an authorized Altitude Reservation (ALTRV), operating under the provisions of a letter of agreement, or operating in airspace specifically designated for a special activity.

**3.42. Aerobatics.** Pilots may conduct aerobatic flight when operating within coordinated special use airspace (SUA), temporary flight restriction (TFR) if authorized, Aerobatic Training Area, ATC-Assigned Airspace (ATCAA), or if not operating in these areas in accordance with 14 CFR Part 91.303. **(T-0)**. Pilots of aircraft deployed or based at overseas locations will operate in accordance with applicable host-nation agreements or ICAO SARPs. **(T-0)**. If the aircraft operating requirements (e.g., altitude requirements, maximum airspeeds) dictated in the host-nation agreement are less restrictive than USAF guidance, the most restrictive guidance shall be used. **(T-1)**.

**3.43. Air Combat Tactics.** Air combat tactics and air-to-ground tactics which involve aerobatic type maneuvering must be performed in SUA, ATCAA, military training routes (MTRs), or host-nation approved airspace in accordance with the guidelines in AFI 11-214, *Air Operations Rules and Procedures*. Aircraft deployed or based at overseas locations will operate in accordance with applicable host-nation agreements or ICAO SARPs. **(T-0)**. If the aircraft operating requirements (e.g., altitude requirements, maximum airspeeds, dropping of objects) dictated in the host-nation agreement are less restrictive than USAF guidance, the most restrictive guidance shall be used. **(T-1)**.

**3.44. Temporary Flight Restriction (TFR) Airspace.** [14 CFR Part 91.137, 14 CFR Part 91.138, 14 CFR Part 91.145] Do not operate within a TFR without authorization. **(T-0)**.

**3.45. Operating at Non-towered Airports.** [AIM 4-1-9, AIM 4-3-3] Use the runway favored by the winds unless safety, air traffic considerations, or mission accomplishment makes another option more suitable. All common traffic advisory frequency and flight service station (FSS) calls will be in accordance with the AIM. **(T-0)**. UAS operations are prohibited at uncontrolled fields when other traffic is present. **(T-2)**.

**3.46. Simulated Instrument Flight.** [14 CFR Part 91.109] For non-instrument qualified pilots, a safety observer who is able to clear outside at all times should accompany the flight either as an aircrew member or in a chase aircraft. If a chase aircraft is used, maintain continuous visual contact and two-way communications between aircraft. A safety observer is defined as a current and qualified instrument pilot or a fighter weapons systems operator (or other MAJCOM-designated aircrew member) with access to a set of flight controls.

3.46.1. MAJCOMs must approve the use of vision restricting devices and provide specific approval for use during takeoffs and landings. Do not use a vision restricting device without a safety observer. **(T-2)**. Maintain at least 2,000 feet of obstruction clearance when using vision restricting devices if the safety observer is in a chase aircraft, not qualified as a pilot, or does not have full view of the flight instruments and access to flight controls. **(T-2)**.

3.46.1. **(AFMC)** Use of vision restricting devices during takeoffs and landings is approved when required by a test plan. Safety observers will be pilot qualified in the aircraft flown, have direct access to the flight controls, have full view of the flight instruments, and be able to see outside. **(T-2)**.

3.46.2. When not on an IFR flight plan, the aircraft must be equipped with a functional two-way radio and have the airport environment in sight when established on the final segment of an approach. **(T-1)**.

**3.47. Simulated Emergency Flight.** Terminate simulated emergency training if an actual emergency occurs.

3.47.1. MAJCOMs must provide guidance when an instructor pilot or flight examiner does not have immediate access to the aircraft controls.

3.47.1. **(AFMC)** Guidance for practicing emergency procedures is published in AFMAN 11-2FTV3 and the MDS specific attachments.

3.47.2. Passengers will not be onboard without MAJCOM and PIC authorization.

3.47.2. **(AFMC)** The FOA may allow a Federal Aviation Administration (FAA) flight examiner to observe pilot or flight engineer performance for an addition of a certificate or rating given as part of an Air Force flight evaluation. The FAA flight examiner will occupy an observer position only. **(T-3)**.

3.47.3. Single-pilot aircraft require day VMC (N/A for UAS). **(T-2)**.

3.47.4. Multi-pilot aircraft in day IMC require weather conditions at or above published circling minimums for the approach to be flown (N/A for UAS). **(T-2)**.

3.47.5. Multi-pilot aircraft at night require weather conditions at or above 1,000 foot ceiling and 2 statute miles (SM) visibility or circling minimums, whichever is higher (N/A for UAS) **(T-2)**.

3.47.6. At controlled fields where Simulated Flameout, Forced Landing, or Emergency Landing Patterns (SFO/ELP) maneuvers are conducted, the facility air traffic manager shall issue a letter of agreement with the appropriate military authority and adjacent facilities as required. Follow letter of agreement guidance found in FAA Joint Order (FAA JO) 7610.4. **(T-0).**

**3.48. Vertical-Lift Operations.** For this manual, tilt-rotor aircraft in vertical-flight mode will follow helicopter guidance. **(T-1).** MAJCOMs will provide guidance on determining phase-of-flight for aircraft capable of transition to/from vertical flight.

**3.48. (AFMC) Vertical-Lift Operations.** Guidance for determining phase-of-flight for aircraft capable of transition to/from vertical flight is contained in AFMAN 11-2FTV3.

## Chapter 4

### MISSION PLANNING

**4.1. General.** [FAA Pilot/Controller Glossary] It is important not to confuse or use terms inappropriately. Flight conditions do not always correspond to the type of flight plan filed.

4.1.1. Instrument flight rules (IFR) are a set of rules governing the conduct of instrument flight. **(NAS Only)** This is a term used by pilots and controllers to indicate type of flight plan. The term “IFR” is also used in the United States to indicate weather conditions that are less than minimum VFR requirements.

4.1.2. Instrument meteorological conditions (IMC) are weather conditions expressed in terms of visibility, distance from clouds, and ceilings less than the minima specified for visual meteorological conditions.

4.1.3. Visual flight rules (VFR) govern the procedures for conducting flight under visual conditions. **(NAS Only)** The term “VFR” is also used in the United States to indicate weather conditions that are equal to or greater than minimum VFR requirements. In addition, it is used by pilots and controllers to indicate type of flight plan.

4.1.4. Visual meteorological conditions (VMC) are weather conditions expressed in terms of visibility, distance from clouds, and ceilings equal to or better than specified minima.

**4.2. Flight Authorization.** Flights in USAF aircraft will be authorized and documented in accordance with AFI 11-401 and MAJCOM guidance. **(T-1).**

4.2.1. **(Added-AFMC)** All one-time flights of aircraft (including but not limited to un-airworthy/crash-damaged, flight envelope restricted, etc.) require HQ AFMC/A3 approval. Proposed flights with any engine or primary aircraft system affecting safety of flight inoperative, unless required under an approved test plan, require HQ AFMC/A3 approval (for example, landing gear, engines, IFR capability, hydraulic, electrical, fuel, or flight control). Maintenance downgrade of Red “X” does not constitute operational approval. Submit requests for operational approval to HQ AFMC/A3V for coordination. Include in the request (as a minimum): aircraft history; engineering analysis/coordination; a detailed aircrew Risk Management analysis; and flight restrictions. **(T-2).**

4.2.2. **(Added-AFMC)** **Table 4.5.** lists pilot requirements and restrictions when flying AFMC aircraft. In addition, reference AFI 11-401\_AFMCSUP, *Aviation Management*.

4.2.3. **(Added-AFMC)** Only mission qualified, mission essential personnel, operational support fliers, or Flight Examiners IAW AFI 11-202V2, *Aircrew Standardization/Evaluation Program*, are permitted on:

4.2.3.1. **(Added-AFMC)** Functional check flights (except O-8F). **(T-2). Exception:** Minimum number of maintenance technicians needed to perform airborne FCF duties that the aircrew cannot complete may fly on Functional Check Flights (FCF) as MESPs. This does not preclude requisite training for crewmembers undergoing FCF mission qualification IAW AFMAN 11-2FTV1. **(T-2).**

4.2.3.2. **(Added-AFMC)** The first flight of a new aircraft. **(T-2).**

4.2.3.3. **(Added-AFMC)** Aircraft carrying hazardous materials. **(T-2).**



4.2.3.4. **(Added-AFMC)** Flights that the FOA or other authority defines as hazardous and/or higher than safety reviewed LOW risk test missions unless specifically approved in the applicable safety package(s). **(T-2)**.

4.2.3.5. **(Added-AFMC)** Flights to identify the flight characteristics of aircraft altered by a configuration change. **(T-2)**.

4.2.3.6. **(Added-AFMC)** Flights to test or check the structural integrity of airframes or engines. **(T-2)**.

4.2.3.7. **(Added-AFMC)** Flights to discover or expand flight envelopes. **(T-2)**.

4.2.3.8. **(Added-AFMC)** Record attempts. **(T-2)**.

**4.3. Pilot in Command.** The PIC must be current and qualified in the aircraft to be flown or under the supervision of a current and qualified instructor pilot (to include supervision from a formation position). **(T-0)**. If any portion of the flight will be conducted in IMC or under IFR, the PIC must hold a current instrument qualification. **(T-0)**. **Exception:** Student pilots enrolled in Undergraduate Flying Training courses, Introduction to Fighter Fundamentals, and Pilot Instructor Training may act as PIC for syllabus-directed solo flights in accordance with FAA JO 7610.4. **(T-0)**.

4.3.1. **(Added-AFMC)** The PIC will not allow non-pilots to control the aircraft during critical phases of flight without specific FOA approval. **(T-2)**. **Exception:** TPS graduates or TPS students performing qualitative evaluations in conjunction with a TPS syllabus event or short term qualitative evaluation mission in accordance with AFMAN 11-2FTV3.

**4.4. Approval Authority.** The flight authorization will designate the PIC. **(T-1)**. The designated PIC is responsible for the safety of the aircraft, the formation, and its occupants.

**4.5. Flight Plans.** File a flight plan in accordance with FLIP *General Planning* or MAJCOM guidance. **(T-1)**. If unable to file on the ground, once airborne, file a flight plan as soon as practicable. Mission requirements drive selection of flight rules (IFR or VFR).

4.5.1. Pilots operating in international airspace will file an international flight plan unless MAJCOM or contingency guidance specifies otherwise. **(T-2)**.

4.5.2. List passengers on a DD Form 2131, *Passenger Manifest*, or a MAJCOM-approved form. **(T-2)**. File the manifest and crew list with the flight plan, the passenger service facility, or other responsible agency. **(T-2)**. Notify command and control prior to departure if there is a passenger manifest (or crew list) change. **(T-2)**. When able, process any changes with the original processing facility or a responsible agency.

4.5.2.1. **(Added-AFMC) Parachutist Manifests.** All parachutists will be listed on DD Form 2131, *Passenger Manifest*. **(T-2)**. Parachutists will provide the aircrew with a copy of the manifest and the aircrew will file this list with the mission paperwork. **(T-2)**.

4.5.3. The PIC may make changes to the original filed flight plan without re-filing provided the change does not penetrate an air defense identification zone (ADIZ), the controlling ATC agency approves the change for an IFR flight, or the changes comply with applicable host-nation rules.

4.5.4. **[NAS Only]** When landing at a non-towered civilian airfield or part-time-towered airports when the control tower is not operating, the pilot is responsible for ensuring that flight



plans are closed either by contacting an FSS, the originating military base operations, or through an ATC facility [14 CFR Part 91.153 and 14 CFR Part 91.169]. **(T-0)**.

4.5.5. By filing a flight plan, the PIC certifies:

4.5.5.1. The flight was authorized in accordance with AFI 11-401;

4.5.5.2. Compliance with **paragraph 4.6**;

4.5.5.3. The flight plan has been reviewed for completeness and accuracy;

4.5.5.4. The flight complies with ADIZ restrictions and special use airspace or MTR scheduling and coordination procedures specified in FLIP and NOTAMs.

#### **4.6. Mission Planning Requirements.**

4.6.1. Obtain current and relevant information including but not limited to:

4.6.1.1. Weather observations and forecasts. **(T-0)**.

4.6.1.2. NOTAMs, to include special use airspace and TFRs **(T-0)**;

4.6.1.3. Airfield Suitability and Restrictions Report and Global Decision Support System (GDSS) information if required by MAJCOM;

4.6.1.3.1. **(Added-AFMC)** AFMC aircrews will review the ASRR/(and GDSS if required) when planning missions to other than local area airfields. **(T-2)**. A local area airfield is defined as an airfield (civil, military, or joint use) used by a unit for flight operations where local airfield information is known and routinely monitored by the operations supervision. A list of local area designated airfields will be approved by the Unit Commander and published in the unit local area procedures instruction. **(T-2)**. General ASRR restrictions (e.g., day only, VMC only, etc.) are applicable to all AFMC operations. Aircraft specific restrictions apply to AFMC users of like aircraft. The ASRR may not be used to grant relief from any guidance contained in an AFMAN/AFI or AFMC supplement. **(T-2)**.

4.6.1.4. FLIP, to include appropriate navigational and plotting charts with current vertical obstructions **(T-0)**;

4.6.1.5. Fuel requirements **(T-0)**;

4.6.1.6. Bird advisories and hazard information **(T-2)**;

4.6.1.6. **(AFMC)** Unit Commanders will ensure the Avian Hazard Advisory System (AHAS) is available and accessible to unit flight supervisors, supervisors of flying (SOF), scheduling offices, and aircrews. **(T-2)**. Units will establish procedures for risk assessment of bird hazards and provide local operating procedures to be used to fly in areas that are forecasted or reported to have a bird advisory hazard of MODERATE or greater. **(T-2)**. Reference AFI 91-212 and AFMAN 11-2FTV3 for additional bird avoidance guidance.

4.6.1.7. Special Departure Procedures (SDP) if authorized by MAJCOM;

4.6.1.7. **(AFMC)** The use of an SDP is authorized in AFMC if required for a Test or Syllabus Training sortie or has been approved for use by the FOA and AFMC/A3V. **Note:** reference **paragraph 5.8** for SDP approval.

4.6.1.8. As applicable: Space Based Augmentation System (SBAS) coverage and NOTAMs, and air traffic management Service Availability (e.g., ADS-B services) **(T-0)**;

4.6.1.9. Applicable MAJCOM/COCOM guidance (e.g., flight crew information files [FCIFs], flight crew bulletins [FCBs]).

4.6.1.10. **(Added-AFMC) Risk Management (RM) Worksheets.** All AFMC flying units will use an RM assessment worksheet to identify and manage risks associated with their flying mission. **(T-2)**. The assessment worksheet will have four areas: human, mission, media, and machine. Each area will have command defined elements to include Human (crew rest, crew currency), Mission (complexity, risk level), Media (weather, time of day, level of IFR/VFR ATC traffic separation services provided), and Machine (aircraft MX factors), as well as elements defined and tailored at the unit level. **(T-2)**. The worksheet will use a unit defined weighting/scoring system with a total that is used to determine the overall assessed risk for the flight. **(T-2)**. Unit commanders will establish threshold criteria and the approval level for flights identified as elevated risk. At a minimum, the assessment will be reviewed by a government or military unit designated operations supervision authority other than the aircraft commander prior to execution of that sortie. **(T-2)**. Worksheet data for all flights will be tracked and reviewed periodically by the FOA. **(T-2)**.

4.6.2. Comply with international procedures in FLIP *General Planning*, FLIP *Area Planning*, AIP, and the FCG. **(T-1)**. Observe applicable host-nation procedures via terms of clearance. **(T-0)**. [DoDI 4540.01] Outside the NAS, observe ICAO guidance when practical and compatible with the mission. Be prepared to address any potential freedom of navigation issues, consistent with DoD and USAF guidance. Report any suspected customs, agriculture, or immigration violations to host nation authorities. **(T-1)**.

#### **4.7. Civil, Military, and Joint-Use Airports.**

4.7.1. MAJCOMs may authorize filing to or landing at civil airfields. Use of civil facilities not governed by agreement or law may result in landing and facility fees.

4.7.1. **(AFMC)** FOAs may authorize operations at civil airports not P-coded in an Enroute Supplement if the airport manager grants permission in advance. Consider items (not inclusive) such as government fuel contract, airfield landing fees, airfield entry control procedures, airfield surveillance, airfield security, and rescue/fire response.

4.7.2. "P-coded" Civil Airports (as listed in the IFR Supplement). Aircrew may file to or land USAF aircraft at US civil public airports when:

4.7.2.1. In an emergency;

4.7.2.2. Flying a helicopter or C-coded aircraft (e.g., C-130, C-12, C-40);

4.7.2.3. Necessary in the recovery of active air defense interceptor aircraft;

4.7.2.4. An alternate is required and no other suitable airport is available;

4.7.2.5. The wing commander or higher authority approves the flight and the airport manager grants permission in advance; or,

4.7.2.6. A U.S. Government tenant unit (e.g., ANG, U.S. Coast Guard) is listed for the airport of intended landing and airport facilities or ground support equipment can support the aircraft concerned.

4.7.3. Aircrew may file to and land at US military and Joint- Use (i.e., MIL/CIV) fields. Flying unit commanders must approve fixed-wing aircraft operations from other than established landing surfaces (e.g., highways, pastures).

4.7.4. Ensure off-station training achieves valid training requirements while presenting a positive view of the USAF and avoids the appearance of government waste or abuse.

4.7.5. Flying units will coordinate with respective ATC agencies and civil airport authorities before conducting volume training at civil airports or within airways. **(T-3)**.

#### **4.8. UAS Airfields and Operations.**

4.8.1. Except for divert or emergency situations, MAJCOMs shall approve all airfields authorized for use by UAS. Operations may require an approved certificate of authorization and appropriate letter of agreement between the employing unit, ATC, and airfield management

4.8.1. **(AFMC)** The FOA will designate authorized airfields for UAS Groups 4 and 5 in the unit supplement to AFMAN 11-2FTV3. **(T-2)**. Prior to operating out of a new airfield, a site-survey will be conducted to review airfield layout, obstacles (close & distant) airspace requirements, and any local unique procedures. **(T-2)**. Comply with AFMAN 11-502, *Small Unmanned Aircraft Systems*, for Group 1 thru 3 operations. **(T-2)**.

4.8.2. For operations outside special use airspace (or when required within), the mission tasking authority shall coordinate through AF/A3O to obtain a certificate of authorization or waiver from the FAA. **(T-0)**. Before submitting, verify the certificate of authorization complies with current FAA requirements at <http://www.faa.gov/about/initiatives/uas>.

**4.9. Aviation Into-Plane Reimbursement Card (AIR Card®) Responsibilities.** Aircrew will use the government AIR Card® in accordance with AFI 11-253, *Managing Off-Station Purchases of Aviation Fuel and Ground Services*. Further information, including documentation procedures and updated lists of contract fixed-base operators (FBO), is available at <http://www.aircardsys.com/>.

#### **4.10. Weather Information.**

4.10.1. Aircrew will use the following prioritized list of authorized weather sources **(T-1)**:

4.10.1.1. MAJCOM-approved weather source (e.g., home or local installation OSS Weather Flight, MAJCOM-designated centralized briefing facility (or equivalent), commercial websites, flight planning services). **Note:** MAJCOMS will provide guidance on use of non-DoD weather sources;

4.10.1.1. **(AFMC)** When DoD weather service is not available or incomplete, aircrews will obtain weather by any means possible, to include nearest flight service station (FSS), foreign military, civilian automatic terminal information service (ATIS), or through fixed base operators. **(T-2)**.

4.10.1.2. Regional Operational Weather Squadron (OWS);

4.10.1.3. Other DoD military weather sources (e.g., US Navy weather facilities);

4.10.1.4. Other U.S. Government (USG) weather facilities or services (e.g., National Weather Service, FAA);

4.10.1.5. Foreign civil or military weather service (use only when DoD military resources or USG services are unavailable in OCONUS locations).

4.10.2. Runway Visual Range (RVR) reports apply to all takeoffs, landings, and straight-in approaches to the runway and take precedence over any other visibility report for that runway. Aircrew will use the static RVR when available. **(T-2)**. If a variable RVR report is received, aircrew will apply the lowest reported value. **(T-2)**.

4.10.2.1. -[14 CFR Part 91.175] Except for Category II or Category III minimums, if RVR minimums for takeoff or landing are prescribed on an instrument approach procedure but RVR is not reported for the runway of intended operation, the RVR minimum shall be converted to ground visibility in accordance with **Table 4.1 (T-0)**. This converted visibility is now the minimum visibility for takeoff or landing on that runway. **(T-0)**. When converting RVR values, do not interpolate; use the next higher RVR value. **(T-0)**.

4.10.2.2. If RVR is unavailable, use prevailing visibility.

**Table 4.1. RVR to Prevailing Visibility Conversion.**

| RVR (feet) | Visibility (statute miles) |
|------------|----------------------------|
| 1,600      | 1/4                        |
| 2,400      | 1/2                        |
| 3,200      | 5/8                        |
| 4,000      | 3/4                        |
| 4,500      | 7/8                        |
| 5,000      | 1                          |
| 6,000      | 1 1/4                      |

**4.11. Notices To Airmen (NOTAMs).** [AIM 5-1-3; AFI 11-208, *Department of Defense Notice to Airmen System*; FAA Order 7930.2, *Notices to Airmen (NOTAM)*; ICAO Annex 15] The NOTAM system distributes time-critical aeronautical information. NOTAMs typically include information of a temporary nature or not sufficiently known in advance to permit publication on aeronautical charts or in other operational publications. Obtain NOTAMs from the Defense Aeronautical Information Portal (DAIP) website at <https://www.daip.jcs.mil/> **(T-2)**.

4.11.1. If the airfield is not covered by DAIP, a plain language notice in red font is displayed advising the user of that fact. In this case, contact the airfield manager or associated FSS directly for NOTAM information.

4.11.1.1. If unavailable, obtain NOTAMS by contacting one of the installations listed in FLIP or the nearest Aeronautical Information Service. **(T-2)**.

4.11.1.1. **(AFMC)** If using non-USG products or databases, obtain the associated NOTAMs, alerts, and advisories from the respective country or agency. **(T-2)**. The FOA may approve the use of Non-USG terminal procedures after a TERPS review. The single point of contact for all requests is the AFMC TERPS office (HQ AFMC/A30, DSN 986-

0061/0123 commercial (937) 656-0061/0123 or [hqafmc.terps@us.af.mil](mailto:hqafmc.terps@us.af.mil). Submit requirements directly to the TERPS office immediately upon mission notification. Minimum 15 days advance notice is desired. Instrument procedures are approved for specific missions, not blanket use. PICs will comply with restrictions and recommendations contained in the TERPS evaluation. Approval request must include airfield name/ICAO, desired procedure(s), copy of approach plate (or Jeppesen page number), mission date, POC and phone number. Locally developed training must include differences in symbology, language or translation, weather minimums, host nation NOTAM retrieval, equipment and airspace requirements. **(T-2)**.

4.11.1.2. If using non-USG products or databases, obtain the associated NOTAMs, alerts, and advisories from the respective country or agency. **(T-2)**. See AFI 11-208, *Department of Defense Notice to Airmen System* for more information.

4.11.2. Abbreviations are explained in the FIH.

4.11.3. Special interest NOTAMs for VFR flight in the NAS:

4.11.3.1. Tethered balloons are depicted as restricted areas on IFR enroute low-altitude charts and FAA sectional charts.

4.11.3.2. Glider and parachute operations are depicted with symbols on FAA sectional charts. Operations may be announced via NOTAM or listed in the enroute supplements.

**4.12. Critical Distance Measuring Equipment (DME) NOTAMs.** [FAA Aeronautical Information Services] A critical DME is a DME facility that, when not available, results in navigation service which is not sufficient for DME/DME/IRU operations along a specific route or procedure. The required performance assumes an aircraft's navigation system meets the minimum standard for DME/DME area navigation systems or the minimum standard for DME/DME/IRU area navigation systems. Critical DME facilities are identified on the appropriate instrument procedure. Pilots of DME/DME/IRU-equipped aircraft should check NOTAMs to verify the operation of critical DME facilities. The current list of critical DME facilities may be found on the FAA website at [https://www.faa.gov/air\\_traffic/flight\\_info/aeronav/criticaldme/](https://www.faa.gov/air_traffic/flight_info/aeronav/criticaldme/).

**4.13. Performance-Based Navigation (PBN).** [FAA AC 90-100, FAA AC-90-105, FAA AC 90-108] The PIC will not execute PBN operations (airspace, routes, and procedures) without operational approval. **(T-1)**. The PIC will comply with MAJCOM guidance, performance requirements, and specifications appropriate for the airspace, routes, and procedures to be flown [ICAO Doc 9613]. **(T-1)**. **Exception:** Non-equipped aircraft with exemptions or special procedures.

4.13.1. The PIC will retrieve all NAVAIDs, navigational fixes, and PBN instrument procedures from a current navigation database. [AC 90-100]. **(T-0)**. **Note:** MAJCOMs may publish guidance for operations with an expired navigation database.

4.13.1. **(AFMC)** Aircrews may continue a mission with an expired database if the database information required for the planned flight (to include potential alternate or divert airfields) can be verified with current FLIP.

4.13.2. MAJCOMs may approve the use of other RNAV systems (i.e., not "suitable" as defined in AC 90-108) to enhance IFR navigation on conventional routes and procedures. Underlying conventional NAVAIDS must be tuned and monitored. **(T-0)**.

4.13.2. (AFMC) Refer to AFMC/A3V SharePoint for the current MDS specific CNS/ATM certifications.

4.13.3. Before flight, confirm the availability of the PBN capability for the intended airspace, route, and procedure (T-0). MAJCOMS will publish MDS-specific information for use of Receiver Autonomous Integrity Monitoring (RAIM) prediction procedures.

4.13.3. (AFMC) Follow MDS lead MAJCOM guidance and Flight Manual procedures for RAIM procedures.

4.13.4. If planning to use a Global Navigation Satellite System (GNSS) for navigation, the PIC will conduct a predictive RAIM check prior to departing. (T-1). **Exception:** If TSO-C145/C-146 equipment is used to satisfy the RNAV requirement, then SBAS equipped aircraft do not need to perform a predictive RAIM check if SBAS coverage is confirmed to be available along the entire route of flight (e.g., aircraft equipped with a Wide Area Augmentation System (WAAS)-enabled GPS). **Note:** MAJCOMS may authorize use of civil (e.g., Standard Positioning Service (SPS)) RAIM prediction services if a Precise Position Service (PPS) RAIM prediction tool is not available.

4.13.4. (AFMC) GNSS and other RNAV equipment may be used as the primary means of navigation if properly certified for the phase of flight and used by qualified aircrew. Refer to AFMC/A3V SharePoint for the current MDS specific CNS/ATM certifications.

4.13.5. If a specified RNP level cannot be achieved, revise the route or delay PBN operations until the appropriate RNP level can be assured. (T-0). Advise ATC if an equipment failure or other malfunction results in the loss of aircraft capability to continue PBN operations. (T-0).

4.13.6. Ensure planned waypoints and procedures are included in the current onboard navigation database prior to flight. (T-0).

4.13.7. Crosscheck the cleared flight plan against current FLIP, the navigation system textual display, and aircraft map display (if applicable). (T-0). Include confirmation of waypoint sequence, reasonability of track angles and distances, altitude or speed constraints, and identification of fly-by or fly-over waypoints. (T-1). Do not execute any procedure for which there is doubt about validity of the navigation database or publications. (T-0).

4.13.8. Do not modify database waypoints using latitude/longitude or place/bearing or insert user-defined waypoints on performance-based routes or procedures except to change altitude or airspeed to assist in complying with an ATC instruction. (T-0). Systems which allow additional waypoints on the track may be used.

4.13.9. The PIC will monitor a lateral deviation display (e.g., course deviation indicator (CDI)) for course errors. (T-0). **Exception:** systems capable of onboard performance monitoring and alerting.

4.13.10. [NAS Only] Radar monitoring is required on all unpublished (random) RNAV routes. (T-0). Refer to FLIP *General Planning*.

4.13.11. If ATC issues a heading assignment taking the aircraft off a procedure, the PIC should not modify the flight plan in the system until:

4.13.11.1. A clearance is received to rejoin the procedure; or

4.13.11.2. The controller confirms a new route clearance.

4.13.12. Pilots will not file a flight plan nor accept a clearance that requires navigating direct to a navigational fix unless the primary navigation equipment onboard the aircraft is certified for the appropriate RNAV capability. **(T-0)**. Pilots of aircraft without the appropriate RNAV capability will reply with “unable” when given a clearance to proceed direct to a fix. **(T-0)**. ATC may provide radar vectors or an alternate routing under these circumstances.

4.13.13. Suitable RNAV systems may be used as a substitute means of navigation or an alternate means of navigation on conventional routes and procedures. Comply with MAJCOM guidance, host-nation, and oceanic procedures. **(T-1)**.

4.13.13.1. Substitute means of navigation refers to using a suitable RNAV system in lieu of out-of-service conventional NAVAIDS or non-installed or non-operable avionics.

4.13.13.2. Alternate means of navigation refers to using a suitable RNAV system in lieu of operational conventional NAVAIDS without monitoring those NAVAIDS. **Note:** Use of a suitable RNAV system as a means to navigate on a final approach segment of an instrument approach procedure based on a VOR, TACAN, or NDB signal, is allowable. The underlying NAVAID must be operational and the NAVAID monitored for final segment course alignment.

4.13.13.3. The following allowances described apply even when a facility is identified as required on a procedure (e.g., “ADF or DME REQUIRED”). Suitable RNAV systems may be used in the following ways:

4.13.13.3.1. Determine aircraft position relative to a distance from a conventional NAVAID.

4.13.13.3.2. Navigate to or from a conventional NAVAID.

4.13.13.3.3. Hold over a conventional NAVAID or DME navigational fix.

4.13.13.3.4. Fly an arc based on DME.

4.13.13.4. The following uses are prohibited:

4.13.13.4.1. Substituting for a NAVAID providing lateral course guidance during the final approach segment of a VOR/TACAN/NDB approach. **(T-1)**. **Exception:** MAJCOMs may seek operational approval to allow RNAV lateral course guidance on the final approach segment in lieu of an out of service NAVAID.

4.13.13.4.2. Lateral navigation on localizer based courses (including localizer back-course guidance) without referencing the raw localizer data. **(T-0)**.

4.13.13.4.3. Navigation with DME/DME/IRU systems (without GNSS/WAAS input) unless specifically authorized by NOTAM or FAA guidance for a specific procedure. **(T-0)**.

4.13.13.4.4. Use of a procedure identified as “NA” (Not Authorized) without exception by a NOTAM. **(T-0)**.

**4.14. Aeronautical Information and Publications.** Aircrew should obtain and use information or publications from USG sources. MAJCOM training is required for use of non-USG publications. **(T-1)**. Do not use aeronautical information that is out of date, incomplete, illegible, contains unfamiliar procedures, or is published in a language other than English. **(T-2)**.



4.14.1. Use electronic equivalent and digital products which do not maintain the original size, scale, format, or color may be authorized by the MAJCOM. **Note:** Paper publications and documents are not required if replicated by electronic means.

4.14.1. (AFMC) Electronic media is acceptable for flight if it complies with Air Force and Command guidance and has MDS-specific Program Manager approval.

4.14.2. Follow MAJCOM or MDS-specific guidance for required publications to be available in the aircraft or accessible to UAS operators (e.g., navigation charts, FIH). **(T-1)**.

4.14.3. Obtain navigation, terrain, and obstacle databases through MAJCOM-authorized processes. Review aeronautical navigation database NOTAMS prior to flight. **(T-2)**.

4.14.4. Digital Product Updates.

4.14.4.1. Update NGA digital products via application-specific update procedures or the NGA's Aeronautical Content Exploitation System (ACES) website at <https://aerodata.nga.mil/AeroBrowser/>.

4.14.4.2. Update FAA digital products via the FAA's Digital Products website at [https://www.faa.gov/air\\_traffic/flight\\_info/aeronav/digital\\_products/](https://www.faa.gov/air_traffic/flight_info/aeronav/digital_products/).

4.14.4.3. Update commercial digital products as required by the publisher.

**4.15. IFR Flight.** Do not depart IFR unless the weather conditions at the destination, from 1 hour before to 1 hour after the estimated time of arrival (ETA), is forecast to be at or above the lowest compatible published approach minimums. **(T-1)**. **Note:** Temporary (TEMPO) conditions may be below compatible published approach minimums. **Exception:** MAJCOMs may authorize filing to a destination with weather below the lowest compatible published approach minimums after publishing supplemental recovery procedures.

4.15.1. [**Helicopter only**] Reduce visibility by one-half, but no lower than one-quarter statute mile prevailing visibility or 1,200 feet RVR. **(T-0)**. **Note:** NA for "Copter" Procedures.

4.15.2. For a straight-in or sidestep approach, the forecast weather must meet required visibility minimums. **(T-1)**.

4.15.3. For a circling approach, the forecast weather must meet both the ceiling and prevailing visibility minimums. **(T-1)**.

4.15.4. (**Added-AFMC**) Refer to AFMAN 11-2FTV3 for MDS-specific weather requirements.

4.15.5. (**Added-AFMC**) Military Authority Assumes Responsibility for Separation of Aircraft (MARSA). The FOA may obtain letters of agreement for special IFR operations according to the MARSA concept. See FLIP GP for further guidance. PIC is not authorized to arbitrarily declare MARSA. **(T-2)**.

**4.16. IFR Alternate.** File an alternate airfield when:

4.16.1. A compatible instrument approach procedure is not available at the destination airfield. **(T-0)**. [14 CFR Part 91.169]; or,

4.16.2. Weather forecasts indicate, from 1 hour before to 1 hour after the estimated time of arrival at the destination airfield, including TEMPO conditions, are less than indicated below.



**Note:** Alternate requirement may be cancelled enroute if weather conditions improve at destination to exceed these requirements:

4.16.2.1. A ceiling of 2,000 feet above the airfield elevation and a visibility of 3 statute miles [14 CFR Part 91.169]. **(T-0)**.

4.16.2.2. [Helicopter only] A ceiling of 1,000 feet (or 400 feet above the lowest compatible approach minimums, whichever is higher) and a visibility of 2 statute miles [14 CFR Part 91.169]. **(T-0)**.

4.16.2.3. Forecast crosswinds are outside aircraft limitations. **(T-3)**.

4.16.3. MAJCOMs may authorize holding for a specified time in lieu of filing an alternate airfield for isolated destinations. MAJCOMs will define isolated destinations and prescribe weather criteria, fuel, and recovery procedures. The PIC will determine a point of no return that is the last possible diversion point to an enroute divert airfield **(T-2)**.

4.16.3. **(AFMC)** Aircraft may hold at a remote or island destination, instead of designating an alternate airport, if all of the following conditions are met. There must be enough fuel on board, in addition to required reserves, to hold for at least 1 hour after arriving at the initial approach fix. From 1 hour before until 2 hours after estimated time of arrival, the worst weather is forecast to be at or above that required for an airport to qualify as an alternate. The forecast crosswind component corrected for runway condition reading (RCR) is within the recommended zone of the aircraft's landing crosswind chart.

4.16.4. For selection of an alternate: Do not depart IFR unless the prevailing weather at the alternate, from 1 hour before to 1 hour after the estimated time of arrival, including TEMPO conditions (except those caused by thunderstorms, rain showers, or snow showers), is forecast to be at or above:

4.16.4.1. A ceiling of 1000 feet, or 500 feet above the lowest compatible approach minimums, whichever is higher; and a visibility of 2 statute miles or 1 statute mile above the lowest compatible approach minimums, whichever is higher. **(T-1)**.

4.16.4.2. [Helicopter only] A ceiling of at least 200 feet above, and a visibility of at least 1 statute mile above the lowest compatible approach minimums [14 CFR Part 91.169]. **(T-0)**.

4.16.4.3. If there is not a compatible instrument procedure published or available at the alternate, the weather forecast, from 1 hour before to 1 hour after the estimated time of arrival, including TEMPO conditions, must permit a descent from the minimum enroute altitude, approach and landing under basic VFR [14 CFR Part 91.169]. **(T-0)**. **Note:** **Paragraph 4.16.5** does not apply when utilizing this option.

4.16.4.4. Refer to **paragraph 4.17** when planning to use a GNSS-based approach at an alternate.

4.16.5. Do not select an airport as an alternate if any of the conditions below exist. **Note:** Conditions below are listed throughout multiple sources (e.g., terminal procedures publication, NOTAMs, IFR Supplement).

4.16.5.1. All compatible approaches require an unmonitored NAVAID. **(T-1)**; or,

4.16.5.2. The airfield does not report weather observations. **(T-1)**; or,

4.16.5.3. Alternate not authorized (▲ NA) on all compatible approaches. (T-1); or,

4.16.5.4. Any note disqualifying the airfield or all compatible approaches in the “▲ IFR Alternate Minimums” section. (T-1).

**4.17. PBN Alternate Airfield Considerations.** [AC 90-108; AIM 1-1-17] For flight planning purposes, any required alternate airfield must have an available instrument approach procedure that does not require the use of GNSS. (T-2). This restriction includes conducting a conventional approach at the alternate airfield using GNSS as a substitute means of navigation (e.g., using GNSS equipment as a substitute means of navigation for an out-of-service VOR on an ILS missed approach procedure). **Note:** This restriction does not apply to technical standard order (TSO)-C145 or TSO-C146 SBAS receivers, or receivers capable of fault detection and exclusion (FDE) capability in accordance with **Paragraph 4.17.1.**

**4.17.1. Non SBAS-Equipped Aircraft (including TSO-129 and TSO-196 receivers).** [AIM 1-2-3] For flight planning purposes, properly equipped GNSS users whose navigation systems have FDE capability, who perform a preflight RAIM prediction at the airfield where the RNAV (GPS) or RNAV (GNSS) approach is planned, have proper knowledge, required training, and approval to conduct a GNSS-based instrument approach, may file based on a GNSS-based instrument approach at either the destination or the alternate airfield, but not at both locations. At the alternate airfield, pilots may plan for:

4.17.1.1. Lateral Navigation (LNAV) or circling MDA;

4.17.1.2. LNAV/VNAV decision attitude (DA), if equipped with and using approved Barometric Vertical Navigation (Baro-VNAV) equipment; or

4.17.1.3. RNP 0.3 DA on an RNAV (RNP) instrument approach, if they are specifically authorized users with MAJCOM operational approval and approved Baro-VNAV equipment and the pilot has verified RNP availability through an approved prediction program.

4.17.1.4. If the above conditions cannot be met, any required alternate airfield must have an approved instrument approach procedure other than GNSS-based that is anticipated to be operational and available at the estimated time of arrival, and for which the aircraft is equipped to fly. (T-2).

**4.17.2. SBAS-Equipped Aircraft (including TSO-C145 and TSO-C146 receivers).** [AIM 1-1-18] Pilots with SBAS receivers may plan to use any instrument approach procedure authorized for use with their SBAS avionics as the planned approach at a required alternate, with the following restrictions:

4.17.2.1. When using SBAS at an alternate airfield, flight planning must be based on flying the LNAV or circling line of minima on a GPS approach procedure or a conventional approach procedure with “or GPS” in the title. (T-2).

4.17.2.2. Non-precision weather requirements must be used for planning. (T-2). **Note:** Properly trained and approved, as required, TSO-C145 and TSO-C146 equipped SBAS users using approved Baro-VNAV equipment may plan for LNAV/VNAV DA at an alternate airfield. Specifically authorized SBAS users using approved Baro-VNAV equipment may also plan for RNP 0.3 DA at the alternate airfield as long as the pilot has verified RNP availability through an approved prediction program.

4.17.2.3. Upon arrival at an alternate airfield, when the SBAS navigation system indicates that LNAV/VNAV or localizer performance with vertical guidance (LPV) service is available, then vertical guidance may be used to complete the approach using the displayed level of service.

**4.18. IFR Alternate Minimums.** [DoD Publication Product Specifications] Some civil and foreign approaches may have alternate minimums (**Figure 4.1**) or alternate not authorized (NA) (**Figure 4.2**) in the remarks.

4.18.1. The alternate minimums symbol informs pilots that the alternate weather minimums for an airfield are non-standard. Air Force pilots are not required to comply with the weather minimums listed in the IFR ALTERNATE MINIMUMS section of the Terminal Procedures Publication. **Note:** There may be other requirements that do apply to Air Force pilots. Therefore, pilots must review the IFR ALTERNATE MINIMUMS for pertinent information (e.g., “NA when local weather not available”, “NA when control tower closed”). **(T-0)**.

**Figure 4.1. IFR Alternate Minimums Symbol.**



4.18.2. The alternate NA symbol informs pilots that the specific approach cannot be used to qualify the field as an alternate due to an unmonitored NAVAID or the lack of a weather reporting service.

**Figure 4.2. Alternate Not Authorized Symbol.**



**4.19. VFR Flight.** Do not operate under VFR when unable to maintain the flight visibility or cloud clearances listed in **Table 12.1** or **Table 12.2** [14 CFR Part 91.155]. **(T-0)**.

4.19.1. Do not operate under VFR within the lateral boundaries of controlled airspace designated to the surface for an airport when the ceiling is less than 1,000 feet. **(T-0)**. **Exception: Paragraph 4.19.4.**

4.19.2. When conditions (e.g., weather, airspace) prevent completing the mission under VFR, alter route to maintain VFR, obtain an IFR clearance, or land at a suitable location. **(T-0)**.

4.19.3. When conducting tactical operations, fly under VFR unless compliance with VFR degrades mission accomplishment. **(T-3)**.

4.19.4. [Helicopter only] MAJCOMs may authorize helicopter special VFR (SVFR) operations in accordance with 14 CFR Part 91.157 or applicable host nation guidance. Reference **paragraph 4.43**.

4.19.4. (AFMC) Special VFR (SVFR). Helicopter aircrews, including tilt-rotor when operating in helicopter mode, are authorized to fly under SVFR, where applicable, when the weather is below that required for given airspace but above MDS-specific weather requirements.

4.19.5. VFR flight plans are not automatically closed upon landing. Pilots must ensure a VFR flight plan is closed to prevent unnecessary search and rescue operations. [AIM 5-1-14] **(T-0)**.

**4.20. Fuel Requirements.** The PIC will ensure sufficient fuel is available onboard the aircraft to safely conduct the flight. **(T-0)**.

4.20.1. Before takeoff or immediately after in-flight refueling, the aircraft must have enough usable fuel to complete the flight:

4.20.1.1. To a final landing, either at the destination airport or alternate airport (if required), plus fuel reserves **(T-0)**; or,

4.20.1.2. Between air refueling control points and then to land at the destination (or a recovery base, if refueling is not successful), plus fuel reserves **(T-2)**.

4.20.2. When an alternate airport is required, fuel required for an approach and missed approach at the intended destination must be included in the total flight plan fuel if visibility-only weather criteria is used at the destination. **(T-1)**. Fuel required for a missed approach is not required if both ceiling and visibility criteria are used. **(T-1)**.

4.20.3. Ensure the aircraft is carrying enough usable fuel on each flight to increase the total planned flight time between refueling points by 10 percent (up to a maximum of 45 minutes for fixed-wing or 30 minutes for helicopters) or 20 minutes, whichever is greater. **(T-1)**. Compute fuel reserves using MAJCOM-defined fuel consumption rates for normal cruising speeds or the following:

4.20.3. **(AFMC)** Refer to AFMAN 11-2FTV3 for additional fuel requirements.

4.20.3.1. For turbine-powered aircraft use fuel consumption rates that provide best endurance at 10,000 feet. MSL **(T-2)**.

4.20.3.2. For reciprocating engine aircraft and helicopters, use fuel consumption rates for normal cruising altitudes. **(T-2)**.

4.20.3.3. If the MAJCOM authorizes holding (instead of an alternate airport) for a remote or island destination, do not consider the prescribed holding time as part of the total planned flight time or fuel reserves **(T-2)**.

4.20.3.3. **(AFMC)** Aircraft may hold at a remote or island destination, instead of designating an alternate airport, if all of the following conditions are met. There must be enough fuel on board, in addition to required reserves, to hold for at least 1 hour after arriving at the initial approach fix.

4.20.4. In the absence of MDS-specific guidance, multi-engine aircraft without the ability to in-flight refuel, operating for extended periods over large bodies of water or desolate land areas shall calculate an Equal Time Point (ETP) to a suitable alternate for that mission leg. Contingency fuel requirements shall also be planned (e.g., engine-out depressurized flight from an ETP to a suitable landing site). **(T-2)**.

**4.21. Preflight Briefings.**

4.21.1. -[14 CFR Part 91.519] Prior to flight, ensure each aircrew member and passenger is briefed on items affecting safety or mission completion. **(T-0)**. At a minimum, briefings will include:

4.21.2. Emergency signals and procedures **(T-0)**;

4.21.3. Passenger flight equipment and systems usage information to include the location and use of emergency exits, parachutes, oxygen, communications systems, and survival equipment **(T-0)**; and,

4.21.4. Safety precautions and restrictions to include foreign object damage (FOD) hazards and electronic device prohibitions. **(T-1)**.

4.21.4. **(AFMC)** Crewmembers, maintenance engineering support personnel (MESP), mission essential personnel (MEP) and operational support fliers will not wear rings, scarves, pins, wigs, hair pieces, ornaments, barrettes, clips, earrings, and other hair fasteners made of leather, plastic, or metal while performing crew duties in or around the aircraft. **(T-2)**. Additionally, these items are prohibited for all occupants of ejection seat-equipped aircraft. **(T-2)**. Other items will be properly secured to minimize FOD risk. **(T-2)**. PICs will ensure that passengers wearing these items do not create a FOD hazard. **(T-2)**.

**4.22. Aircraft Category.** [ICAO Doc 8168 Volume 1] Aircraft approach category is equal to the stall speed ( $V_{so}$ ) multiplied by 1.3 or stall speed ( $V_{s1g}$ ) multiplied by 1.23 in the landing configuration at the maximum certificated landing mass. If both  $V_{so}$  and  $V_{s1g}$  are available, the higher resulting speed is used. **(Table 4.2)**. Use the minima corresponding to the category determined during aircraft certification or higher.

4.22.1. If it is necessary to maneuver at a speed exceeding the upper limit of the speed range for an aircraft category, pilots must use the minimums for the higher category unless otherwise authorized by AFI or MAJCOM directive. **(T-2)**. MAJCOMs will publish procedures to ensure that aircraft do not exceed protected airspace if allowing aircraft to fly an instrument approach using a lower category.

4.22.1. **(AFMC)** Pilots shall use the approach minimums associated with the aircraft category speed range being flown. **(T-2)**.

4.22.2. ICAO Procedures for Air Navigations Services-Aircraft Operations (PANS-OPS) criteria establish maximum speeds by aircraft category for departures **(Chapter 5)**, holding **(Chapter 13)**, circling **(Chapter 18)**, and all approach segments; refer to the appropriate chapter for these maximum speeds.

**Table 4.2. Aircraft Category.**

| Category                                       | Speed Range in Knots Indicated Airspeed |
|--|---|
| A  | Less than 91 knots                      |
| B  | 91 knots – 120 knots                    |
| C  | 121 knots – 140 knots                   |
| D  | 141 knots – 165 knots                   |
| E  | 166 knots or more                       |
| H  | Helicopters                             |
| <b>Note:</b> Helicopters may use CAT A minima. |   |

**4.23. Automation Management.** Pilots should be proficient at operating all levels of automation available on the aircraft. The level of automation used at any time should be that most appropriate for the circumstances to enhance safety and passenger comfort.

4.23.1. The lowest level of automation (i.e., “hand flying”) may be necessary until an inflight situation is resolved when an immediate change of aircraft path is required (e.g., escape or avoidance maneuvers, unusual attitude recovery). Regaining aircraft control should never be delayed to maintain a specific level of automation.

4.23.2. Proper execution of flight guidance panel inputs should be verified by checking that the resulting flight mode annunciations correctly correspond to the commanded inputs. Pilots should continually scan control, performance, and navigation instruments to ensure that the aircraft performs as expected in all modes of flight.

**4.24. Transitioning Airspace Classes.** When operating under IFR, transition from one type of airspace to another is generally transparent to the pilot. The IFR clearance is clearance to enter each type of airspace as it is encountered. Typically, specific clearances are not issued.

4.24.1. When operating under VFR, it is up to the pilot to determine the airspace type, operating rules, equipment requirements, and comply accordingly. Under VFR, transitions from one type of airspace to another are not transparent to the pilot, and in some cases, require a specific clearance.

4.24.2. [AIM 3-2-4] Two-way radio contact means the pilot is talking to ATC but may or may not have a clearance. An aircraft is considered in two-way radio contact if a controller responds to a radio call with, “[call sign] standby.” **Note:** If a controller responds with “Aircraft calling approach, standby” then two-way radio contact has not been established.

**4.25. VFR Flight in Controlled Airspace.** [AIM 3-2] In the NAS, ATC provides traffic advisories to all aircraft as the controller’s work situation permits. Safety alerts (terrain, obstruction, aircraft conflict, Mode C intruder) are mandatory services and provided to all aircraft.

**4.26. IFR Flight in Uncontrolled Airspace.** [ICAO Annex 11; AIM 3-3-3] IFR operations are permitted in uncontrolled airspace. All normal IFR equipment requirements and rules apply to include minimum altitude and flight level. While operating in VMC, pilots are solely responsible to see and avoid other traffic, terrain, and obstacles. ATC only provides separation between aircraft in controlled airspace. Therefore, caution should be exercised when operating in IMC under IFR in uncontrolled airspace.

**4.27. Airspace and Airspace Classification.** [AIM Chapter 3; ICAO Annex 11; FAA-H-8083-15, Chapter 1] Pilots should be familiar with the operational requirements for the airspace in which they operate (**Figure 4.3** and **Figure 4.4**). **Note:** Failure of equipment required for a specific airspace may render the aircraft unable to remain in that airspace.



Figure 4.3. NAS Airspace Classification.

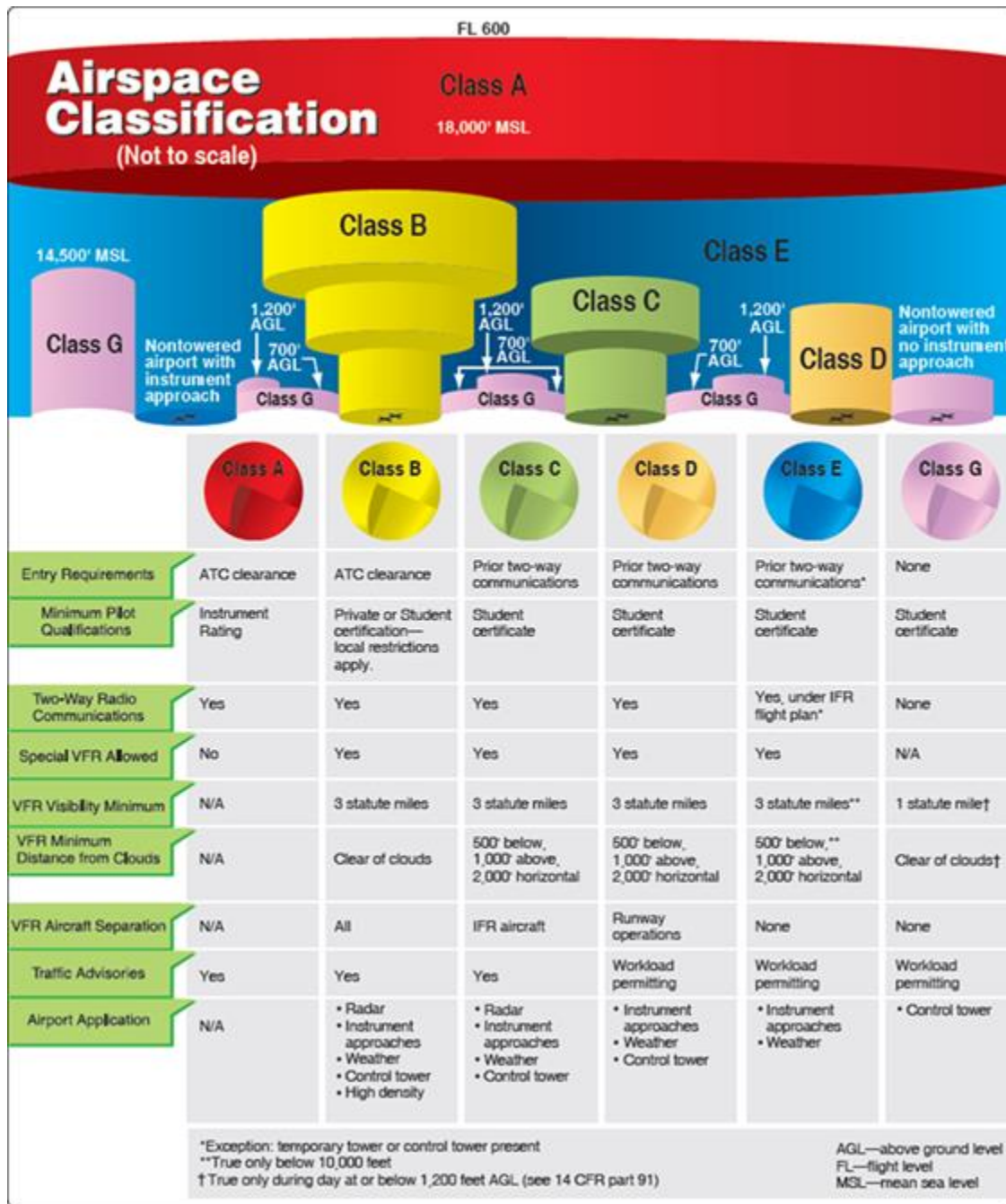


Figure 4.4. ICAO Airspace Classification.

| Class | Type of flight | Separation provided              | Service provided  | Speed limitation*                            | Radio communication requirement | Subject to an ATC clearance |
|-------|----------------|----------------------------------|---|--|---------------------------------|-----------------------------|
| A     | IFR only       | All aircraft                     | Air traffic control service   | Not applicable                               | Continuous two-way              | Yes                         |
| B     | IFR            | All aircraft                     | Air traffic control service   | Not applicable                               | Continuous two-way              | Yes                         |
|       | VFR            | All aircraft                     | Air traffic control service   | Not applicable                               | Continuous two-way              | Yes                         |
| C     | IFR            | IFR from IFR<br>IFR from VFR     | Air traffic control service   | Not applicable                               | Continuous two-way              | Yes                         |
|       | VFR            | VFR from IFR                     | 1) Air traffic control service for separation from IFR;<br>2) VFR/VFR traffic information (and traffic avoidance advice on request) | 250 kt IAS below<br>3 050 m (10 000 ft) AMSL | Continuous two-way              | Yes                         |
| D     | IFR            | IFR from IFR                     | Air traffic control service, traffic information about VFR flights (and traffic avoidance advice on request)                        | 250 kt IAS below<br>3 050 m (10 000 ft) AMSL | Continuous two-way              | Yes                         |
|       | VFR            | Nil                              | IFR/VFR and VFR/VFR traffic information (and traffic avoidance advice on request)   | 250 kt IAS below<br>3 050 m (10 000 ft) AMSL | Continuous two-way              | Yes                         |
| E     | IFR            | IFR from IFR                     | Air traffic control service and, as far as practical, traffic information about VFR flights   | 250 kt IAS below<br>3 050 m (10 000 ft) AMSL | Continuous two-way              | Yes                         |
|       | VFR            | Nil                              | Traffic information as far as practical   | 250 kt IAS below<br>3 050 m (10 000 ft) AMSL | No                              | No                          |
| F     | IFR            | IFR from IFR as far as practical | Air traffic advisory service; flight information service  | 250 kt IAS below<br>3 050 m (10 000 ft) AMSL | Continuous two-way              | No                          |
|       | VFR            | Nil                              | Flight information service  | 250 kt IAS below<br>3 050 m (10 000 ft) AMSL | No                              | No                          |
| G     | IFR            | Nil                              | Flight information service  | 250 kt IAS below<br>3 050 m (10 000 ft) AMSL | Continuous two-way              | No                          |
|       | VFR            | Nil                              | Flight information service  | 250 kt IAS below<br>3 050 m (10 000 ft) AMSL | No                              | No                          |

\* When the height of the transition altitude is lower than 3 050 m (10 000 ft) AMSL, FL 100 should be used in lieu of 10 000 ft.

4.27.1. Pilots will apply the operating rules associated with the more restrictive airspace designation when overlapping airspace designations exist. **(T-0)**.

4.27.2. Pilots will not plan to transit airspace without the required minimum equipment unless authorized by ATC. **(T-0)**.

4.27.3. [FAA JO 7110.65; FAA Pilot/Controller Glossary] In a non-radar environment, ATC does not have a radio detection device to provide information on range, azimuth and elevation of objects. ATC relies on information relayed from flight crews to determine the actual geographic position and altitude (e.g., voice position reports, data link). **Note:** Aircraft in controlled airspace can be in a non-radar environment.



- 4.27.4. Radar service may be provided in a radar environment. **Note:** An aircraft can be VFR and not in two-way radio contact with ATC and still be operating in a radar environment.
- 4.27.5. Controlled airspace is a generic term that covers the different classifications of airspace (Classes A through E) and defined dimensions within which ATC service is provided in accordance with the airspace classification.
- 4.27.6. Uncontrolled airspace is a term that covers all airspace (Classes F through G) not designated as controlled airspace. **Note:** Class F airspace is not used in the NAS.
- 4.27.7. Prohibited areas are airspace of defined dimensions, above the land areas or territorial waters of a State, within which aircraft flight is prohibited [ICAO Annex 2; AIM 3-4-2].
- 4.27.8. Restricted areas are airspace of defined dimensions, above the land areas or territorial waters of a State, within which aircraft flight is restricted in accordance with certain specified conditions [ICAO Annex 2; AIM 3-4-3].
- 4.27.9. Danger areas or **(NAS Only)** warning areas are airspace of defined dimensions within which activities dangerous to aircraft flight may exist at specified times [ICAO Annex 2].
- 4.27.10. [AIM 3-4] **(NAS Only)** Special use airspace includes prohibited, restricted, and warning areas. **Note:** Prohibited and restricted areas are regulatory special use airspace; military operations areas, warning areas, controlled firing areas, and national security areas (NSA) are non-regulatory special use airspace.
- 4.27.11. **[NAS Only]** The FAA may impose TFRs for many reasons (e.g., imminent hazards, disaster relief) [14 CFR Part 91; AIM 3-5-3]. The current list of TFRs may be found at <http://tfr.faa.gov/>.
- 4.27.12. **[NAS Only]** MTRs allow the military to train in a wide range of airborne tactics. MTRs may be either IFR MTRs (IR) or VFR MTRs (VR) [AIM 3-5-2; FLIP AP/1B].
- 4.27.12.1. [FLIP AP/1B] Unlike IRs and VRs, SRs are not part of the MTR system and therefore have no directive guidance in the AIM or FAA Order JO 7610.4, *Special Operations*.
- 4.27.12.2. Slow Routes are low-level routes at or below 1,500 feet above ground level (AGL) and are published in AP/1B. Flight above 1,500 feet AGL does not meet the criteria of the SR system.
- 4.27.13. **[NAS Only]** Tabulations of parachute jump areas in the United States are contained in the *Chart Supplement U.S.* [AIM 3-5-4].
- 4.27.14. [AIM 5-6] The ADIZ is special designated airspace of defined dimensions within which aircraft are required to comply with special identification and reporting procedures additional to those related to ATS provisions. **Note:** Pilots will adhere to ADIZ procedures unless approved for a specific mission exception. **(T-0)**.
- 4.27.15. **[NAS Only]** Certain areas are prescribed special air traffic rules areas and pilots must adhere to Title 14, Code of Federal Regulations, Part 93, Special Air Traffic Rules, Current Edition, unless otherwise authorized by ATC [AIM 3-5-7; 14 CFR Part 93; FAA JO 7210.3]. **(T-0)**.

**4.28. Reduced Vertical Separation Minimum (RVSM).** [14 CFR Part 91 Appendix G, ICAO Doc 4444] Within RVSM airspace, ATC separates aircraft by a minimum of 1,000 feet vertically between FL290 and FL410 inclusive. RVSM airspace is special certification airspace; MAJCOMs will ensure aircrew are trained, aircraft are certified, and are granted operational approval for RVSM airspace. **Note:** Formation flights are non-RVSM if any aircraft in the formation is non-RVSM.

**4.28. (AFMC) Reduced Vertical Separation Minimum (RVSM).** Refer to AFMC/A3V SharePoint for the current MDS specific CNS/ATM certifications.

**4.29. Procedures for Accommodation of Non-RVSM Aircraft in RVSM Airspace.** [AIM 4-6-10; 14 CFR Part 91.180; 14 CFR Part 91 Appendix G, ICAO Doc 4444] If the aircraft is not certified and operationally approved for RVSM operations, the aircraft is referred to as a “non-RVSM” aircraft. **Note:** Failure of equipment required for RVSM airspace may make an aircraft non-RVSM.

4.29.1. Non-RVSM aircraft are handled on a workload permitting basis. The vertical separation standard applied between non-RVSM aircraft and all other aircraft is 2,000 feet.

4.29.2. Pilots will inform controllers of the lack of RVSM approval. **(T-0).**

4.29.3. The transponder must be operational to fly in RVSM airspace. **(T-0).**

4.29.4. - [AIM 4-6-11] Aircraft requesting a climb to and descent from FL above RVSM airspace without intermediate level off must:

4.29.4.1. Be capable of a continuous climb or descent and not need to level off at an intermediate altitude for any operational consideration **(T-0)**; and

4.29.4.2. Be capable of climbing and descending at the normal rate for the aircraft. **(T-0).**

**4.30. Level Off Operating Practices.** Operational experience, monitoring studies, and pilot or controller reports have shown incompatibilities between TCAS and ATC systems.

4.30.1. When safe, practical, and in accordance with aircraft flight manual operating procedures, pilots should limit vertical speed to 1,500 feet per minute or less when within 1,000 feet of assigned altitudes. This should reduce unnecessary RAs and is in line with AIM and ICAO guidance.

4.30.2. Aircraft leveling off at 1,000 feet above or below level conflicting traffic may result in RAs being issued to the level aircraft. These RAs are triggered because the climbing or descending aircraft maintains high vertical speeds when approaching the cleared altitude or flight level. The collision logic contains algorithms that recognize this encounter geometry and delays the issuance of a traffic advisory to the level aircraft by up to 5 seconds to allow TCAS to detect the initiation of the level off maneuver by the intruder.

**4.31. Air Traffic Services (ATS).** [ICAO Annex 11, Chapter 2]

4.31.1. ATC service is provided to prevent collisions between aircraft or between aircraft and obstructions within the maneuvering area, and expediting and maintaining an orderly flow of traffic; it is divided into three parts:

4.31.1.1. Area control service provides ATC services for controlled flights.

4.31.1.2. Approach control service provides ATC services for those parts of controlled flights associated with arrival or departure.

4.31.1.3. Aerodrome control service provides ATC services for airfield traffic except those under approach control service.

4.31.2. Flight information service provides advice and information useful for the safe and efficient conduct of flights.

4.31.3. Alerting service notifies appropriate organizations regarding aircraft in need of search and rescue aid and assist such organizations as required.

**4.32. Emergency Frequencies.** Emergency frequencies are 121.5 megahertz (MHz) and 243.0 MHz. These frequencies are to be used when not in radio contact with ATC and aircrew need to make emergency contact or to contact ATC when no other means are available.

**4.33. Flight Service Station (FSS).** [FAA Pilot/Controller Glossary] A FSS is an air traffic facility which provides preflight briefings, flight plan processing, enroute flight advisories, search and rescue services, and assistance to lost aircraft and aircraft in emergency situations. A FSS may also relay ATC clearances, process NOTAMS, broadcast aviation weather and aeronautical information, and advise U.S. Customs and Immigration of trans-border flights. In Alaska, a FSS may provide airfield advisory services.

4.33.1. -[FAA General Aviation Pilot's Guide to Preflight Weather Planning, Weather Self-Briefings, and Weather Decision Making] A FSS may be reached by phone at 1-800-WX-BRIEF or by radio on frequencies published on FAA sectionals and enroute charts. **Note:** When dialing the standard number, 1-800-WX-BRIEF from a cell phone, this number connects to the FSS associated with the cell phone area code, not necessarily the nearest FSS. If using a cell phone outside its calling area, check the *Chart Supplement U.S.* to find the specific telephone number for the nearest FSS.

4.33.2. -[FAA JO 7110.10, *Flight Services*; FAA Pilot/Controller Glossary] An FSS may be equipped with remote communication outlets and can transmit and receive on more than one frequency at more than one location. Broadcast "any radio" with aircraft call sign and the nearest NAVAID to ensure FSS personnel use the correct transmitter.

**4.34. Local Airport Advisory.** [AIM 3-5-1] Local airport advisory service is available only in Alaska and is operated within 10 statute miles of an airfield where an FSS is at the airfield.

4.34.1. The FSS automatically provides "final guard" during periods of fast-changing weather as part of the service from the time the aircraft reports "on final" or "taking the active runway" until the aircraft reports "on the ground" or "airborne".

4.34.2. "Final guard" is a value-added wind and altimeter monitoring service which provides an automatic wind and altimeter check during active weather situations when the pilot reports "on final" or "taking the active runway".

**4.35. Remote Airport Information Service.** [AIM 3-5-1] Remote airport information service is provided in support of short-term special events like small to medium fly-ins. The service is advertised by "D" NOTAM only from the NTAP.

**4.36. VFR Radar Assistance.** [FAA JO 7110.10] ATC may provide vectoring services to VFR aircraft. ATC may have limited vectoring capability for weather avoidance, but the responsibility to remain in VMC rests with the pilot.

**4.37. VFR Flight Following.** [FAA JO 7110.10] Flight following services are provided if requested by the pilot and ATC workload and equipment capability permits. ATC should provide separation from IFR traffic and participating VFR traffic. The ultimate responsibility for traffic separation still rests with the pilot while participating in flight following.

**4.38. VFR Cruising Altitudes and Flight Levels.** [ICAO Annex 2, Chapter 4] Except where otherwise indicated in ATC clearances or specified by the appropriate ATS authority, VFR flights in level cruising flight operated above 3,000 feet AGL or higher as specified by the appropriate ATS authority will be conducted at a cruising level appropriate to the track as specified in **Table 4.3 (T-1)**.

**Table 4.3. VFR Cruising Altitudes and Flight Levels.**

| From 000 degrees to 179 degrees magnetic   |              | From 180 degrees to 359 degrees magnetic |              |
|--|--------------|--|--------------|
| Altitude (Feet)  | Flight Level | Altitude (Feet)                          | Flight Level |
| 3500   | FL035        | 4500                                     | FL045        |
| 5500   | FL055        | 6500                                     | FL065        |
| 7500   | FL075        | 8500                                     | FL085        |
| 9500   | FL095        | 10500                                    | FL105        |
| 11500  | FL115        | 12500                                    | FL125        |
| 13500  | FL135        | 14500                                    | FL145        |
| 15500  | FL155        | 16500                                    | FL165        |
| 17500  | FL175        | 18500                                    | FL185        |
| 19500  | FL195        | 20500                                    | FL205        |
| 21500  | FL215        | 22500                                    | FL225        |
| 23500  | FL235        | 24500                                    | FL245        |
| 25500  | FL255        | 26500                                    | FL265        |
| 27500  | FL275        | 28500                                    | FL285        |
| VFR Cruising Altitudes and Flight Levels (non-RVSM airspace only)  |              |  |              |
| 30000  | FL300        | 32000                                    | FL320        |
| 34000  | FL340        | 36000                                    | FL360        |
| 38000  | FL380        | 40000                                    | FL400        |
| <i>etc.</i>  | <i>etc.</i>  | <i>etc.</i>                              | <i>etc.</i>  |
| <b>Notes:</b>  |              |  |              |
| 1) VFR flights will not be operated above FL200 or at transonic and supersonic speeds unless authorized by the appropriate ATS authority [ICAO Annex 2, Chapter 4]. <b>(T-1)</b> . |              |  |              |
| 2) <b>(NAS Only)</b> Pilots will maintain the altitude or flight level assigned by ATC when operating VFR above 18,000 MSL [14 CFR Part 91.159]. <b>(T-0)</b> .                    |              |  |              |

**4.39. Composite Flight Plan (IFR/VFR Flights).** [AIM 5-1-7] Procedures for filing a composite flight plan are in FLIP General Planning Chapter 4.

4.39.1. Prior to transitioning to the IFR segment, maintain VMC and contact the nearest FSS and request an IFR clearance. Once cleared by ATC to operate IFR, either request ATC “close

VFR flight plan” or cancel the VFR portion with an FSS. Ensure the VFR flight plan is closed to prevent unnecessary search and rescue operations.

4.39.2. Cancel IFR with ATC and contact an FSS to activate the VFR portion of the flight plan.

**4.40. [ICAO] Transitioning IFR to VFR.** [ICAO Doc 4444] Pilots must specifically request “cancelling my IFR flight” and any changes to the current flight plan. **(T-1)**. ATC should respond with “IFR flight cancelled at (time)”.

**4.41. VFR Helicopter Operations.** Helicopters should avoid the flow of fixed wing aircraft traffic patterns, unless able to maintain a compatible speed.

**4.42. VFR-on-top.** [AIM 4-4-8] A pilot on an IFR flight plan in VMC may request VFR-on-top in lieu of an assigned altitude. This permits a pilot to select an altitude or FL of their choice (subject to ATC restriction). When operating in VMC with ATC authorization to “maintain VFR-on-top, maintain VFR conditions” pilots must:

4.42.1. Fly at the appropriate VFR altitude. **(T-0)**.

4.42.2. Comply with VFR visibility and distance from cloud criteria. **(T-0)**.

4.42.3. Comply with IFR as applicable to the flight (e.g., minimum IFR altitudes, radio communications, course to be flown, adherence to ATC clearances). **(T-0)**.

**4.43. Special VFR.** [ICAO Doc 4444, Chapter 7; AIM 4-4-6] Special VFR allow aircraft to operate under VFR when meteorological conditions are less than those required for VFR flight in Class B, C, D, or E airspace. Helicopters may request SVFR, where applicable, when the weather is below that required for the given airspace but above MDS-specific weather requirements.

**4.44. Defense VFR (DVFR).** [14 CFR Part 99, Current Edition; AIM 5-6-4] Allows aircraft to operate under VFR in the ADIZ.

4.44.1. Two-way radio communications must be maintained and aircraft must have an operable transponder unless specifically cleared by ATC. **(T-0)**.

4.44.2. If unable to maintain two-way radio communication, the pilot may proceed in accordance with the original DVFR flight plan or land as soon as practicable. The pilot must report radio failure to an appropriate aeronautical facility as soon as possible. **(T-0)**.

4.44.3. DVFR flight plans must contain the time and point of ADIZ penetration and the aircraft must depart within five minutes of the estimated departure time. **(T-0)**.

4.44.4. No pilot may deviate from an ATC clearance or the filed DVFR flight plan unless that pilot notifies an appropriate aeronautical facility before deviating. **(T-0)**.

4.44.5. In controlled airspace, pilots must make the required position report. **(T-0)**.

4.44.6. In uncontrolled airspace, pilots must:

4.44.6.1. Report the time, position, and altitude at which the aircraft passed the last reporting point before entering the ADIZ and the ETA over the next appropriate reporting point along the route. **(T-0)**.

4.44.6.2. If there is not an appropriate reporting point along the route, the pilot reports at least 15 minutes before entering the ADIZ, the estimated time, position and altitude at which the aircraft will enter the ADIZ. **(T-0)**.

4.44.6.3. If the departure airfield is within ADIZ or so close to the ADIZ boundary that it prevents the pilot from complying with the previous paragraphs, then the pilot must report immediately after departure, the time of departure, the altitude, and the ETA over the first reporting point along the route. **(T-0)**.

**4.45. Inadvertent Flight into IMC While Operating Under VFR.** Anticipate IMC and alter route of flight to maintain VMC unless safety dictates otherwise. If unable to maintain VMC, immediately transition to instruments, coordinate an IFR clearance, and cancel the VFR flight plan.

**4.46. [NAS Only] Declared Distances.** [AIM 4-3-6] Declared distances are marked on instrument approach plates (IAP) or airfield diagrams with an “inverse D” symbol (**Figure 4.5**). Declared distances for a runway represent the maximum distances available and suitable for meeting takeoff and landing distance performance requirements (**Figure 4.6** and **Figure 4.7**). These distances are determined in accordance with FAA runway design standards. A declared distance program has four defined distances:

4.46.1. Takeoff run available (TORA) is the runway length declared available and suitable for the ground run of an airplane taking off. The TORA is typically the physical length of the runway, but it may be shorter than the runway length if necessary to satisfy runway design standards.

4.46.2. Takeoff distance available (TODA) is the takeoff run available plus the length of any remaining runway or clearway beyond the far end of the takeoff run available. The TODA is the distance declared available for satisfying takeoff distance requirements for aircraft where certification, operating rules, and available performance data allow for the consideration of a clearway in takeoff performance calculations. **Note:** Pilots will not use TODA for takeoff performance calculations without specific MAJCOM authorization and training. **(T-1)**.

4.46.3. Accelerate-stop distance available (ASDA) is the runway plus stopway length declared available and suitable for the acceleration and deceleration of an airplane aborting a takeoff. The ASDA may be longer than the physical length of the runway when a stopway has been designated available by the airfield operator, or it may be shorter than the physical length of the runway if necessary to use a portion of the runway to satisfy runway design standards.

4.46.4. Landing distance available (LDA) is the runway length declared available and suitable for a landing airplane. The LDA may be less than the physical length of the runway or the length of the runway remaining beyond a displaced threshold if necessary to satisfy runway design standards; for example, where the airfield operator uses a portion of the runway to achieve the runway safety area requirement.

**Figure 4.5. [NAS Only] Declared Distance Symbol.**



4.46.5. Operations are not bound by declared distances as long as the takeoff and landing performance calculations fall within the published distances. An aircraft is not prohibited from

operating beyond a declared distance during takeoff, landing, or taxi provided the runway surface is appropriately marked as usable.

4.46.6. Declared distances are not designed with consideration for touch-and-go operations. MAJCOMs will establish procedures that account for declared distances during touch-and-go operations.

4.46.6. (AFMC) Pilots conducting touch-and-go operations at an airfield with declared distances must be familiar with both the TODA and the LDA. Use the LDA to determine a runway remaining go-only decision point. **Note:** this calculated decision point is valid only if the aircraft speed is at or below charted touch-down speed at the go-only decision point. Make any rejected takeoff decision prior to this go-only point. After this point, the pilot is committed to take any emergency airborne else accept the aircraft may depart the prepared surface. (Example: LDA is 6,000 feet. Calculated aircraft stopping distance is 4,500 feet. Go-only decision point would be 4,500 feet short of the LDA end-point.)

Figure 4.6. [NAS Only] Declared Distances.

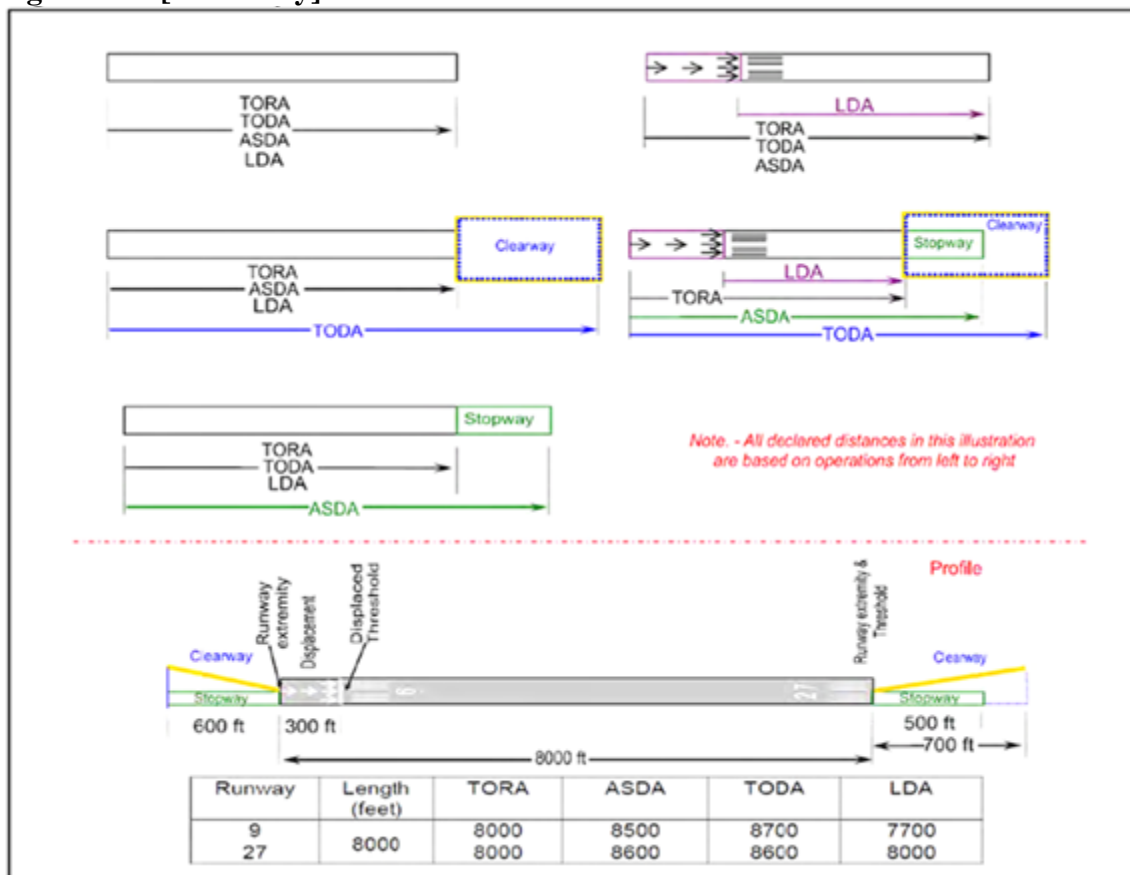
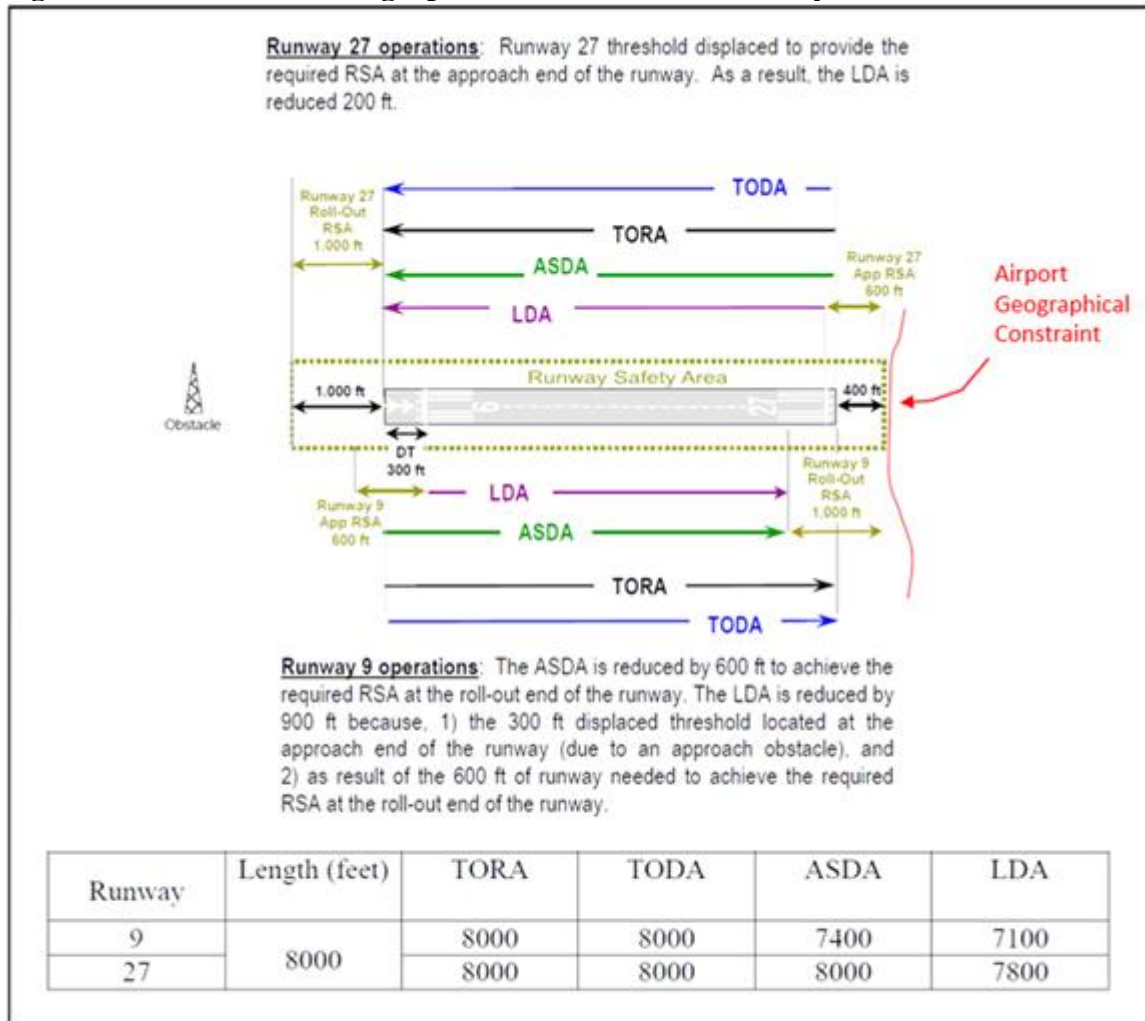




Figure 4.7. Effects of a Geographical Constraint on Runway Declared Distances.

**NOTE-**

A runway's RSA begins a set distance prior to the threshold and will extend a set distance beyond the end of the runway depending on the runway's design criteria. If these required lengths cannot be achieved, the ASDA and/or LDA will be reduced as necessary to obtain the required lengths to the extent practicable.

**4.47. Altimeter Settings.** [AIM 7-2; FAA-H-8083-16; ICAO Doc 8168 Volume 1] The units of measure for altimeter settings are hectopascals (hPa), millibars (mb), inches of mercury (in Hg), and millimeters of mercury (mm Hg). **Note:** Hectopascals and millibars may be used interchangeably.

4.47.1. Many sensitive altimeters can display two different barometric scales in the Kollsman window of the altimeter. Use the proper scale to set the altimeter setting. For aircraft that have only one type of altimeter scale, or for areas where the altimeter setting is not converted by aircraft systems, the FIH section D contains the appropriate conversion table.

4.47.2. In some areas, controllers use shorthand to issue an altimeter setting, which can cause confusion for crews. For example, "992" could mean "29.92 in Hg" or "992 mb". Always confirm the correct units of measure when setting the altimeter.



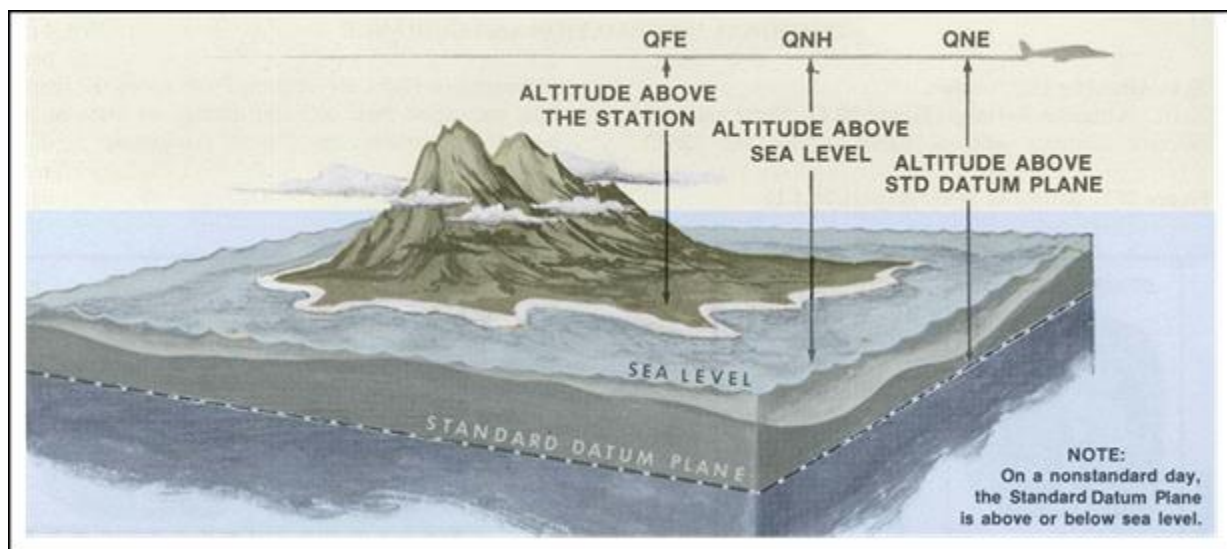
4.47.3. The types of altimeter settings are QNH, QNE, and QFE (**Figure 4.8**). Refer to ICAO State AIPs and the FLIP AP series for altimeter setting procedures and units used for each ICAO State from which a pilot operates. (**NAS Only**) QNH is used exclusively for altimeter settings.

4.47.4. QNH indicates aircraft height in MSL. **Note:** All DoD design criteria are based upon QNH altimeter settings but may provide QFE altitudes in parenthesis.

4.47.5. QNE indicates aircraft height above an imaginary plane called the “standard datum plane” (i.e., FL0). The altimeter setting at FL0 is 29.92 in Hg or 1013.25 mb.

4.47.6. QFE indicates aircraft height in AGL. The altimeter should indicate zero on the ground with the proper QFE set.

**Figure 4.8. Types of Altimeter Settings.**



4.47.7. Transition altitude (TA) is the altitude near an airfield at or below which the vertical position of an aircraft is determined from an altimeter set to QNH or QFE as appropriate. TA is normally specified for each airfield by the ICAO State in which the airfield exists. TA should not normally be below 3,000 feet height above airfield (HAA) and is published on the appropriate charts. **Note: (NAS Only)** The TA is always 18,000 feet.

4.47.8. Transition level (TLv) is the lowest FL available for use above the TA. TLv is usually passed to the aircraft during the approach or landing clearance. The TLv may be published or available via automatic terminal information service (ATIS). Half FLs may be used (e.g., FL45). **Note: (NAS Only)** The TLv is FL180 unless the QNH altimeter setting is less than 29.92 in Hg; refer to the FIH section B for further information.

4.47.9. The transition layer is that area between the TA and TLv. Aircraft are not normally assigned altitudes within the transition layer.

**4.48. Altimeter Use in Flight.** The vertical position of an aircraft at or below TA is expressed in altitude (QNH or QFE as appropriate). Vertical position at or above the TLv is expressed in terms of FL (QNE).

4.48.1. When passing through the transition layer, vertical position is expressed in terms of FL (QNE) when climbing and in terms of altitudes or height (QNH or QFE as appropriate) when descending.

4.48.2. After an approach clearance has been issued and the descent to land is commenced, the vertical positioning of an aircraft above the TLv may be by reference to altitude (QNH or QFE as appropriate) provided that level flight above the transition altitude is not indicated or anticipated. This is intended for turbo jet aircraft where an uninterrupted descent from high altitude is desired and for airfields equipped to reference altitudes throughout the descent.

4.48.3. Set QNE when climbing through or operating above the TA. Set the reported QNH or QFE, as appropriate, when descending through or operating below the TLv.

4.48.4. Pilots may be required to fly altitudes or FLs in meters and use an altimeter setting other than inches of mercury QNH. For example, altitude in meters, using a QFE altimeter setting in mbar. **Note:** Misapplication of conversions in these areas can cause a mid-air collision or collision with the ground.

4.48.5. When operating at non-towered or austere locations, use all means available to obtain a local altimeter setting prior to departure. Some non-towered airfields have automated weather reporting capability that includes altimeter setting.

4.48.5.1. At certain locations it may be possible to obtain a nearby altimeter setting. However, use caution as bodies of water, terrain, or meteorological phenomena can cause significant local differences in altimeter settings over a short distance.

4.48.5.2. If no other means are available to obtain a local altimeter setting, set the airfield elevation in the altimeter.

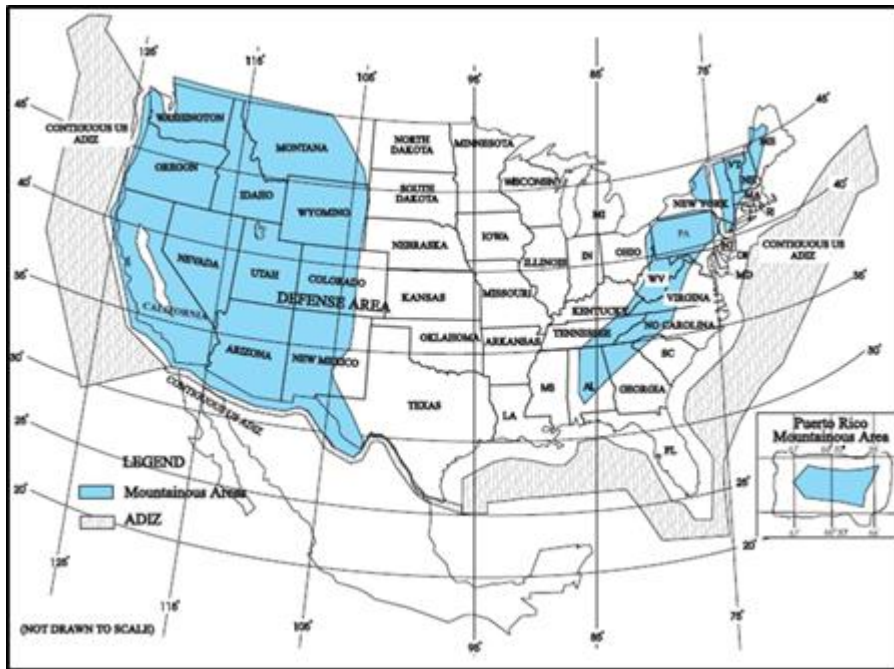
**4.49. Flight in Extreme Barometric Pressures.** [AIM 7-2-2] If unable to display proper altimeter setting (i.e., barometric pressure is lower than 28.00 or higher than 31.00 inches of mercury), refer to AIM for procedures. The Operations Group Commander is the approval authority to launch flight operations in areas with extreme barometric pressures.

**4.50. Flight in Colder Than International Standard Atmosphere (ISA) Temperatures.** Pressure altimeters are calibrated to indicate true altitude under ISA conditions. Any deviation from ISA results in an erroneous reading on the altimeter. The altimeter error becomes extremely important when considering obstacle clearances in temperatures lower than standard since the aircraft's true altitude is lower than the figure indicated by the altimeter. The error is proportional to the difference between actual and ISA temperature and the height of the aircraft above the altimeter setting source. Height above altimeter setting source is the altitude AGL at the airfield where the altimeter source is located. The amount of error is approximately 4 feet per thousand feet for each degree Celsius of difference from ISA.

4.50.1. [ICAO] Minimum vectoring altitudes include a correction for cold temperatures; refer to the applicable AIP for exceptions. Mountainous areas are defined as an area of changing terrain where the changes of terrain elevation exceed 3,000 feet within 10 nautical miles.

4.50.2. [NAS Only] Radar minimum vectoring altitudes are not corrected for cold temperatures. Mountainous areas are in accordance with 14 CFR Part 95.11, *IFR Altitude*, Current Edition ([Figure 4.9](#)).

Figure 4.9. NAS Designated Mountainous Areas.



**4.51. Cold Weather Altimeter Corrections.** [14 CFR Part 97, Cold Temperature Restricted Airports (CTRA), Current Edition; FAA Notices to Airmen, Cold Temperature Restricted Airports] The PIC shall apply cold weather temperature corrections in accordance with [Table 4.4](#) utilizing the temperature correction chart in the FIH and the following **(T-1)**:

4.51.1. When departing from an aerodrome with a temperature of 0° C or less, aircrew will temperature correct all altitudes (including the 400 feet. above departure end of runway (DER)) to a temperature corrected minimum safe altitude. **(T-1)**.

4.51.2. Do not apply a temperature correction to an ATC-assigned altitude. **(T-0)**. Radar vectoring altitudes assigned by ATC may or may not be temperature compensated and should be queried or refused if obstacle clearance is in doubt.

4.51.3. When flying over mountainous terrain when outside air temperature is colder than ISA minus 10° C, and aircraft unable to display true altitude, apply cold weather corrections to altitudes that are used to avoid terrain. **(T-1)**.

4.51.4. MAJCOMs may authorize the use of automated means (e.g., flight management system (FMS)-derived, EFB application, or other resources) to temperature correct altitudes. **Note:** Some FMS systems temperature compensate for hot temperatures, this feature should not be used.

4.51.5. Pilots must advise ATC of the corrected altitude when applying altitude corrections on any approach segment with the exception of the final segment. **(T-1)**.

4.51.6. Pilots must not make an altimeter change to accomplish an altitude correction. **(T-1)**.

**Table 4.4. Cold Weather Altitude Corrections.**

| Altimeter Setting Source Temperature  | Typical IAP  | IAP in Mountainous Terrain       | IAP has procedure turn or intermediate approach altitude $\geq 3,000$ ft above altimeter setting source |
|---|--|----------------------------------|---|
| At or Below 32°F/0°C  | Correct all altitudes inside FAF or below 1,000 feet AGL | Correct all altitudes on the IAP |   |
| At or Below - 22°F/-30°C  |  |                                  |   |
| At or Below Published Snowflake Temp ❄  |  |                                  |   |
| <i>Note: IAP includes minimum sector altitudes, missed approach altitudes, emergency safe altitude, minimum safe altitude, and distance measuring equipment arcs.</i> |  |                                  |   |

**Table 4.5. (Added-AFMC) Pilot Requirements and Restrictions.**

|             | A                              | B   | C   | D  | E  |
|-------------|--------------------------------|---|---|--|--|
| <b>RULE</b> | <b>If Aircraft Is</b>          | <b>And If</b>   | <b>Then Pilot(s)</b><br>(Note 1)          | <b>And</b>   | <b>Exceptions and Restrictions</b> (Note 2, Note 4, Note 5)  |
| <b>1</b>    | Cargo Tanker Bomber E-3 or E-8 | A passenger or individual on an orientation flight is onboard     | Must be a MP (MC for co-pilots) or higher | Other aircrew members must be qualified or monitored by instructor of the same specialty |  |
| <b>2</b>    | Cargo Tanker Bomber E-3 or E-8 | A VIP or Non-qualified person occupies a mandatory pilot position | In command must be an IP                  | Another qualified pilot must be onboard, and no passengers will be onboard               | 1. FOAs may authorize:<br>a. Non-pilots to occupy a pilot position only during non-critical phases of flight in day VMC.<br>b. Non-qualified pilots to occupy a pilot position during critical phases of |

|          |  |  |                          |  |   |
|----------|--|--|--------------------------|--|---|
|          |  |  |                          |  | <p>flight if the need is fully justified.</p> <p>c. A waiver to the requirement to have an additional pilot onboard on a case- by-case basis.</p> <p>d. TPS graduates or TPS students performing qualitative flying evaluations in conjunction with a TPS syllabus event or short term qualitative evaluations to occupy a pilot position during non-critical and specific critical phases of flight as defined in AFMAN 11- 2FTV3.</p> <p>2. Another qualified pilot is not required when the IP is training pilot(s), or when flight is part of a TPS syllabus or qual/eval flight IAW AFMAN 11- 2FTV1&amp;3.</p> |
| <b>3</b> | Fighter (Note 3)<br>Trainer (Note 3) or U- 2 | A non-qualified pilot occupies the mandatory pilot position or will perform takeoffs or landings from any position | In command must be an IP |  | FOAs may authorize non-qualified pilots to occupy the mandatory pilot position if the need is fully justified.  |
| <b>4</b> | Fighter (Note 3)<br>Trainer (Note 3) or U- 2 | A VIP or non-pilot on an orientation flight occupies a position with a set of flight controls                      | In command must be an IP |  | FOAs may authorize highly qualified MPs to fly non-VIP military personnel on orientation flights.   |

|   |              |  |                                   |  |   |
|---|--------------|--|-----------------------------------|--|---|
| 5 | All Aircraft | A MESP occupies a position with a set of flight controls                   | In command must be a MP or higher |  | MESPs must not occupy a mandatory pilot position (Note 3).  |
| 6 | Helicopters  | A person other than a qualified helicopter pilot occupies a pilot position | In command must be an IP          |  | The IP must perform all maneuvers during critical phases of flight and occupy the right seat pilot position except when training unqualified helicopter pilots or qual flight IAW AFMAN 11-2FTV1.<br>For UH-1, also refer to AFI 11-401, <b>paragraph 1.12.2.3.</b> |

**NOTES:**

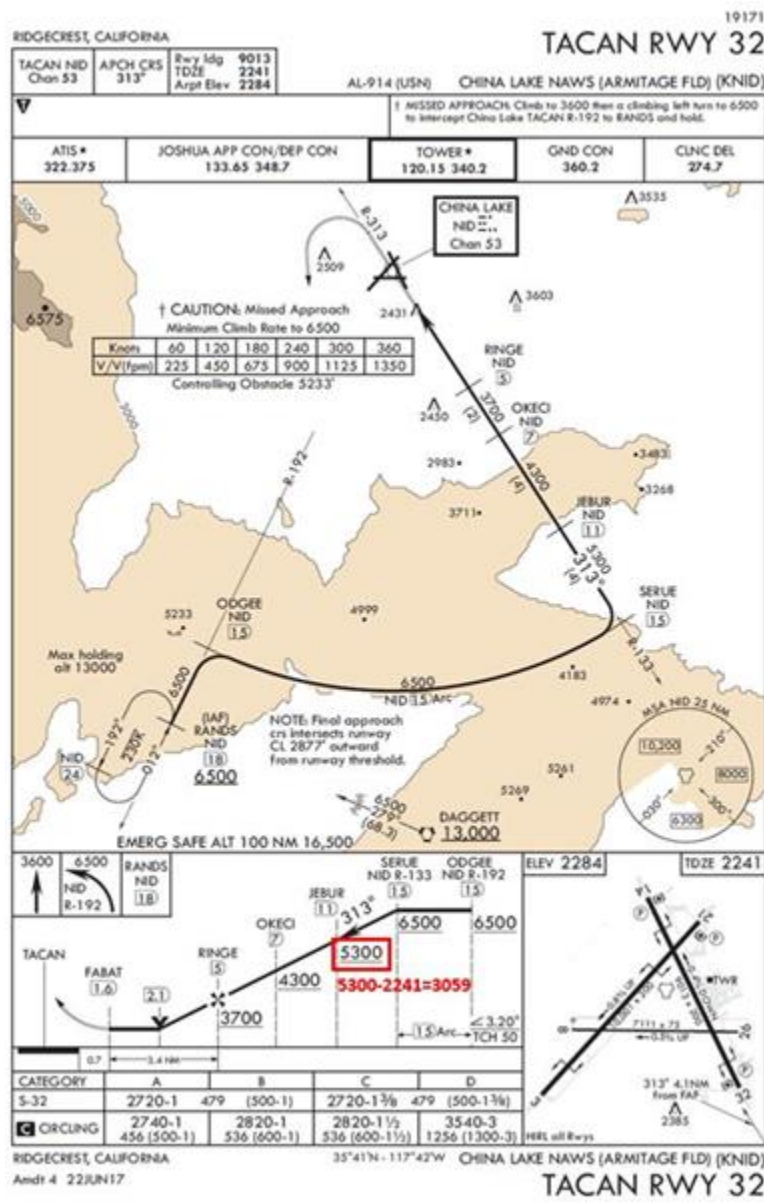
1. Pilots in this column must be current and qualified.
2. Document FOA authorizations/waivers in writing (method determined locally).
3. Dual cockpit fighters and trainers have only one mandatory pilot position, the front cockpit. Subject to the restrictions in AFI 11-401, Aviation Management, **paragraph 1.12.1**, and this **Table 4.1.**, specifically, FOAs may authorize non-pilots to occupy a non-mandatory crew position. Two seat fighters and T-38s are not considered dual controlled aircraft.
4. Use of Column B (occupying a mandatory pilot position during critical phases of flight) for AFTC personnel O-6/GS-15 and above is elevated to the AFTC/CC. AFMC/A3 is the approval authority for non-AFTC O-6/GS-15 **and above** personnel. These authorities cannot be further delegated nor are they to be confused with AFI 11-401 Orientation Flight approval authorities.
5. AFMC/A3V evaluators supporting A3V evaluations do not require FOA approval.

**4.52. Calculating Cold Temperature Corrections.** The table in the FIH is linear and allows for interpolation to determine the required altimeter correction.

4.52.1. For example, assume KNID TACAN runway (RWY) 32, a CAT C aircraft, and -20° Celsius (**Figure 4.10**). All altitudes on the approach plate need to be corrected since an intermediate approach altitude is greater than or equal to 3,000 feet above the altimeter setting source. (5300' MSL-2241' MSL=3059' MSL at JEBUR)

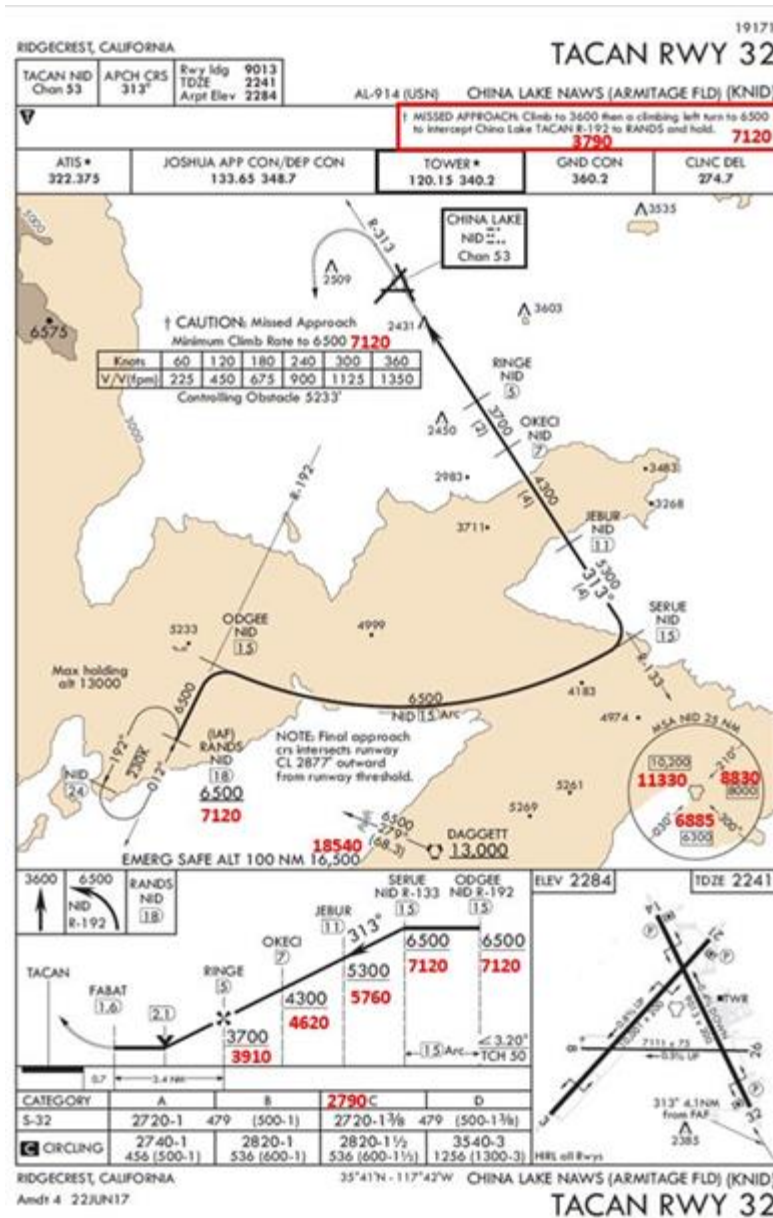


Figure 4.10. Temperature Correction Example, KNID, TACAN RWY 32.



4.52.2. To calculate the altitude correction for the initial approach fix (IAF) RANDES, determine the height above touchdown (HAT) at the IAF. In this example, the HAT at the IAF is 4259 feet ( $6500 - 2241 = 4259$ ). From the temperature correction chart, the altitude correction is  $(570 + 50) + 6500 = 7120$  MSL. Altitude correction is normally rounded up to the nearest 10. Follow the same calculation procedures for all altitudes on the approach plate (Figure 4.11).

Figure 4.11. Example Temperature Correction.



4.52.3. Calculate cold weather temperature corrections for remote altimeter settings using the following method: Follow the remote altimeter setting guidance published on the approach plate. Use the field elevation from the altimeter setting source. Subtract the remote altimeter source field elevation from the approach altitude to get the height above the altimeter setting source. Determine the temperature corrections in accordance with paragraphs 4.52.1 and 4.52.2. Using KATW ILS or LOC RWY 3 (Figure 4.12 and Figure 4.13) and -20° Celsius, the first step is to apply the remote altimeter setting published guidance. In this example, add 81 feet to the decision altitude (DA) (1088 + 81), the new DA is 1169. The next step is to determine the height above the altimeter setting source. In this example, the height above the altimeter source is (1169 – 695) 474 feet. Finally, determine the temperature correction. In this example, the new cold weather corrected DA is 1240.



Figure 4.12. KATW ILS or LOC RWY 3.

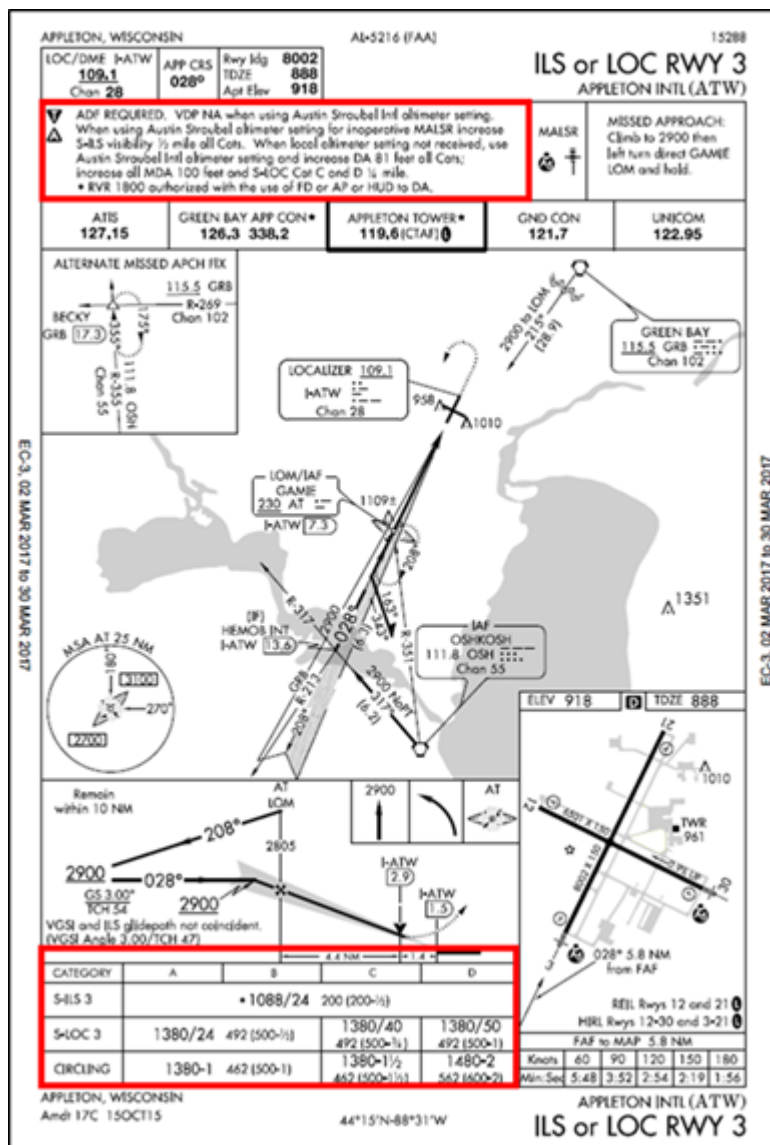


Figure 4.13. Cold Temperature Corrections – Remote Altimeter Setting.



4.53. FAA Cold Temperature Restricted Airports.

4.53.1. -[NTAP] In 2015, the FAA released a NOTAM implementing cold temperature altitude corrections at airfields with a published cold temperature restriction. FAA cold temperature restricted airports are identified by the “snowflake” icon and associated temperature limit published on U.S. Government IAP (Figure 4.14). The FAA procedures differ from USAF procedures. The main difference between the two procedures are the temperature limits set by each procedure and which approach altitudes are corrected. This USAF manual applies a standard set of criteria to all airfields to determine which altitudes need to be corrected. In contrast, the FAA procedure requires cold weather altitude corrections only at airfields, temperatures, and approach segments listed in the NTAP.

Figure 4.14. Snowflake Icon.



## Chapter 5

### DEPARTURE

**5.1. General.** Planning a safe departure normally consists of three steps: selecting a valid departure method, determining the required climb gradient, and ensuring performance meets or exceeds that climb gradient. Reference AIM 5-2-8, FAA-H-8083-15, and ICAO Doc 8168 Volume 1 for more detailed explanations and examples of departure procedures.

**5.2. Weather.** Do not take off when existing weather is below the lowest compatible approach minimums. **(T-2).** **Exception:** MAJCOMs may publish alternative takeoff minimums and recovery procedures when takeoff weather is lower than published lowest compatible approach minimums. In all cases, takeoff visibility must be 600 RVR (180 meters) or greater. **(T-1).**

**5.2. (AFMC) Weather.** AFMC takeoff alternate requirements for tanker/transport/bomber aircraft are listed in **Table 5.7** For fighter/trainer/UAS aircraft, the FOA may authorize takeoff for operational requirements when existing weather is below landing minimums if the visibility is at least 1,600 feet runway visual range (RVR) or 1/4-mile and a suitable alternate is located within 30 minutes flying time. The reported and forecast weather at the alternate must meet that required for an airport to qualify as an alternate, and the forecast crosswind component corrected for RCR must be within the recommended zone of the aircraft's landing crosswind chart.

**5.3. Hazardous Weather.** Do not take off where thunderstorms or other hazardous conditions are producing hail, strong winds, gust fronts, heavy rain, lightning, wind shear, or microbursts unless the runway and flight path are clear of hazards. **(T-3).**

**5.4. Freezing and Frozen Precipitation or Weather.** Do not take off with ice, snow, frost, or other contamination adhering to the wings, control surfaces, propellers, engine inlets, or other critical surfaces of the aircraft, unless authorized by the aircraft flight manual. **(T-1).**

**5.5. Aircraft Ground Deicing.** Aircrew will use the FAA aircraft ground deicing holdover times tables in conjunction with AF T.O. 42C-1-2, *Anti-Icing, De-Icing and Defrosting of Parked Aircraft*, MDS-specific Volume 3, and aircraft flight manual guidance. **(T-1).** The FAA ground deicing holdover times tables from the FAA web site is located at: [https://www.faa.gov/other\\_visit/aviation\\_industry/airline\\_operators/airline\\_safety/deicing/](https://www.faa.gov/other_visit/aviation_industry/airline_operators/airline_safety/deicing/).

#### **5.6. VFR Communication.**

5.6.1. [14 CFR Part 91.123] Pilots departing VFR must comply with ATC instructions when participating in radar services or flight following. **(T-0).**

5.6.2. It is important when departing from non-towered airfields for pilots to be vigilant for other aircraft both on the ground and in the air as well as other hazards to aircraft. When ready to depart, utilize the airfield Common Traffic Advisory Frequency (CTAF) or Universal Communication (UNICOM) frequency to announce aircraft location, departure runway, intentions, and direction of flight after departure.

5.6.3. Radio contact with ATC may not always be possible on the ground. In those instances, aircrew may either activate the VFR flight plan or obtain an IFR release through a ground communications relay station or with an FSS via telephone or radio once airborne.

**5.7. VFR Departure.** Pilots must “see and avoid” obstacles and terrain during VFR departures.

**5.7. (AFMC) VFR Departure.** Aircrew departing VFR along an IFR departure path are authorized to reduce applicable IFR climb gradients by up to 48'/NM for one engine inoperative performance planning. **Note:** This is applicable to obstacle climb gradients not ATC climb gradients. If unable to determine whether a given climb gradient is obstacle or ATC, assume it is an obstacle climb gradient. Aircrew departing VFR along an IFR departure path that cannot meet the applicable obstacle climb gradients require detailed planning to ensure obstacles and terrain are avoided.

**5.8. IFR Climb Performance.** Ensure the aircraft can meet or exceed 200 feet per nautical mile or the published climb gradient, whichever is higher, with all engines operating to the enroute structure or an altitude that will allow random (diverse) IFR flight. **(T-1).**

**5.8. (AFMC) IFR Climb Performance.** Units wishing to develop new SDPs must coordinate through AFMC/A3V via an AFMC Form 73. The FOA may authorize the use of published SDPs for OEI departure planning when necessary. This approval is limited to Jeppesen-generated MDS/Airport specific SDPs in accordance with criteria and data approved by HQ AFFSA/XO. Units will confirm the Jeppesen-generated MDS/airport specific SDPs produce sufficient performance data needed for safe operations. Units must validate the performance data against the aircraft flight manual prior to first use. SDP usage and risks shall be addressed during the safety review board for test missions and the sortie RM process. Fly SDP routing that differs from clearance routing only in an emergency unless approved by ATC. Prior to using SDPs aircrew will complete AFMC command specified training plan in accordance with AFMAN 11-2FTV1 and document certification on AF Form 1381, *USAF Certification of Aircrew Training* and the unit's *Letter of X*.

5.8.1. IFR Turns after Takeoff. The minimum turn altitude after takeoff is 400 feet above the DER elevation, unless required by a published procedure or ATC. **(T-0).**

5.8.2. Published or ATC climb gradients do not account for low close-in obstacles. Therefore, low close-in obstacle clearance is not assured when complying with IFR climb gradients. Ensure the aircraft can vertically or laterally clear applicable published low close-in obstacles along the planned ground track. **(T-0).**

5.8.3. PICs must plan a contingency procedure to account for one engine inoperative on takeoff for multi-engine fixed-wing aircraft. Acceptable methods include any of the following:

5.8.3.1. Special Departure Procedure (SDP);

5.8.3.2. Non-standard takeoff minimums to vertically or laterally clear all obstacles; or,

5.8.3.3. Published climb gradient or 200 feet per nautical mile (whichever is higher) with one engine inoperative.

5.8.3.4. If no other departure methods are available, and the mission justifies the increased risk, the PIC may, after extensive preflight planning, reduce up to 48 feet per nautical mile from the required climb gradient.

**5.9. IFR Departure Methods.** Pilots will fly all departure procedures as published. **(T-0).** Pilots will depart IFR using the methods listed below:

5.9.1. Diverse Departure

5.9.2. [ICAO] Omnidirectional Departure.

## 5.9.3. Obstacle Departure Procedure (ODP).

5.9.3.1. Non-Standard Takeoff Minimums;

5.9.3.2. Specific Routing;

5.9.3.3. Visual Climb Over Airport (VCOA);

5.9.3.3. (AFMC) Unit commander may approve use of VCOA procedures after completion of an AFMC/A3V approved VCOA training plan.

5.9.3.4. Reduced Takeoff Runway Length Procedure (RTRL); or

5.9.3.5. Any combination of the above.

## 5.9.4. Diverse Vector Area (DVA).

## 5.9.5. Specific ATC Departure Instructions.

5.9.6. Standard Instrument Departure (SID). **Note:** Pilots will notify ATC (or other traffic) when planning to depart via an ODP. **(T-0)**.

## 5.9.7. MAJCOM-Certified Procedure.

5.9.7. (AFMC) MAJCOM Certified Procedure. Units wishing to receive special MAJCOM certification for procedures must coordinate through AFMC/A3V via an AFMC Form 73. AFMC/A3V will coordinate with AFMC/A3O for approval.

## 5.9.8. Special Departure Procedure (SDP).

**5.10. IFR Departure Climb Gradients.** [ICAO Doc 8168 Volume 2, Part I, Section 3, Chapter 2]5.10.1. The standard IFR departure climb gradient is 3.3% (200 feet per nautical mile); it begins at 16 feet above the DER. See **Table 5.1** for standard IFR DER crossing restrictions. Pilots under IFR must plan to cross the DER at or above these restrictions unless otherwise published or MAJCOM-directed procedures direct otherwise (e.g., SDPs.). **(T-0)**.**Table 5.1. IFR DER Crossing Restrictions (Unless Published Otherwise).**

| Design Criteria | Crossing Restriction (Feet) |
|-----------------|-----------------------------|
| USAF / USN      | 0                           |
| ICAO / NATO     | 16                          |
| FAA / USA       | 0 – 35                      |

5.10.2. [FAA Order 8260.3] The departure climb gradient begins at 0 feet above the DER elevation under current U.S. Terminal instrument procedures (TERPS) criteria; however, many procedures developed under older U.S. TERPS criteria still have an unpublished DER crossing restriction of 35 feet.

5.10.2.1. All USAF and United States Navy (USN) departure climb gradients begin at 0 feet above the DER elevation unless published otherwise.

5.10.2.2. FAA and United States Army (USA) departure climb gradients begin between 0 feet and 35 feet above the DER elevation. There is no consistent method for a pilot to determine the required DER crossing restriction for an FAA or USA departure procedure.

5.10.2.2.1. [AIM 5-2-8] Unless specified otherwise, the required obstacle clearance for all FAA and USA departures, including diverse departures, is based on the pilot crossing the DER at least 35 feet above the DER elevation, climbing to 400 feet above the DER elevation before making the initial turn, and maintaining a minimum climb gradient of 200 feet per nautical mile, unless required to level off by a crossing restriction, until the minimum IFR altitude.

5.10.2.2.2. The FAA is the Senior Airfield Authority at joint-use airfields and is responsible for all instrument procedures; therefore, pilots should plan to cross the DER at least 35 feet above the DER elevation at joint-use airfields.

5.10.2.2.3. If in doubt, or the 35-foot restriction limits mission capability, contact the MAJCOM TERPS office for the actual DER crossing restriction.

**5.11. ICAO Departure Speeds.** ICAO design criteria is based on the maximum departure airspeeds in [Table 5.2](#) **Note:** If exceeding these speeds, there is no guarantee of obstacle clearance.

**Table 5.2. ICAO Maximum Allowable Departure Speeds.**

| Aircraft Category | Max Indicated Airspeed (knots) |
|-------------------|--------------------------------|
| A                 | 120                            |
| B                 | 165                            |
| C                 | 265                            |
| D                 | 290                            |
| E                 | 300                            |
| H                 | 90                             |

**5.12. IFR Departure Procedures.** Airfields with IFR departure procedures designed to assist pilots in avoiding obstacles during the climb to the minimum enroute altitude (MEA), or airfields that have civil IFR takeoff minimums other than standard, are listed in the “IFR TAKEOFF MINIMUMS, OBSTACLE DEPARTURE PROCEDURES, AND DIVERSE VECTOR AREAS (RADAR VECTORS)” of the terminal procedures publication, commonly called the “Trouble T” section.

5.12.1. The “Trouble T” symbol on all published instrument procedures for an airfield notifies pilots that departure procedures exist ([Figure 5.1](#)).

**Figure 5.1. “Trouble T” Symbol.**



5.12.2. Takeoff minimums and departure procedures apply to specific runways unless otherwise stated. An entry may also be listed that contains only takeoff obstacle notes. Altitudes, unless otherwise indicated, are minimum MSL altitudes.

5.12.3. IFR departure procedures specifically designed for obstacle avoidance are referred to as obstacle departure procedures (ODP) and are textually described in the “Trouble T” section

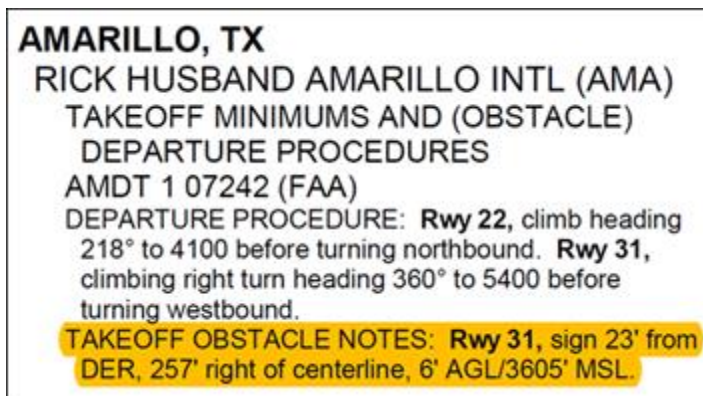


of the terminal procedures publication or published separately as a graphic procedure. Pilots may recognize graphic ODPs by the term “(OBSTACLE)” included in the procedure title (e.g., “TETON THREE DEPARTURE (OBSTACLE)”). **Note:** Aircraft may not be vectored off an ODP, or issued an altitude lower than the published altitude on an ODP, until at or above the Minimum Vectoring Altitude (MVA)/minimum IFR altitude, at which time the ODP is canceled.

**5.13. Takeoff Obstacle Notes.** Obstacles within 3 statute miles of the DER identified during the diverse departure obstacle assessment that require a climb gradient greater than 200 feet per nautical mile are published under “TAKE-OFF OBSTACLE NOTES” in the “Trouble T” section (Figure 5.2). The purpose of this section is to identify the obstacles and alert the pilot to the height and location of the obstacles so they can be seen and avoided.

**5.14. Low Close-in Obstacles.** Obstacles that require a climb gradient greater than 200 feet per nautical mile for a very short distance, only until the aircraft is 200 feet above the DER, are referred to as “low, close-in obstacles.”

**Figure 5.2. Low Close-in Obstacles.**



**5.15. Diverse Departure.** [FAA Order 8260.46] An instrument procedure specialist conducts a diverse departure assessment to determine if an obstacle penetrates the 40:1 obstacle identification surface (OIS). The 40:1 OIS is equivalent to 152 feet per nautical mile; an additional 48 feet per nautical mile or more of required obstacle clearance is added to the 40:1 OIS, making the standard IFR departure climb gradient 200 feet per nautical mile.

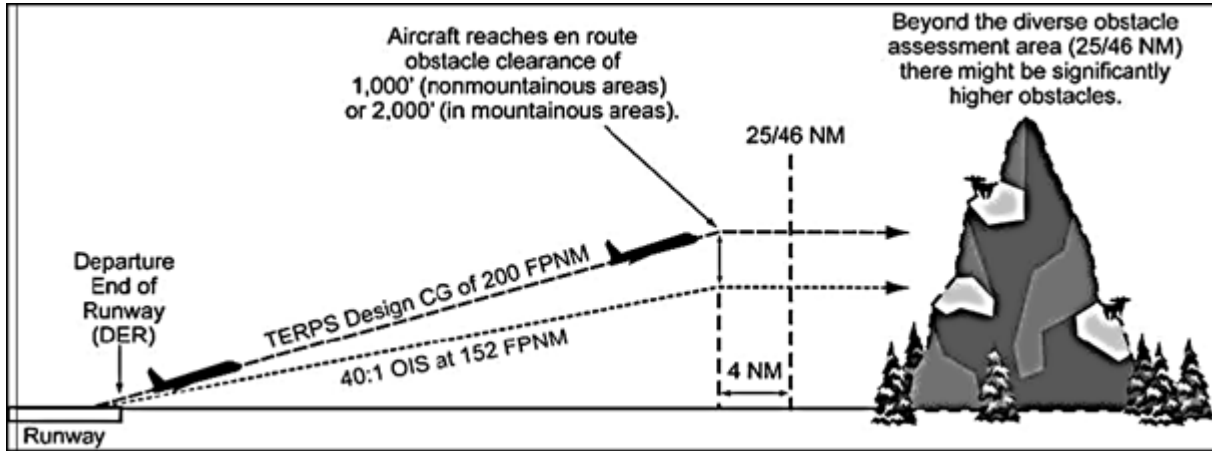
5.15.1. A diverse departure may be authorized if no obstacles, other than low close-in obstacles, penetrate the 40:1 OIS. ATC does not specifically clear pilots for a diverse departure nor can pilots file it on a flight plan.

5.15.2. Pilots are not authorized to fly diverse departures when an ODP, obstacle climb gradient, or non-standard takeoff weather minimums are published for the planned departure runway. **(T-0).**

5.15.3. The diverse departure obstacle assessment area is limited to 25 nautical miles from the airfield in non-mountainous terrain and 46 nautical miles in designated mountainous areas (Figure 5.3). Beyond this distance, the pilot is responsible for obstacle clearance if not operating on a published route, below the MEA or minimum obstruction clearance altitude (MOCA) of a published route, or below an ATC-assigned altitude. Pilots should check terrain

and obstacle information for areas surrounding the immediate terminal area when planning any instrument departure.

**Figure 5.3. Diverse Departure Obstacle Assessment.**



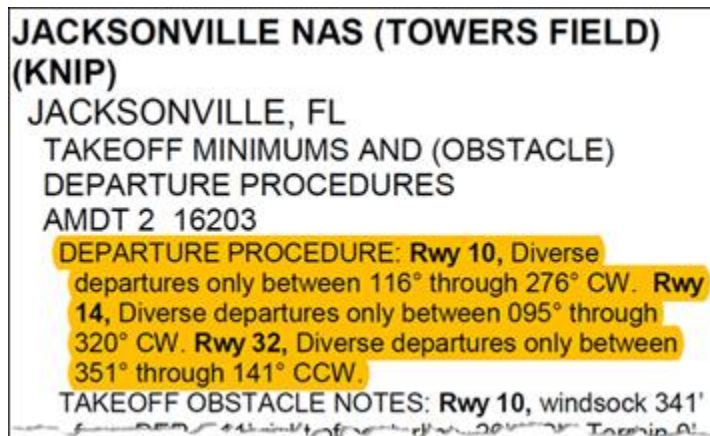
5.15.4. A diverse departure is an acceptable IFR departure method for a specific runway unless that runway has a published ODP listed in the “Trouble T” section of the terminal procedures publication (**Figure 5.4**). ODP in this case is defined as: non-standard climb gradient, non-standard weather minimums, or a departure procedure. Low close-in obstacles alone do not constitute an ODP.

**Figure 5.4. Diverse Departure Not Authorized (Runway 36R).**

HUNTSVILLE, AL  
 HUNTSVILLE INTL-CARL T JONES FIELD  
 (HSV)  
 TAKEOFF MINIMUMS AND (OBSTACLE)  
 DEPARTURE PROCEDURES  
 AMDT 4A 18032 (FAA)  
 DEPARTURE PROCEDURE: Rwy 36R, climb heading  
 005° to 1600 before turning right.  
 TAKEOFF OBSTACLE NOTES: Rwy 18L, trees  
 heading 109° from DER 310' left of centerline up to

5.15.5. Sector diverse departures only allow for diverse departures within specific sector requirements (**Figure 5.5**).

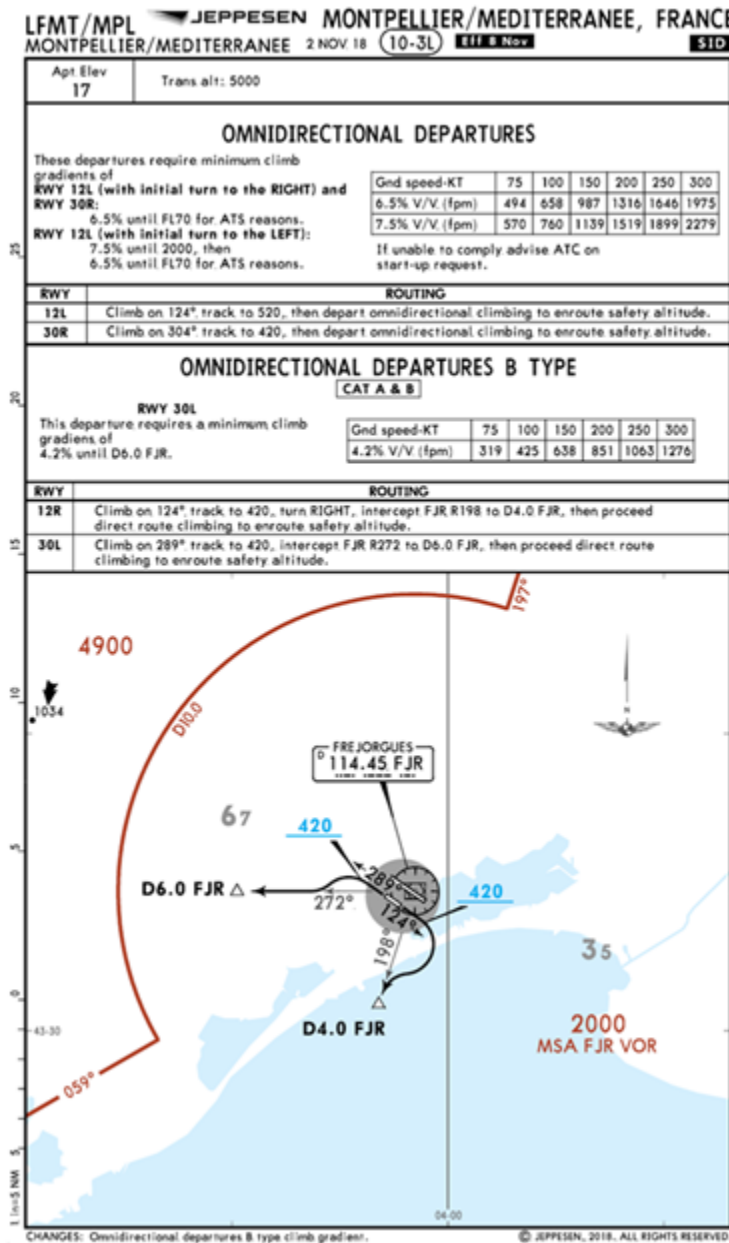


**Figure 5.5. Sector Diverse Departure.**

**5.16. ICAO Omnidirectional Departure.** [ICAO Doc 8168 Volume 1, Part I, Section 3, Chapter 3] The omnidirectional departure is a departure procedure without any track guidance provided or available (**Figure 5.6**). It is similar to the FAA’s diverse departure with a very important difference: the omnidirectional departure may be published even with OIS penetrations. The instrument procedure specialist may design the omnidirectional departure procedure using any combination of the following:

- 5.16.1. Departure restrictions are not published when obstacles do not penetrate the 40:1 OIS and an additional 246 feet of required obstacle clearance exists. Pilots may turn in any direction upon reaching 400 feet above DER elevation.
- 5.16.2. The procedure specifies a 200 foot per nautical mile climb to an altitude at which omnidirectional turns may be made when obstacles preclude turns at 400 feet.
- 5.16.3. The procedure may define a minimum climb gradient of more than 200 feet per nautical mile to a specified altitude before turns are permitted.
- 5.16.4. The procedure may identify sectors for which either a minimum climb gradient or a minimum turn altitude is specified (e.g., “Climb straight ahead to 2,000 feet before commencing a turn to the east/sector 0 degrees to 179 degrees and climb to 1,800 feet before commencing a turn to the west/sector 180 degrees to 359 degrees”).
- 5.16.5. Pilots must maintain at least the standard IFR climb gradient from the altitude at which turns in any direction are allowed until reaching a minimum IFR altitude. **(T-0)**.

Figure 5.6. Omnidirectional Departure.



**5.17. Non-standard IFR Takeoff Minimums.** Non-standard IFR takeoff minimums are provided for pilots to “see and avoid” obstacles during departure when obstacles penetrate the 40:1 OIS within 3 statute miles from the DER (Figure 5.7 and Figure 5.8). Weather must be equal to or better than the published ceiling and visibility to depart using non-standard IFR takeoff minimums and climb at 200’/NM or higher if published. **Note:** The standard or published climb gradient does not provide vertical clearance from the controlling obstacle.

**Figure 5.7. IFR Takeoff Minimums – Non-standard.**

**ANDREWS, SC**  
**ROBERT F. SWINE (PHH)**  
 TAKEOFF MINIMUMS AND (OBSTACLE)  
 DEPARTURE PROCEDURES  
 ORIG 02276 (FAA)  
 TAKEOFF MINIMUMS: **Rwy 18, 300-1. Rwy 36, 400-1.**

**Figure 5.8. IFR Takeoff Minimums – Non –standard.**

**RUIDOSO, NM**  
**SIERRA BLANCA RGNL (SRR)**  
 TAKEOFF MINIMUMS AND (OBSTACLE)  
 DEPARTURE PROCEDURES  
 ORIG 89124 (FAA)  
 TAKEOFF MINIMUMS: **Rwys 6,24, 5200-3** or std. with a  
 min. climb of 420' per NM to 12100'.  
 DEPARTURE PROCEDURE: **Rwy 6**, climb at 385' per NM  
 to 9100' direct CEP NDB, continue climb in holding pattern  
 (\*hold E, left turns, 273° inbound) to cross CEP NDB at or  
 above the MEA for direction of flight. \*Do not exceed 230  
 kts in holding pattern. **Rwy 24**, immediate climbing left turn  
 to 9100' direct CEP NDB, continue climb in holding pattern  
 (\*hold E, left turns, 273° inbound) to cross CEP NDB at or  
 above the MEA for direction of flight . \*Do not exceed 230  
 kts in holding pattern.

5.17.1. A minimum climb gradient is published when obstacles penetrate the 40:1 OIS beyond 3 statute miles from the DER. Some non-standard takeoff weather minima list a specific climb gradient that may be used with “standard” weather minima or alternate procedures for a standard climb gradient ([Figure 5.9](#)).

**Figure 5.9. IFR Takeoff Minimums – “Or Standard”.**

**CLARKSVILLE, TN**  
**OUTLAW FIELD (CKV)**  
 TAKEOFF MINIMUMS AND (OBSTACLE)  
 DEPARTURE PROCEDURES  
 AMDT 2 06271 (FAA)  
 TAKEOFF MINIMUMS: **Rwy 35, 300-1 or std. w/ min.**  
 climb of 240' per NM to 800. Alternatively, with standard  
 takeoff minimums and a normal 200'/NM climb gradient,  
 takeoff must occur no later than 1900' prior to DER.

5.17.2. Occasionally, IFR takeoff minimums are published that are specific to a certain category of aircraft ([Figure 5.10](#)). Pilots will use the aircraft approach category from the aircraft flight manual for procedures that specify an aircraft category. **(T-0)**.

**Figure 5.10. IFR Takeoff Minimums – Specific Aircraft Category.**

|  |
|--|
| <p><b>GALLUP, NM</b><br/> <b>GALLUP MUNI (GUP)</b><br/> <b>TAKEOFF MINIMUMS AND (OBSTACLE)</b><br/> <b>DEPARTURE PROCEDURES</b><br/> <b>AMDT 2 94230 (FAA)</b></p> <p><b>TAKEOFF MINIMUMS: Rwy 6, CAT A,B 1300-2 or std. with a min. climb of 300' per NM until passing 8000. CAT C,D 1600-3 or std. with a min. climb of 320' per NM until passing 8500. Rwy 24, 700-2 or std. with a min. climb of 370' per NM until passing 8000.</b></p> |
|--|

**5.18. Specific Routing.** The instrument procedure designer may publish specific routing to avoid obstacles under the “DEPARTURE PROCEDURE” section of the ODP (**Figure 5.11**).

**Figure 5.11. Specific Routing.**

|   |
|---|
| <p><b>LA JUNTA, CO</b><br/> <b>LA JUNTA MUNI (LHX)</b><br/> <b>TAKEOFF MINIMUMS AND (OBSTACLE)</b><br/> <b>DEPARTURE PROCEDURES</b><br/> <b>AMDT 3A 16091 (FAA)</b></p> <p><b>DEPARTURE PROCEDURE: Rwy 8, climb via heading 080°. Rwy 12, climb via heading 120°. Rwy 26, turn left heading 160°. Rwy 30, turn left heading 140°. All aircraft, intercept LAA R-238 (V210) to LAA VOR/DME. When at or above 8000 proceed on course.</b></p> |
|---|

**5.19. Visual Climb Over Airport (VCOA).** A VCOA procedure is a departure option for an IFR aircraft, operating in VMC equal to or greater than the specified visibility and ceiling, to visually conduct climbing turns over the airfield to the published “climb-to” altitude. Upon reaching this altitude, the aircraft may proceed with the instrument portion of the departure.

5.19.1. MAJCOMs may authorize the use of VCOA procedures. Pilots will remain within the published visibility distance, will not exceed this radius from the center of the airfield while climbing to the specified altitude, and will visually identify the obstacles throughout the climb. **(T-1).**

5.19.2. Pilots are responsible to advise ATC as early as possible of the intent to fly the VCOA procedure prior to departure.

5.19.3. Pilots are prohibited from constructing their own VCOA. **(T-0).**

5.19.4. Group Commanders or the command and control authority may approve unaided night VCOA operations.

5.19.5. VCOA procedures do not guarantee an obstacle-free flight path during the visual portion of the maneuver. After reaching the published climb-to altitude, pilots must ensure the aircraft can meet or exceed the standard or published climb-gradient. **(T-0).**

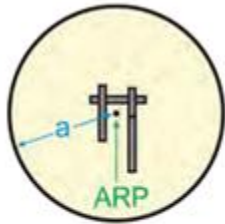
5.19.6. -[FAA Order 8260.3] Procedure designers construct a visual climb area around the airport reference point to develop VCOA procedures. The visual climb area is a circle

computed by adding the radius value from [Table 5.3](#) and the distance from the airport reference point to the most distant runway end ([Figure 5.12](#)). The VCOA ceiling is a minimum of 250 feet above the highest obstacle within the visual climb area.

**Table 5.3. VCOA Radius Value.**

| Speed KIAS | Below 2,000 feet (MSL) | Below 5,000 feet (MSL) | Below 10,000 feet (MSL) | 10,000 feet and Above |
|------------|------------------------|------------------------|-------------------------|-----------------------|
| 90         | 2.0                    | 2.0                    | 2.0                     | 2.0                   |
| 120        | 2.0                    | 2.0                    | 2.0                     | 2.0                   |
| 180        | 2.0                    | 2.0                    | 2.5                     | 3.4                   |
| 210        | 2.1                    | 2.5                    | 3.2                     | 4.3                   |
| 250        | 2.8                    | 3.4                    | 4.2                     | 5.5                   |

**Figure 5.12. Visual Climb Area.**



$a = R1$  (table 14-4-1) plus the distance from ARP to most distant DER

5.19.7. VCOA procedures are normally published as a textual ODP; however a VCOA may appear as a note on a graphical ODP.

5.19.7.1. A VCOA procedure has a published non-standard ceiling and visibility directly associated with the words “for VCOA” in the “TAKEOFF MINIMUMS” section of the ODP ([Figure 5.13](#)). It also includes the instructions “obtain ATC approval for VCOA when requesting IFR clearance” and “climb in visual conditions” to cross a specified airfield, NAVAID, or fix at or above a specified altitude before proceeding on course in the “VCOA” section of the ODP.



**Figure 5.13. VCOA Format.**

**CEDAR CITY, UT**  
**CEDAR CITY RGNL (CDC)**  
**TAKEOFF MINIMUMS AND (OBSTACLE)**  
**DEPARTURE PROCEDURES**  
**AMDT 3A 17229 (FAA)**  
**TAKEOFF MINIMUMS: Rwy 8, 4200-3 for VCOA. Rwy 20, std. w/min. climb of 290' per NM to 7300 or 4200-3 for VCOA. Rwy 26, std. w/min. climb of 255' per NM to 7000 or 4200-3 for VCOA.**  
**DEPARTURE PROCEDURE: Rwy 2, 8, climbing left turn direct EHK VOR/DME, thence... Rwy 20, 26, climbing right turn direct EHK VOR/DME, thence... ...continue climb on EHK VOR/DME R-278 until reaching the MEA/MCA for direction of flight.**  
**VCOA: Rwy 8, 20, 26, obtain ATC approval for VCOA when requesting IFR clearance. Climb in visual conditions to cross Cedar City Rgnl airport at or above 9700, then proceed on EHK VOR/DME R-180 direct EHK VOR/DME, then on EHK VOR/DME R-278 until reaching the MEA/MCA for direction of flight.**

5.19.7.2. A VCOA procedure published under old standards that is not updated has a published non-standard ceiling and visibility directly associated with the words “for climb in visual conditions” in the “TAKEOFF MINIMUMS” section of the ODP (**Figure 5.14**). It also includes the instructions “for climb in visual conditions” to cross a specified airfield, NAVAID, or fix at or above a specified altitude before proceeding on course in the “DEPARTURE PROCEDURE” section of the ODP.

**Figure 5.14. Legacy VCOA Format.**

**BULLHEAD CITY, AZ**  
**LAUGHLIN/BULLHEAD INTL (IFP)**  
**TAKEOFF MINIMUMS AND (OBSTACLE)**  
**DEPARTURE PROCEDURES**  
**AMDT 1 09183 (FAA)**  
**TAKEOFF MINIMUMS: Rwy 16, std. w/ a min. climb of 370' per NM to 1800, or 1700-3 for climb in visual conditions. Rwy 34, std. w/ a min. climb of 495' per NM to 5500, or 1700-3 for climb in visual conditions.**  
**DEPARTURE PROCEDURE: Rwy 16, climb via heading 164° and EED VORTAC R-334 to EED VORTAC, or for climb in visual conditions: cross Laughlin/Bullhead Intl airport at or above 2300, then continue climbing via heading 155° and EED VORTAC R-335 to EED VORTAC. Rwy 34, climb via heading 344° to 1600, then climbing right turn direct EED VORTAC, or for climb in visual conditions: cross Laughlin/Bullhead Intl airport at or above 2300, then continue climbing via heading 155° and EED VORTAC R-335 to EED VORTAC. All Aircraft climb in EED VORTAC holding pattern (East, right turn, 257° inbound) to cross EED VORTAC at or above MEA for direction of flight before proceeding on course.**

5.19.7.3. Some VCOA procedures may not conform to either format listed above. Contact the MAJCOM TERPS office to determine if a VCOA is authorized ([Figure 5.15](#)).

**Figure 5.15. Non-Conforming VCOA Format.**

|   |
|---|
| <p><b>AMEDEE AAF (KAHC),<br/>HERLONG, CA. . . . . Amdt 1, 09239</b><br/> <b>Rwy 8, 26: 4000-3 for climb in visual conditions.</b><br/> <b>Rwy 8, 26: Cross Amedee AAF at or above 7900<br/>before proceeding on course.</b></p> |
|---|

**5.20. Reduced Takeoff Runway Length Procedure (RTRL).** If all obstacles penetrate the OIS by 35 feet or less, the instrument procedure specialist may artificially limit the takeoff runway length available to achieve a standard climb gradient of 200 feet per nautical mile ([Figure 5.16](#)). An RTRL procedure requires the aircraft to lift off the runway at or prior to a specified distance from the DER. In the example below, subtract the value in the RTRL procedure from the usable runway length to determine the reduced runway length. If the reduced length is equal to or greater than the aircraft’s calculated ground run, the procedure may be flown using a standard climb gradient of 200 feet per nautical mile.

**Figure 5.16. RTRL Procedure.**

|   |
|---|
| <p><b>ANTIGO, WI</b><br/> <b>LANGLADE COUNTY (AIG)</b><br/> <b>TAKEOFF MINIMUMS AND (OBSTACLE)</b><br/> <b>DEPARTURE PROCEDURES</b><br/> <b>AMDT 1 13206 (FAA)</b><br/> <b>TAKEOFF MINIMUMS: Rwy 9, 300-2¼ or std. w/min.</b><br/> <b>climb gradient of 215' per NM to 1900, or alternatively,</b><br/> <b>with standard takeoff minimums and a normal 200' per</b><br/> <b>NM climb gradient, takeoff must occur no later than</b><br/> <b>1700' prior to DER.</b></p> |
|---|

**5.21. Combination of Methods.** The instrument procedure specialist may use a combination of the previously described methods to construct an ODP. In [Figure 5.17](#), the pilot has to comply with required climb gradient in the “TAKEOFF MINIMUMS” and the routing in the “DEPARTURE PROCEDURE,” or request the VCOA, for runways 6, 16, and 24; an IFR departure from runway 34 is not allowed.

**Figure 5.17. Combination of Methods.**

|   |
|---|
| <p><b>ROANOKE, VA</b><br/> <b>ROANOKE-BLACKSBURG RGNL/<br/> WOODRUM FIELD (ROA)</b><br/> <b>TAKEOFF MINIMUMS AND (OBSTACLE)<br/> DEPARTURE PROCEDURES</b><br/> <b>AMDT 11 15344 (FAA)</b></p> <p><b>TAKEOFF MINIMUMS: Rwy 6</b>, std. w/ min. climb of 585' per NM to 3000, or 2600-3 for climb in visual conditions. <b>Rwy 16</b>, std. w/ min. climb of 340' per NM to 3000, or 2600-3 for climb in visual conditions. <b>Rwy 24</b>, std. w/ min. climb of 242' per NM to 2800, or 2600-3 for climb in visual conditions. <b>Rwy 34</b>, NA-Obstacles.</p> <p><b>DEPARTURE PROCEDURE: Rwy 6</b>, climb on heading 058° to 3200 before proceeding on course. <b>Rwy 16</b>, climb on heading 156° to 3000 before proceeding on course. <b>Rwy 24</b>, climb on heading 238° and on I-SZK LDA localizer west course to 4200 to DIXXY INT/I-SZK 15.25 DME before proceeding on course.</p> <p><b>VISUAL CLIMB:</b> Obtain ATC approval for VCOA when requesting IFR clearance. Climb in visual conditions to cross Roanoke-Blacksburg Rgnl/Woodrum Field at or above 3600 before proceeding on course.</p> |
|---|

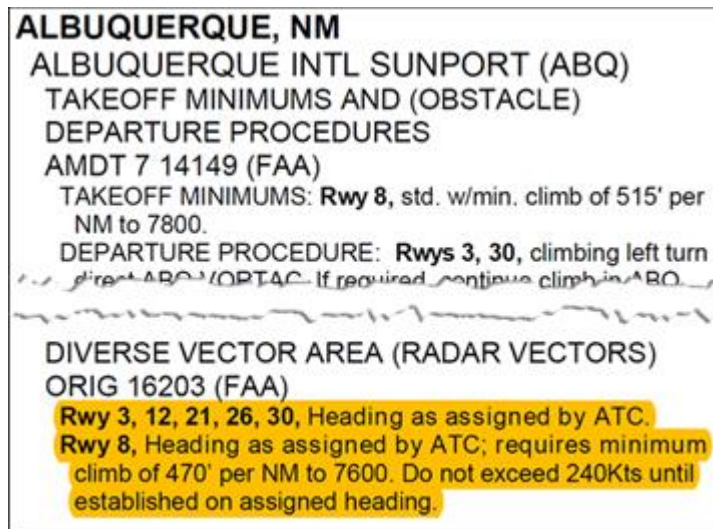
**5.22. Diverse Vector Area (DVA).** [FAA-H-8083-16] A DVA may be created to allow radar vectors to be used in lieu of an ODP at some locations where an ODP has been established. DVA information states that headings are as assigned by ATC and climb gradients, when applicable, may be published immediately following the specified departure procedure (**Figure 5.18**). DVAs have been assessed for departures which do not follow a specific ground track. **Note:** DoD locations are not required to publish DVA information in the terminal procedures publication.

5.22.1. Pilots will determine if a DVA is published and if the aircraft is capable of meeting the published climb gradient. **(T-0)**. Pilots will advise ATC when requesting the IFR clearance, or as soon as possible, if unable to meet the DVA climb gradient. **(T-0)**.

5.22.2. DVAs require the standard IFR departure climb gradient unless a higher than standard IFR climb gradient is published either under “DIVERSE VECTOR AREA (RADAR VECTORS)” in the “Trouble T” section of the terminal procedures publication, ATC issues a required climb gradient, or there is a higher than standard climb gradient required for an ODP for that runway.

5.22.3. IFR departure climb gradients published under the “TAKEOFF MINIMUMS” or “DEPARTURE PROCEDURE” in the “Trouble T” section of the terminal procedures publication do not apply to DVAs. However, low close-in obstacles must always be accounted for in takeoff planning.



**Figure 5.18. Diverse Vector Area.****5.23. Specific ATC Departure Instructions.** [FAA JO 7110.65]

5.23.1. Specific ATC departure instructions include a heading and an altitude. **Note:** These instructions are not considered radar vectors.

5.23.2. Do not apply wind drift corrections. **(T-1).**

5.23.3. [ICAO] [ICAO Doc 8168 Volume 1, Part I, Section 3, Chapter 1] Pilots should not accept radar vectors during departure unless:

5.23.3.1. They are above the minimum altitude(s)/height(s) required to maintain obstacle clearance in the event of engine failure. This relates to engine failure between V1 and minimum sector altitude or the end of the contingency procedure as appropriate; or

5.23.3.2. The departure route is non-critical with respect to obstacle clearance.

5.23.4. [NAS and OCONUS Military Fields] ATC Departure instructions must be consistent with published departure procedures or a Diverse Vector Areas (DVA). Therefore, USAF pilots must fly the ODP prior to the ATC departure instructions, except when departing via a DVA or a Radar Vector SID or if the pilot can visually verify the intended flight path is clear of obstacles (see-and-avoid). If the departure instructions conflict with the ODP or with terrain or obstacles in the direction of departure, query the controller. The PIC is responsible for terrain clearance until under radar control.

**5.24. Standard Instrument Departure (SID).** A SID is a departure procedure established at certain airfields to simplify clearance delivery procedures and assist in meeting environmental, capacity, and ATC requirements. SIDs may be requested by specific ATC facilities, military services, or other users to enhance operations. SIDs also provide protection from obstacles; however, they are not ODPs and may not be flown unless approved by ATC.

5.24.1. A heavy black line on the graphic version depicts a SID route; thin black lines on the graphic version show transition routings.

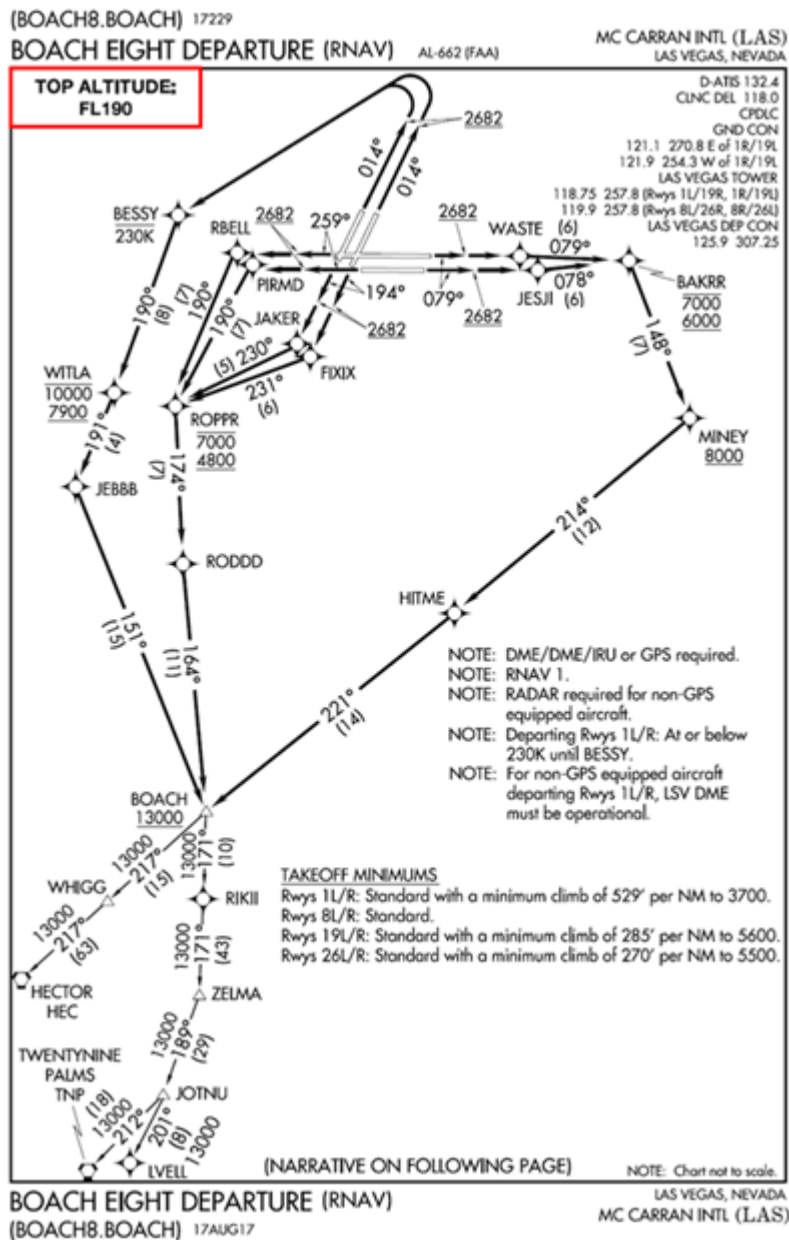
5.24.2. If a higher than standard climb gradient is required, it is published on the SID.

5.24.3. Expect an ATC clearance containing a SID at locations where one is published. If unable to fly a SID, include “NO SID” in the remarks section of the flight plan or contact ATC as soon as possible.

5.24.4. SIDs may include altitude restrictions necessary for ATC or obstacle clearance; the reason for the restriction may not be published. The “top altitude” is the charted “maintain” altitude contained in the procedure description or assigned by ATC (**Figure 5.19**).

5.24.5. Pilots will not fly a SID without ATC clearance. (**T-0**).

**Figure 5.19. Civil SID with Top Altitude.**



5.24.6. ATC anticipates aircraft begin adjusting speed the minimum distance necessary prior to a published speed restriction to cross the waypoint or fix at the published speed. Once at the

published speed ATC expects the aircraft to maintain published speed until additional adjustment is required to comply with further published or ATC-assigned speed restrictions.

**5.25. SID Clearances.** The filed or expected altitude is not relevant and has no bearing on the SID unless communications are lost between the pilot and ATC. Airspeed restrictions always remain in effect even on amended clearances unless the controller explicitly cancels or amends the speed restrictions. The pilot may consider the SID cancelled unless the controller adds “expect to resume SID” if radar vectored or cleared off an assigned SID. **Note:** ATC cannot waive the 250 knots below 10,000 feet speed restriction at any time within the NAS [14 CFR Part 91.117].

5.25.1. -[AIM Section 2] In the NAS:

5.25.1.1. SID phraseology is in accordance with [Table 5.4](#)

5.25.1.2. If ATC issues a new altitude restriction, all previously issued altitude restrictions are cancelled, including those published on the SID. Comply with all speed restrictions and lateral path requirements published on the SID unless cancelled by ATC. **(T-1)**.

5.25.1.3. Inform ATC upon initial contact of the altitude leaving and any assigned restrictions not published on the procedure if cleared to “climb via SID.”

5.25.1.4. ATC issues a “climb via SID” clearance if ATC reinstates the SID after issuing vectors to an aircraft. Comply with lateral navigation, vertical navigation, and speed restrictions unless otherwise directed by ATC.

5.25.1.5. Aircraft instructed to resume a SID that contains speed or altitude restrictions are issued all applicable restrictions or advised to comply with published restrictions.

**Table 5.4. NAS SID Phraseology.**

| <b>ATC Instruction</b>  | <b>Explanation</b>  |
|---|---|
| “Cleared Boach Six departure”   | - Follow the lateral profile of the SID   |
| “Cleared Boach Six departure, climb and maintain eleven thousand.”  | - Follow the lateral profile of the SID   |
| “Cleared Boach Six departure, climb via SID.”   | - Follow the lateral profile of the SID<br>- Comply with altitude restrictions while climbing to the SID top altitude   |
| “Cleared Boach Six departure, climb via SID except maintain eleven thousand.”                               | - Follow the lateral profile of the SID<br>- Comply with altitude restrictions while climbing to the assigned altitude; stop climb at the assigned altitude until issued further clearance by ATC |
| “Cleared Boach Six departure, climb via SID except cross WITLA at nine thousand.”                           | - Follow the lateral profile of the SID<br>- Comply with altitude restrictions while climbing to cross the waypoint at the assigned altitude<br>- Fly the remainder of the SID as published       |
| <b>Note:</b> Always comply with speed restrictions or ATC-issued speed control instructions, as applicable. |   |

5.25.2. -[ICAO Doc 4444] (ICAO) ATC clearances issued to aircraft on a SID include if remaining speed or level restrictions are to be followed or cancelled; standard clearance phraseology is shown in [Table 5.5](#)

5.25.2.1. If there are no remaining published level or speed restrictions on the SID, the phrase “climb to *[level]*” should be used.

5.25.2.2. When subsequent speed restrictions are issued, and if the cleared level is unchanged, the phrase “climb via SID to *[level]*” should be omitted.

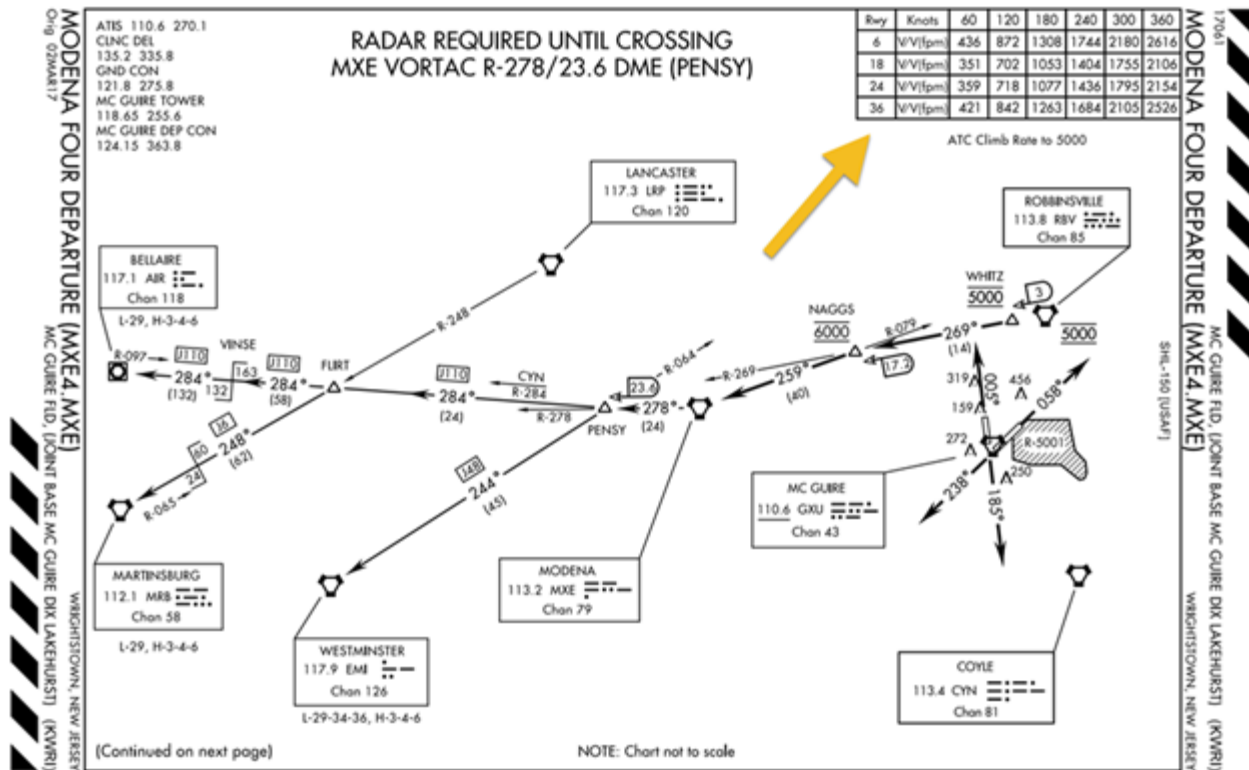
5.25.2.3. When a departing aircraft is cleared to proceed direct to a published waypoint on the SID, the speed and level restrictions associated with the bypassed waypoints are cancelled. All remaining published speed and restrictions remain applicable.

**Table 5.5. ICAO SID Phraseology.**

| ATC Instruction   | Explanation   |
|---|---|
| CLIMB VIA SID TO <i>(level)</i>   | <ul style="list-style-type: none"> <li>- Climb to the cleared level and comply with published level restrictions</li> <li>- Follow the lateral profile of the SID</li> </ul>  |
| CLIMB VIA SID TO <i>(level)</i> , CANCEL LEVEL RESTRICTION(S)   | <ul style="list-style-type: none"> <li>- Climb to the cleared level, published level restrictions are cancelled</li> <li>- Follow lateral profile of the SID</li> </ul>   |
| CLIMB VIA SID TO <i>(level)</i> , CANCEL LEVEL RESTRICTION(S) AT <i>(point(s))</i>                      | <ul style="list-style-type: none"> <li>- Climb to the cleared level, published level restriction(s) at the specified point(s) are cancelled</li> <li>- Follow the lateral profile of the SID</li> </ul>   |
| CLIMB VIA SID TO <i>(level)</i> , CANCEL SPEED RESTRICTION(S)   | <ul style="list-style-type: none"> <li>- Climb to the cleared level and comply with published level restrictions</li> <li>- Follow lateral profile of the SID</li> <li>- Published speed restrictions and ATC-issued speed control instructions are cancelled</li> </ul>    |
| CLIMB VIA SID TO <i>(level)</i> , CANCEL SPEED RESTRICTION(S) AT <i>point(s)</i>                        | <ul style="list-style-type: none"> <li>- Climb to the cleared level and comply with published level restrictions</li> <li>- Follow the lateral profile of the SID</li> <li>- Published speed restrictions are cancelled at the specified point(s)</li> </ul>                |
| CLIMB UNRESTRICTED TO <i>(level)</i> or CLIMB TO <i>(level)</i> , CANCEL LEVEL AND SPEED RESTRICTION(S) | <ul style="list-style-type: none"> <li>- Climb to the cleared level, published level restrictions are cancelled</li> <li>- Follow the lateral profile of the SID</li> <li>- Published speed restrictions and ATC-issued speed control instructions are cancelled</li> </ul> |
| <b>Note:</b> Comply with published speed restrictions or ATC-issued speed control instructions.         |   |

**5.26. Military SID.** Military SIDs within the NAS may have some obstacles charted to scale and provide a table with climb rate information ([Figure 5.20](#)). Obstacle clearance climb rates may be denoted with an asterisk (\*) while ATC climb rates may be denoted with a dagger (†). Pilots should assume a climb rate is an obstacle clearance climb rate if only one climb rate is given. The climb rates published are given in vertical velocities for specific groundspeeds.

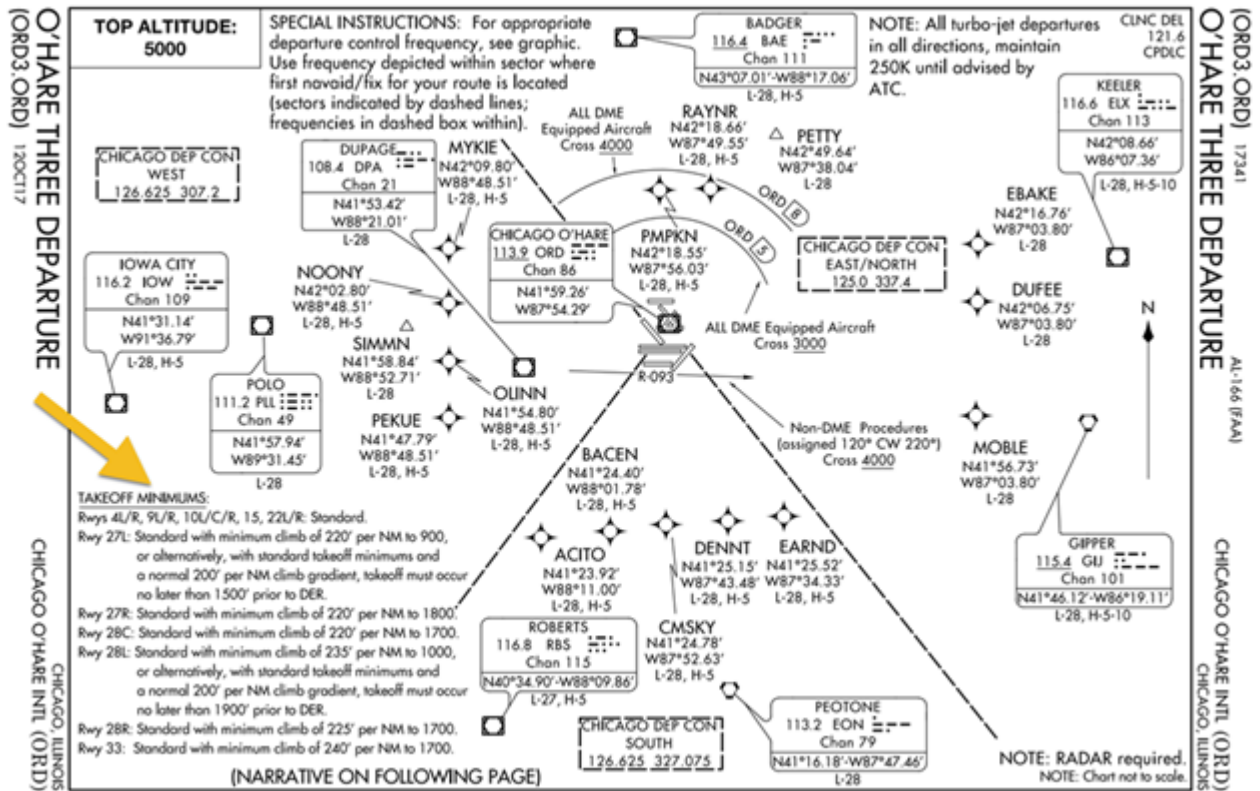
Figure 5.20. Military SID.



**5.27. Civil SID.** Obstacle climb gradients higher than the standard IFR departure climb gradient are published directly on a civil SID (Figure 5.21). USA SIDs are produced by the FAA within the NAS and should be treated as civil SIDs. Civil SIDs may list takeoff obstacle notes (i.e., low close-in obstacles) textually, but do not depict any obstacles graphically. **Note:** The FAA is removing takeoff obstacle notes from civil SIDs; eventually, takeoff obstacles may be found only in the “Trouble T” section of the terminal procedures publication.



Figure 5.21. Civil SID.



**5.28. ICAO SID.** [ICAO Doc 8168 Volume 1, Part I, Section 3, Chapter 2] PANS-OPS uses the term “SID” to refer to departures using track guidance. When a departure requires a turn of more than 15 degrees of the runway heading the departure is considered a “turning departure.” Turning departures are designed with standard speed limits to stay within protected airspace (Table 5.6). The procedure designer may restrict the SID either by aircraft category or by airspeeds if unable to provide obstacle clearance. **Note:** ICAO SIDs may not have an obstacle associated with them (i.e., preferred ATC departures).

Table 5.6. ICAO Maximum Speeds for “Turning Departures”.

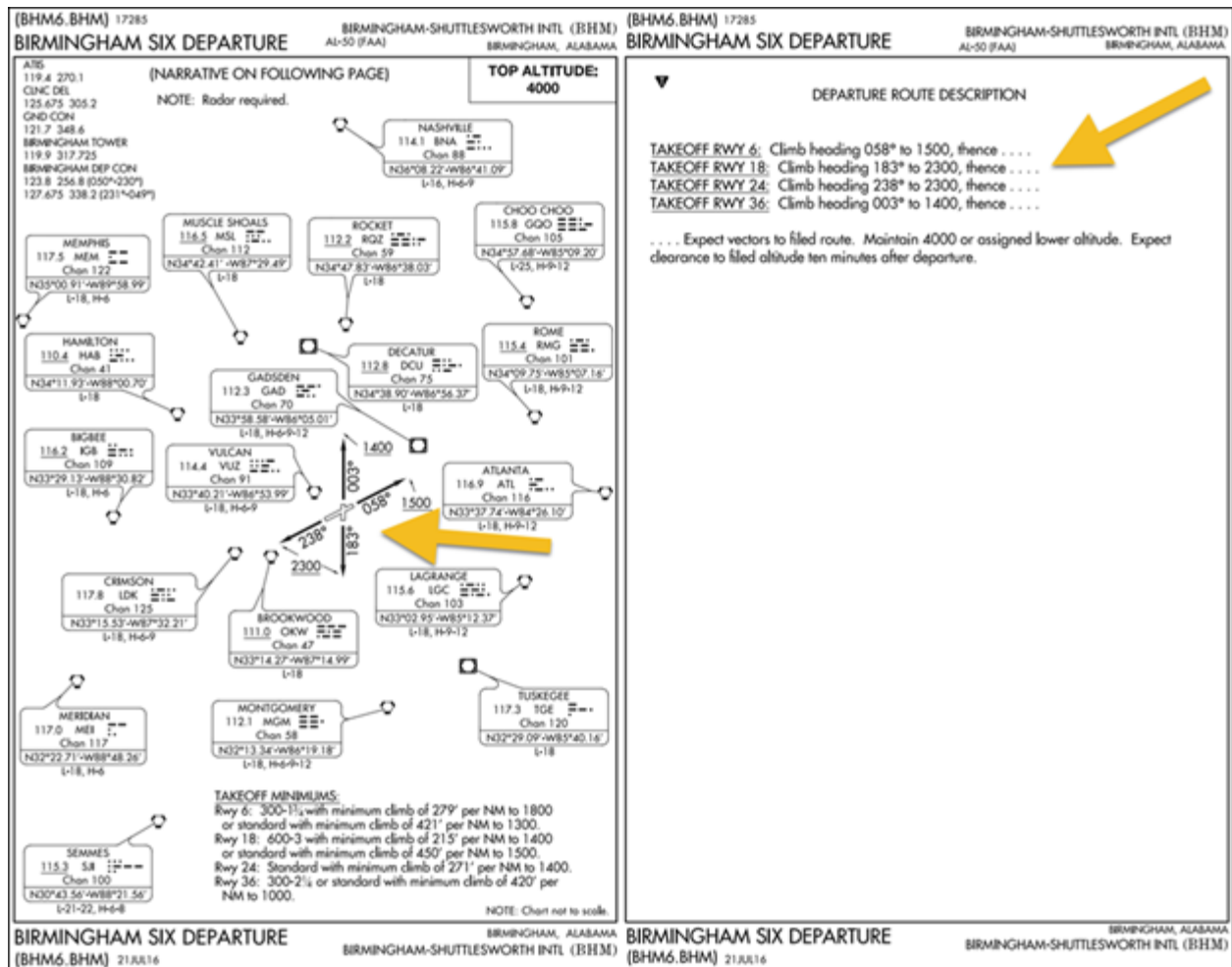
| Airplane category | Maximum speed (knots) |
|-------------------|-----------------------|
| A                 | 120                   |
| B                 | 165                   |
| C                 | 265                   |
| D                 | 290                   |
| E                 | 300                   |
| H                 | 90                    |

**Table 5.7. (Added-AFMC) Departure Minimums and Departure Alternate Requirements for Tanker/Transport/Bomber Aircraft.**

| <b>If departure weather is:</b>  | <b>A departure alternate is:</b> |
|--|----------------------------------|
| At or above authorized ceiling and visibility landing minimums.  | Not required.                    |
| Below either authorized ceiling or visibility minimums but RVR is 1600 or greater (visibility ¼ mile or greater)<br><b>-OR-</b><br>Below either authorized ceiling or visibility minimums but RVR is 1200 or greater at the approach end and 1000 or greater at the departure end and runway centerline lights operational. (See Note 3)   | Required.<br>(See Notes 1 and 2) |
| <p><b>NOTES:</b></p> <p>1. Departure alternate must be located within 30 minutes flight time with weather reported and forecast at or above approach minimums or 200- ½ (RVR 2400), whichever is higher, for 1 hour after takeoff.</p> <p><b>-OR-</b></p> <p>Departure alternate must be located within 2 hours flight time with weather forecast to be at least 500-1 above approach minimums but no lower than 700-2 for a precision approach or 800-2 for a non-precision approach for ETA at the alternate +/- one hour.</p> <p>2. Aircraft must be able to maintain minimum enroute altitude to the alternate if an engine fails.</p> <p>3. Must have centerline lighting and dual RVR display slave readouts for both approach and departure ends of the runway. For runways with triple RVR readouts, the pilot may use any two consecutive readouts to determine if the runway is usable for departure (aircraft performance permitting). For example, approach end RVR=800, midfield RVR=1700, departure end RVR=1000. If aircraft performance and runway length will permit taking off at midfield, this runway is usable for takeoff.</p> |                                  |

**5.29. Vector SID.** Vector SIDs are established where ATC provides radar navigation guidance to a filed route, assigned route, or to a fix depicted on the SID. Typically, a vector SID depicts only area NAVAIDs or fixes with simple departure instructions (**Figure 5.22**). **Note:** The heavy black line on a vector SID depicts runway heading and not a desired ground track.

Figure 5.22. Radar Vector SID.



### 5.30. MAJCOM-Certified Departure.

5.30.1. In restricted areas or during contingency operations, MAJCOMs may develop and authorize departure procedures (MAJCOM-certified procedures). These procedures are for specific aircraft at specific locations in accordance with AFMAN 11-230, *Instrument Procedures*. Aircrew will complete MAJCOM-specific training before using such procedures. (T-1).

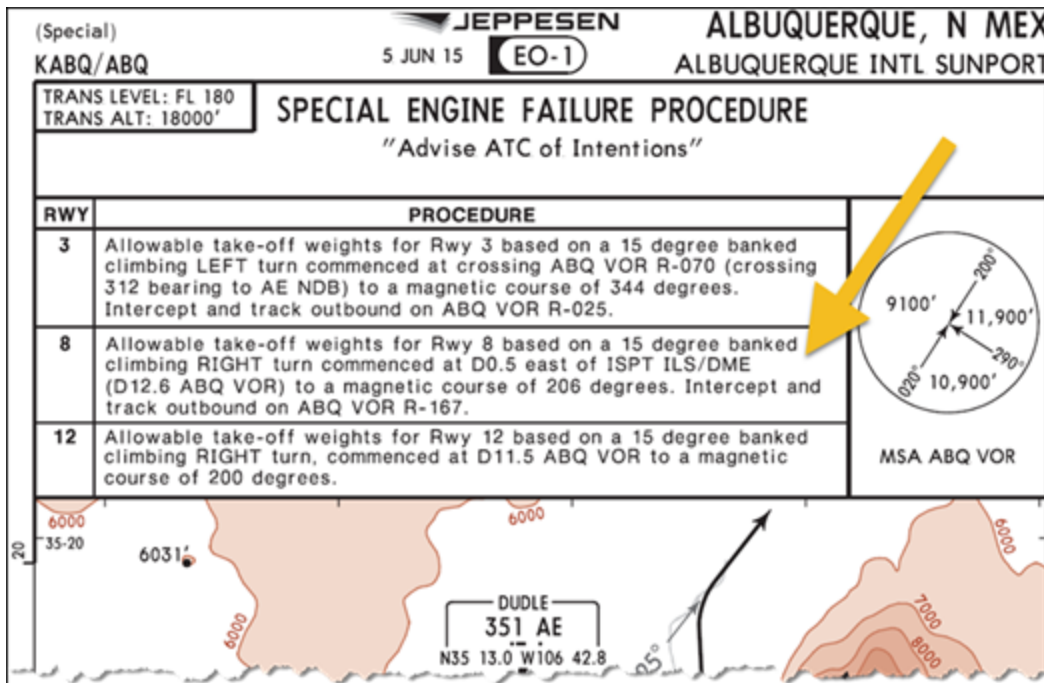
**5.31. Special Departure Procedure (SDP).** SDPs are aircraft-specific commercially designed and published procedures that require MAJCOM training and certification before use. SDPs can be useful for multi-engine aircraft by allowing an increased takeoff gross weight while providing escape routing in the event the aircraft loses thrust on takeoff. Notice how the SDP routing differs from the ODP routing (Figure 5.23 and Figure 5.24).



Figure 5.23. Albuquerque ODP (Runway 8).

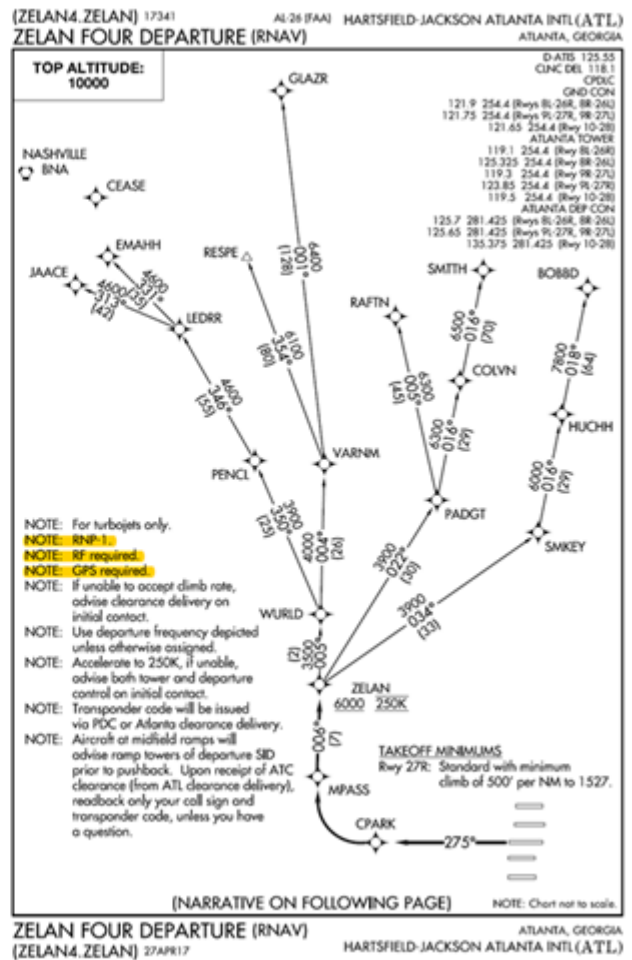
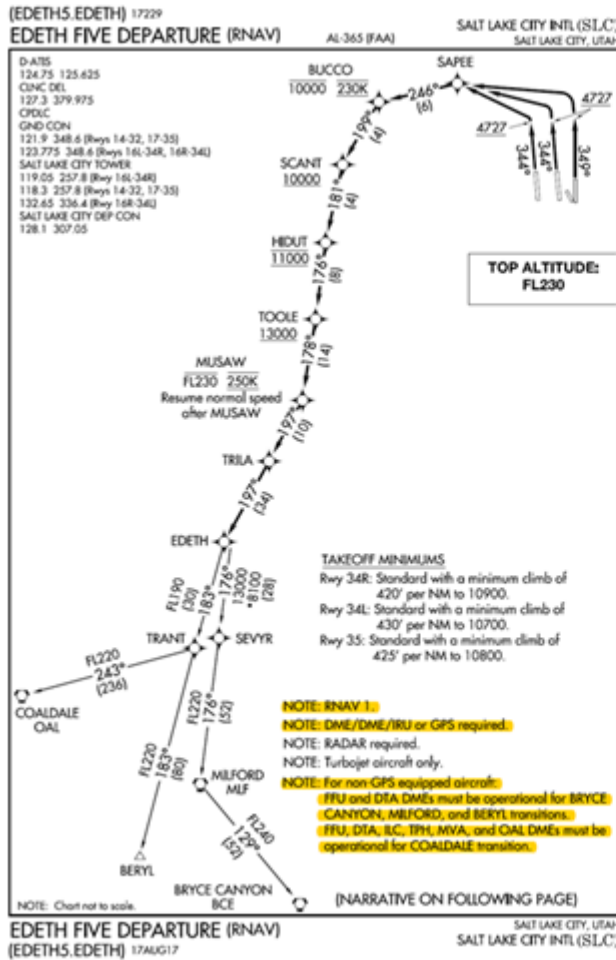
ALBUQUERQUE INTL SUNPORT (ABQ)  
 TAKEOFF MINIMUMS AND (OBSTACLE)  
 DEPARTURE PROCEDURES  
 AMDT 7 14149 (FAA)  
 TAKEOFF MINIMUMS: **Rwy 8**, std. w/min. climb of 515' per NM to 7800.  
 DEPARTURE PROCEDURE: **Rwys 3, 30**, climbing left turn flight. **Rwy 8**, climbing right turn direct ABQ VORTAC. If required, continue climb in ABQ VORTAC holding pattern (hold W, left turns, 077° inbound) to cross ABQ VORTAC at or above MEA/MCA for route of flight. (Do not exceed 250 KTS until ABQ VORTAC). **Rwys 12, 21**, climbing right turn direct ABQ VORTAC. If required, continue climb in

Figure 5.24. Albuquerque SDP (Runway 8).



**5.32. RNAV Departures.** [FAA Order 8260.46; AIM 5-1-16; AIM 5-5-16] RNAV departures may be RNAV 1 or RNP 1 (Figure 5.25). The default specification is RNAV 1; RNP 1 is used when a departure contains a radius-to-fix (RF) leg or for DME/DME/IRU aircraft use when radar monitoring is not desired. **Note:** The required specification, equipment sensor limitations, and any critical DME facilities are annotated clearly on the procedure.

Figure 5.25. RNAV Departure Procedures.



## Chapter 6

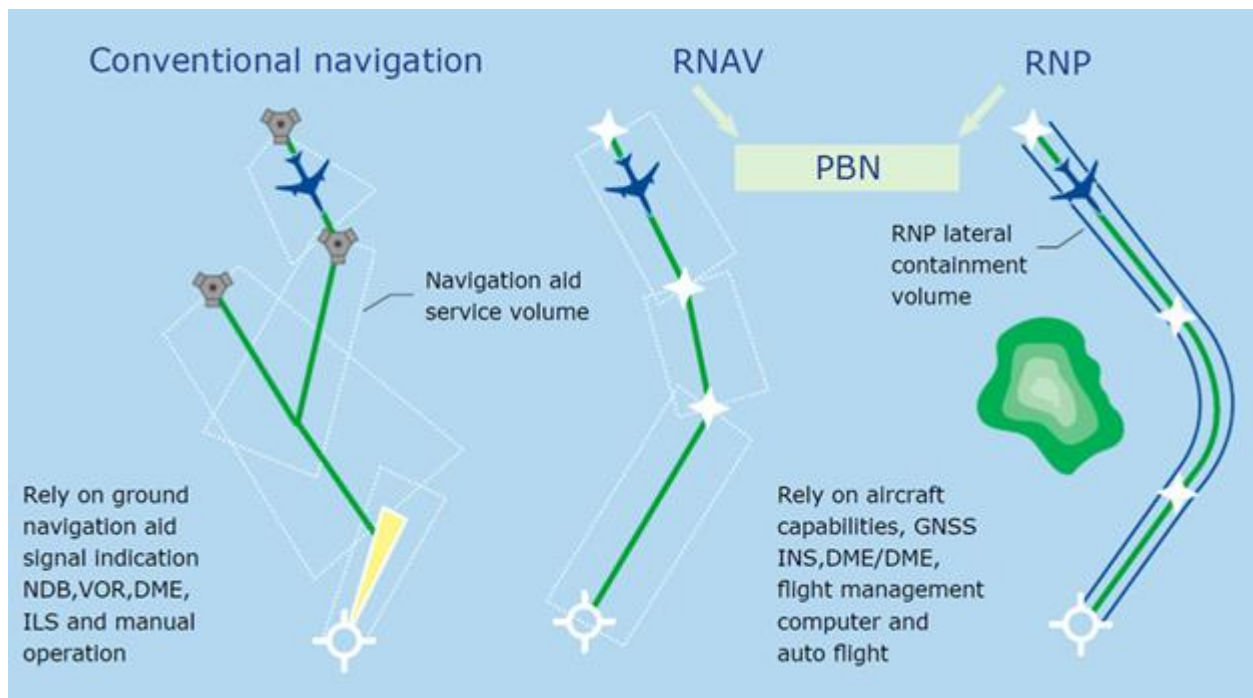
### PERFORMANCE-BASED NAVIGATION

**6.1. General.** [ICAO Doc 9613; AC 90-105; AIM 1-2-2] The performance-based navigation (PBN) concept specifies that aircraft area navigation and required navigation performance (RNP) system performance requirements be defined in terms of the accuracy, integrity, continuity and functionality needed for operations in a defined airspace (**Figure 6.1**). It represents a shift from sensor-based navigation (i.e., the navigation source, such as TACAN, is specified) to performance-based navigation (i.e., the required performance level is specified).

6.1.1. Two fundamental aspects of any PBN operation are the requirements set out in the appropriate navigation specification and the NAVAID infrastructure (both ground-based and space-based) allowing the system to operate.

6.1.2. Navigation specifications identify the choice of sensors and equipment that may be used to meet performance requirements. These navigation specifications are defined at a sufficient level of detail to facilitate global harmonization by providing specific implementation guidance.

**Figure 6.1. Progression from Sensor-based to Performance-based Navigation.**



**6.2. Area Navigation (RNAV) Operations and RNP Operations.** [AIM 1-2-1 through AIM 1-2-4; AIM 5-1-16; AIM 5-5-16] MAJCOMs will provide aircrew training, ensure aircraft certification, and grant operational approval for RNAV operations and RNP operations.

**6.2. (AFMC) Area Navigation (RNAV) Operations and RNP Operations.** Refer to AFMC/A3V SharePoint for the current MDS specific CNS/ATM certifications.

**6.3. PBN Context.** PBN is one of several enablers of an airspace concept. Communications, ATS surveillance, and air traffic management are also essential elements of an airspace concept.

6.3.1. PBN relies on area navigation and includes three components:

- 6.3.1.1. The NAVAID infrastructure;
- 6.3.1.2. The navigation specification; and
- 6.3.1.3. The navigation application.

6.3.2. The navigation application results from applying the NAVAID infrastructure and navigation specification to routes and instrument procedures within an airspace concept.

**6.4. Fundamental PBN Concepts.** The following concepts are fundamental to a solid understanding of PBN:

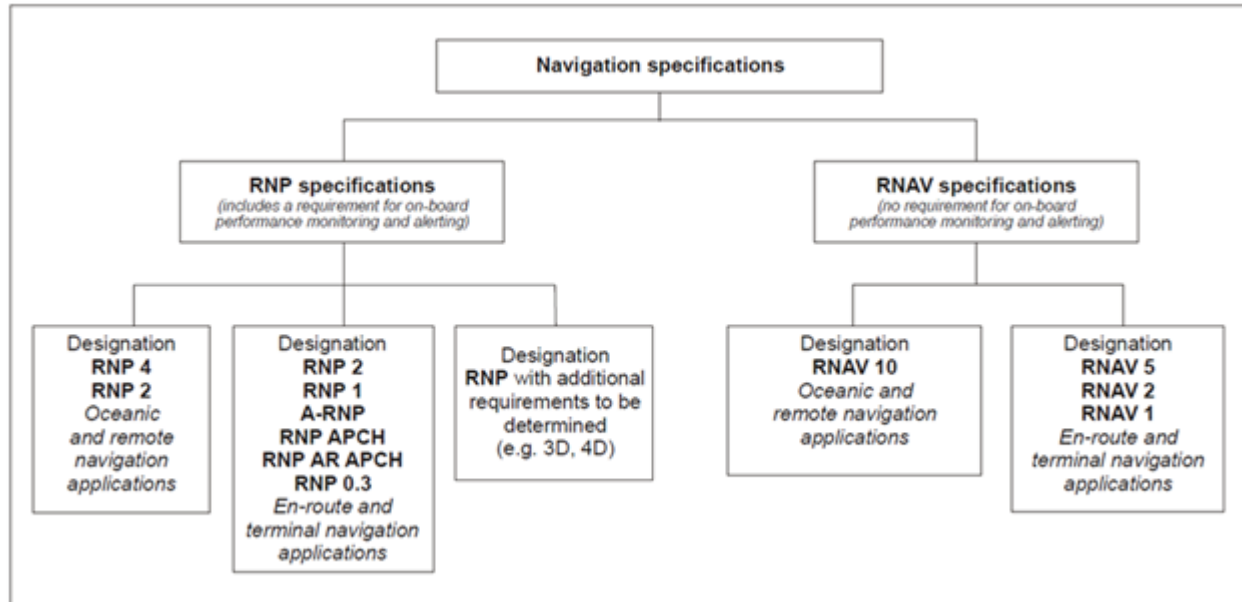
6.4.1. RNAV specification – a navigation specification based on area navigation that does not include the requirement for on-board performance monitoring and alerting, designated by the prefix “RNAV” (e.g., RNAV 5, RNAV 1).

6.4.2. RNP specification – a navigation specification based on area navigation that includes the requirement for on-board performance monitoring and alerting, designated by the prefix “RNP” (e.g., RNP 4, RNP 0.3).

**6.5. Navigation Functional Requirements.** Both RNAV specifications and RNP specifications include requirements for certain navigation functionalities. More sophisticated navigation specifications include the requirement for navigation databases and the capability to execute database procedures. At the basic level, these functional requirements may include:

- 6.5.1. Continuous indication of aircraft position relative to track displayed to the pilot flying on a navigation display situated in the primary field of view;
- 6.5.2. Display of distance and bearing to the active TO waypoint;
- 6.5.3. Display of ground speed or time to the active TO waypoint;
- 6.5.4. Navigation data storage function; and
- 6.5.5. Failure indication of the RNAV system or RNP system, including the sensors.

**6.6. Designation of RNAV Specifications and RNP Specifications.** “RNP X” designates an RNP specification (e.g., RNP 4); “RNAV X” designates an RNAV specification (e.g., RNAV 1). A prefix is used without a suffix where a navigation specification covers various phases of flight and permits different lateral navigation (LNAV) accuracy during various flight phases (e.g., A-RNP) (**Figure 6.2**). **Note:** “RNP APCH” and “RNP AR APCH” are the designations for approaches that use RNP specifications. See **paragraph 6.6.1**.

**Figure 6.2. Navigation Specification Designations.**

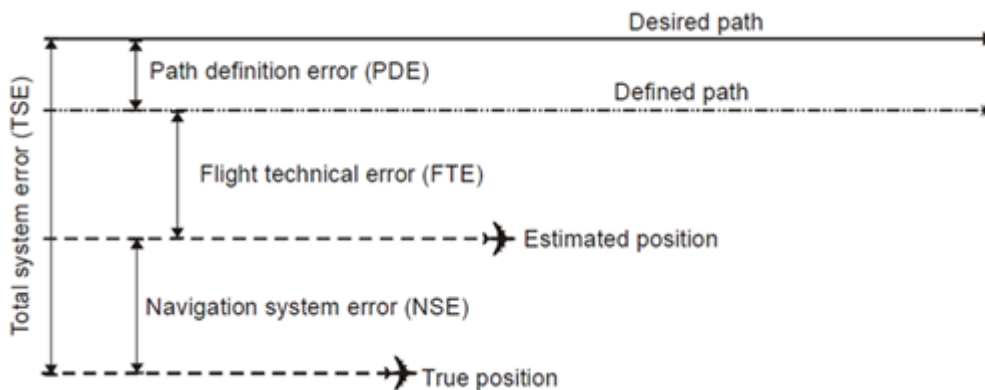
6.6.1. For RNAV designations and RNP designations, the “X” refers to the LNAV accuracy, or total system error (TSE), in nautical miles, expected to be achieved at least 95% of the flight time by the aircraft operating within the airspace, route, or procedure (**Figure 6.3**). TSE is composed of:

6.6.1.1. **Path definition error (PDE)**. PDE is the difference between the defined path on a navigation system and the desired path at a specific point. PDE is considered negligible due to the database integrity process.

6.6.1.2. **Flight technical error (FTE)**. FTE is the accuracy with which the aircraft is controlled as measured by the indicated aircraft position with respect to the indicated command or desired position. This functions as a combination of aircraft performance and the aircrew flying. It does not include pilot errors.

6.6.1.3. **Navigation system error (NSE)**. NSE is the difference between true position and estimated position. NSE is contained through integrity monitoring within the system itself. The NSE is largely independent of the aircraft on which the system is installed. **Note:** In sensor-based navigation, the NSE and PDE were built into the design; therefore, aircrew focused on resolving FTE only. In contrast to sensor-based navigation, PBN can now specifically target the NSE.



**Figure 6.3. Lateral Navigation Errors.**

6.6.2. Approach navigation specifications cover all segments of the instrument approach. RNP specifications are designated using RNP as a prefix and an abbreviated textual suffix (e.g., RNP APCH or RNP AR APCH). **Note:** Conventional approaches with PBN segments may include RNAV specifications or RNP specifications specific to defined segments of the approach.

6.6.2.1. ICAO is currently working to harmonize the naming convention for PBN IAPs. The ICAO RNP APCH navigation specification is currently identified by “RNAV (GNSS) RWY XX”. In the future, this specification will be identified by “RNP RWY XX”. The ICAO RNP AR APCH navigation specification is currently identified by “RNAV (RNP) RWY XX”. In the future, this specification will be identified by “RNP RWY XX (AR)”.

6.6.2.2. [NAS Only] “RNAV (GPS)” is equivalent to the ICAO designation “RNP APCH”.

6.6.2.3. [NAS Only] “RNAV (RNP)” is equivalent to the ICAO designation “RNP AR APCH”.

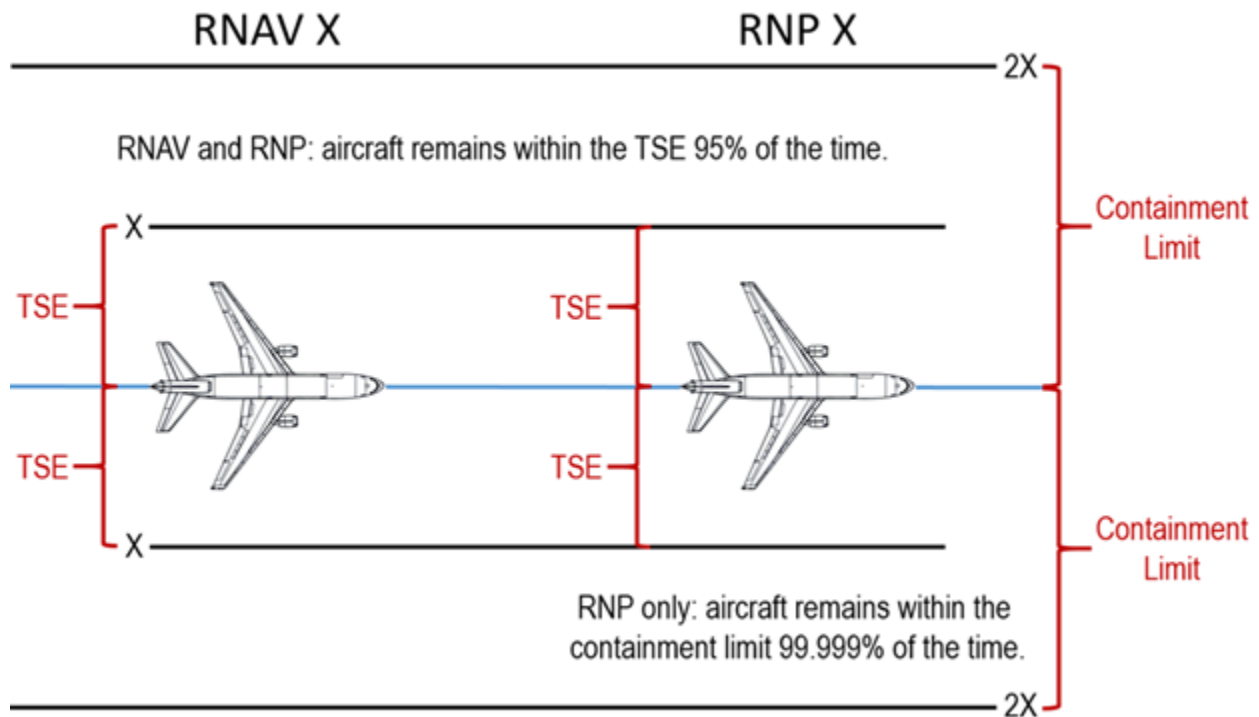
**6.7. RNAV Designations and RNP Designations.** In cases where navigation accuracy is used as part of the designation of a navigation specification, it is only one of the functional and performance requirements included in a navigation specification ([Figure 6.4](#)).

6.7.1. Functional and performance requirements are defined for each navigation specification; therefore, an aircraft approved for an RNP specification is not automatically approved for all RNAV specifications.

6.7.2. Similarly, an aircraft approved for an RNAV specification or RNP specification having a stringent accuracy requirement (e.g., RNP 0.3) is not automatically approved for a navigation specification having a less stringent accuracy requirement (e.g., RNP 1, RNP 4).

6.7.3. It may seem logical, for example, that an aircraft approved for RNP 1 be automatically approved for RNP 4; however, this is not the case. Aircraft approved to the more stringent accuracy requirements may not necessarily meet some of the functional requirements of the navigation specification having a less stringent accuracy requirement.

Figure 6.4. RNAV Designations vs RNP Designations.



**6.8. On-board Performance Monitoring and Alerting.** On-board performance monitoring and alerting is the main element that determines if the navigation system complies with the necessary safety level associated with an RNP application (versus an RNAV application). Additionally, it determines if the navigation system relates to lateral and longitudinal navigation performance. Finally, it determines if the navigation system allows the aircrew to detect that the navigation system is not achieving or cannot guarantee the navigation performance required with 10-5 integrity (i.e., less than a 0.001% chance).

6.8.1. RNP systems provide improvements on the integrity of operations; this may permit closer route spacing and can provide sufficient integrity to allow only RNP systems to be used for navigation in a specific airspace. The use of RNP systems may therefore offer significant safety, operational, and efficiency benefits over RNAV systems.

6.8.2. Both RNAV systems and RNP systems are required to meet an accuracy requirement 95% of the time (i.e., with a 95% confidence). Normally, RNAV systems do not include on-board performance monitoring and alerting; aircrew will monitor a lateral deviation display (e.g., CDI) for course errors. **(T-0)**.

6.8.3. RNP systems are required to alert the aircrew if the accuracy requirement is not met or the probability that lateral TSE exceeds 2X is greater than 10-5 (i.e., the performance monitoring and alerting requirement contains the aircraft within 2X at a 99.999% level of confidence). Compliance with the performance monitoring and alerting requirement does not imply automatic monitoring of FTE. Therefore, the on-board monitoring and alerting function should consist of at least an NSE monitoring and alerting algorithm and a lateral deviation display enabling the crew to monitor the FTE.

## Chapter 7

### PERFORMANCE-BASED COMMUNICATION AND SURVEILLANCE

**7.1. General.** [ICAO Doc 9869, *Performance-based Communication and Surveillance (PBCS) Manual*; AC 90-117] The performance-based communication and surveillance (PBCS) concept provides objective operational criteria to evaluate different and emerging communication and surveillance technologies intended for evolving air traffic management (ATM) operations.

**7.2. PBCS Operations.** MAJCOMs will train aircrews, certify aircraft PBCS systems, and grant operational approval prior to use for PBCS operations. **Note:** This requirement does not prohibit aircrews from operating in airspace where PBCS is implemented; however, such aircraft would not be eligible for reduced separation minima requiring PBCS capability (e.g., North Atlantic High Level Airspace).

**7.2. (AFMC) PBCS Operations.** Refer to AFMC/A3V SharePoint for the current MDS specific CNS/ATM certifications.

**7.3. PBCS Context.** The PBCS concept is aligned with that of PBN ([Figure 7.1](#)). While the PBN concept applies RNAV specifications and RNP specifications to the navigation element, the PBCS concept applies required communication performance (RCP) and required surveillance performance (RSP) specifications to communication and surveillance elements, respectively. Each RCP or RSP specification includes allocated criteria among the components of the communication and surveillance systems involved.

**Figure 7.1. Performance-based ATM Model.**



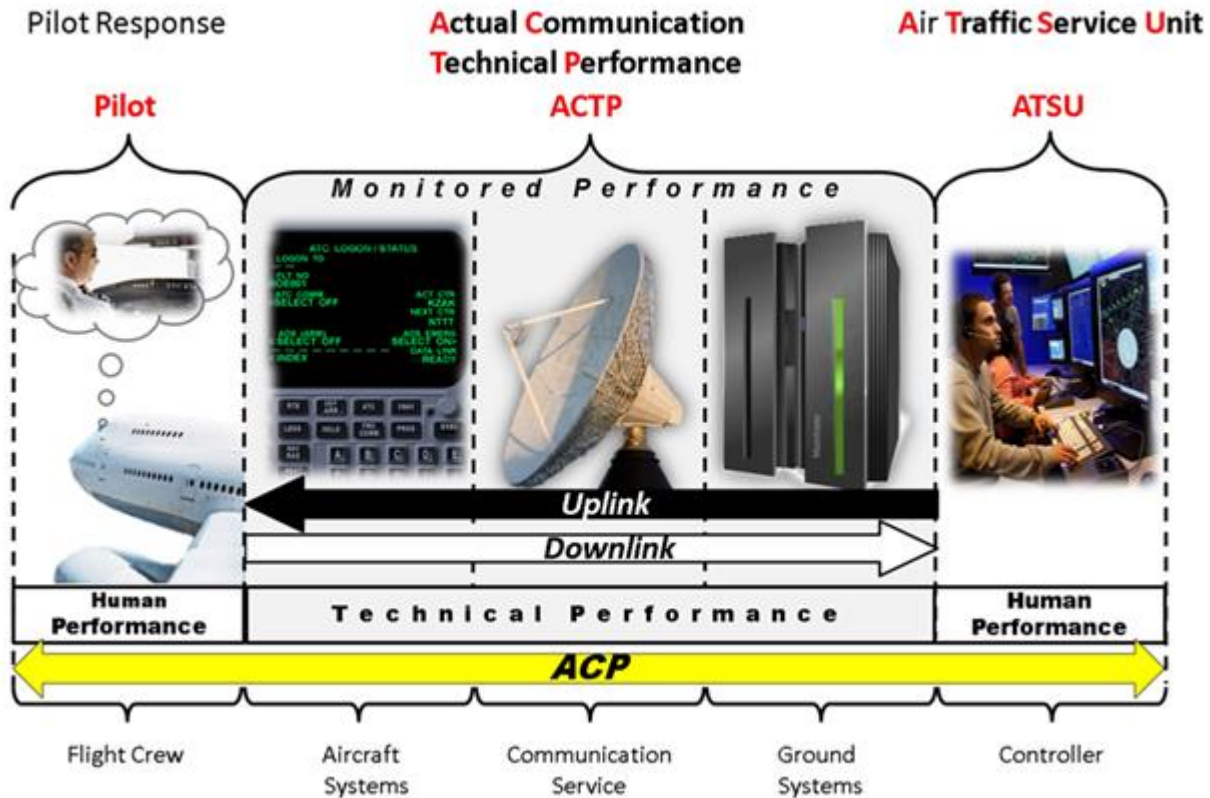
**7.4. RCP Specifications.** An RCP specification represents operational parameters for the complete communication transaction. "RCP X" designates an RCP specification and makes RCP expiration time clear to airspace planners, aircraft manufacturers, and operators (e.g., RCP 240).



RCP specifications are applied to achieve required communication performance and may support specific aircraft separation minima.

**7.5. Actual Communication Performance (ACP).** ACP is the combined uplink and downlink performance of ground systems, communication service, and aircraft systems (Figure 7.2). ACP is an indicator of the operational performance of a communication system which includes human and technical components.

**Figure 7.2. Actual Communications Performance (ACP).**



**7.6. RSP Specifications.** An RSP specification represents operational parameters for the complete surveillance transaction. “RSP X” designates an RSP specification and makes RSP overdue delivery time clear to airspace planners, aircraft manufacturers, and operators (e.g., RSP 180). RSP specifications are applied to airspace based on specific objectives (e.g., the surveillance performance required to support specific separation minima).

## Chapter 8

### GROUND-BASED NAVIGATION AIDS

**8.1. General.** Various NAVAIDs are in use today, each serving a specific purpose. This chapter builds on the concepts introduced in FAA handbooks and manuals.

8.1.1. Refer to AIM 1-1-1 through AIM 1-1-20 for basic NAVAID information.

8.1.2. Additional detailed information may be found in FAA-H-8083-15, FAA-H-8083-16, and FAA-H-8083-25.

**8.2. Reporting Malfunctions.** [AIM 1-1-13] Pilots should notify ATC of any NAVAID malfunction or deteriorating performance.

#### **8.3. Using Ground-based NAVAIDs.**

8.3.1. Tune the desired frequency or channel.

8.3.2. Identify the NAVAID via aural (Morse code) or visual (alphanumeric) signal.

8.3.3. Monitor the station identification (either aural or visual) to ensure the transmission of a reliable signal.

8.3.3.1. Removal of station identification warns pilots that the facility is officially off the air for tune-up or repairs and may be unreliable even though signals are received.

8.3.3.2. There is a direct correlation between the strength of an NDB identifier and the strength and reliability of its signal; there are no off flags to indicate loss of signal. Therefore, monitor the NDB for the entire procedure when procedures require an NDB.

8.3.4. Select proper position for the navigation system switches.

8.3.5. Display the desired information on the navigation instruments.

8.3.6. Check the appropriate instrument indicators for proper operation.

**8.4. VOR Minimum Operational Network (MON).** [AIM 1-1-3] The FAA plans to remove selected VORs from service as flight procedures and the enroute structure are gradually being replaced with PBN procedures.

8.4.1. PBN procedures are primarily reliant on GNSS. Aircraft equipped with DME/DME systems may continue flying PBN procedures during a GNSS disruption.

8.4.2. The FAA plans to retain a limited network of VORs for aircraft not equipped with a DME/DME system; the MON provides basic navigation service for these aircraft if GNSS becomes unavailable. During a GNSS disruption, the MON enables aircraft to navigate through the affected area or to a safe landing at an airfield without reliance on GNSS.

8.4.3. Navigation using the MON may not be as efficient as the new PBN route structure; however, use of the MON should provide nearly continuous VOR signal coverage at 5,000 feet above ground level (AGL) across the NAS, outside of the western U.S. mountainous area.

**8.5. TACAN.** A TACAN consists of a rotating antenna for transmitting azimuth information and a receiver-transmitter for transmitting range information. Aircrew will not navigate using a TACAN unless valid azimuth and range information are available (i.e., a TACAN broadcasting

range with no valid azimuth or a TACAN broadcasting azimuth with no valid range must be considered unusable). (T-0).

8.5.1. Like the VOR, the receipt of a TACAN signal is dependent on the line-of-sight principle. Therefore, aircraft altitude, distance from station, terrain and obstructions are principal factors that affect TACAN signals.

8.5.2. The TACAN may also have an “X” or “Y” setting. Pilots may assume the TACAN is set to “X” unless the letter “Y” appears in parenthesis after the TACAN frequency.

8.5.3. The ground equipment responsible for providing DME is only capable of responding to 100 simultaneous interrogations before saturation occurs. TACANs are designed to disregard weaker signals when more than 100 DME interrogations are received.

**8.6. Instrument Landing System (ILS).** [ICAO Annex 10 Volume 1] ICAO PANS-OPS criteria defines the standard service volume for a localizer (LOC) as 25 nautical miles within 10 degrees of the front course centerline, 17 nautical miles between 10 degrees and 35 degrees of the front course centerline, and 10 nautical miles outside of 35 degrees from the front course centerline.

8.6.1. Where topographical features dictate, or operational requirements permit, this service volume may be reduced to 18 nautical miles within the 10-degree sector and 10 nautical miles for the remainder of the coverage when alternative navigation means provide satisfactory coverage within the intermediate approach area.

8.6.2. [NAS Only] FAA criteria defines the standard service volume for a localizer in accordance with the reduced localizer service volume of 18 nautical miles within the 10-degree sector and 10 nautical miles for the remainder of the coverage [AIM 1-1-9].

**8.7. Localizer (LOC).** [ICAO Annex 10 Volume 1] The ICAO abbreviation for a localizer facility on an instrument procedure is “LLZ”; however, the abbreviation “LOC” may also be used. ICAO PANS-OPS criteria require localizer final approach track alignment within 5 degrees of runway centerline; U.S. TERPS criteria requires localizer final approach track within 3 degrees of runway centerline.

8.7.1. A localizer offset more than 5 degrees from runway centerline is considered an instrument guidance system.

8.7.2. [NAS Only] A localizer offset more than 3 degrees from runway centerline is considered a localizer type directional aid (LDA) [FAA Order 6750.24, *Instrument Landing System and Ancillary Electronic Component Configuration and Performance Requirements*].

## Chapter 9

### SPACE-BASED NAVIGATION AIDS

**9.1. General.** [ICAO Doc 9849; AIM 1-1-18] The term GNSS refers to any satellite constellation that provides positioning, navigation, and timing services. Theoretically, a GNSS receiver can calculate its three-dimensional position by knowing its range from three satellites if the receiver clock is perfectly synchronized with the satellite clocks. In practice, the GNSS receiver calculates the “pseudo-range” to at least four satellites and their positions to calculate the clock offset via the pseudo-range of the fourth satellite.

9.1.1. There are only two fully operational GNSS constellations providing global services: the U.S. global positioning system (GPS) and the Russian Federation *globalnaya navigazionnaya sputnikovaya sistema* (GLONASS).

9.1.1.1. The European Union (EU) Galileo constellation currently includes 17 operational satellites and 5 satellites under commissioning.

9.1.1.2. The Chinese BeiDou navigation satellite system (BDS) constellation currently has 15 operational satellites in orbit.

9.1.2. GNSS constellations are not necessarily interoperable; therefore, GNSS receivers require specific hardware to receive, decode, and use services from each constellation.

9.1.3. GNSS navigation is referenced to the World Geodetic System 1984 (WGS-84) coordinate system. GNSS-based navigation should only be used where the ICAO State conforms to WGS-84 or equivalent systems.

**9.2. Reporting Malfunctions.** [AIM 1-1-13] Pilots should notify ATC of any GNSS malfunction or deteriorating performance. Additionally, GNSS problems should be reported via the FAA’s *GPS Anomaly Reporting Form* at [http://www.faa.gov/air\\_traffic/nas/gps\\_reports/](http://www.faa.gov/air_traffic/nas/gps_reports/).

**9.3. Global Positioning System (GPS).** The USAF operates GPS for the U.S. Government. In 2007, the U.S. Government re-committed to providing GPS signals on a continuous worldwide basis in support of international civil aviation. The nominal GPS space segment is comprised of 24 operational satellites in orbit.

9.3.1. The GPS navigation message contains three major components. The first contains the GPS date and time, the satellite’s status, and an indication of its health. The second contains orbital information that allows the receiver to calculate the position of the satellite. The third, called the almanac, provides the locations and pseudo-random noise codes of all the satellites, which allows the receiver to determine which satellites are in view. **Note:** The pseudo-random noise code is used to identify GPS satellites in the U.S. NOTAM system and many GPS receivers.

9.3.2. GPS status information is also available from the United States Coast Guard navigation information service: (703) 313-5907 or <http://www.navcen.uscg.gov/>. Additionally, satellite status is available through the NOTAM system via the DoD Aeronautical Information Portal (DAIP) website at <https://www.daip.jcs.mil/>. Pilots may retrieve GPS and WAAS NOTAMs by selecting “GPS/WAAS” under “Advanced Search” after logging in to DAIP.

**9.4. Globalnaya Navigazionnaya Sputnikovaya Sistema (GLONASS).** The Ministry of Defense of the Russian Federation operates GLONASS. The nominal GLONASS space segment consists of 24 operational satellites and several spares. A navigation message transmitted from each satellite consists of satellite coordinates, velocity and acceleration vector components, satellite health information, and corrections to GLONASS system time. The navigation message provides information regarding the status of the transmitting satellite along with information on the remainder of the constellation.

**9.5. Aircraft-based Augmentation System (ABAS).** ABAS is an avionics implementation that processes core constellation signals with information available on board the aircraft. Many ICAO States have taken advantage of GPS with ABAS to improve service without incurring any expenditure on infrastructure.

9.5.1. There are two general classes of integrity monitoring: RAIM, which uses GNSS information exclusively; and aircraft autonomous integrity monitoring, which also uses information from additional on-board sensors such as inertial reference units (IRU).

9.5.2. ABAS provides integrity monitoring using redundant range measurements to support fault detection (FD) or FDE. The purpose of FD is to detect a potential position error caused by a satellite exceeding its tolerances. Upon detection, the GNSS navigation function is lost. Avionics with FDE identify and exclude the faulty satellite, thereby allowing GNSS navigation to continue without interruption, provided that sufficient healthy satellites with good geometry remain in view.

**9.6. RAIM.** [ICAO Doc 9849; AIM 1-1-17] RAIM is a form of ABAS. RAIM requires at least five satellites with good geometry to detect a faulty signal and alert the aircrew; FDE requires six. The availability of RAIM and FDE is slightly lower for mid-latitude operations and slightly higher for equatorial and high-latitude operations due to the nature of core constellation orbits. The requirement for redundant signals means that navigation guidance with RAIM may not be available 100% of the time.

9.6.1. A barometric altimeter may be used to provide an additional measurement that reduces the number of satellites in view required by one for RAIM and FDE. Barometric aiding can also help to increase RAIM and FDE availability when there are enough visible satellites, but their geometry is not adequate to support the integrity function. **Note:** Barometric aiding is different from the Baro-VNAV function used to support some non-precision approaches with vertical guidance.

9.6.2. There are two types of RAIM alert: when there is poor satellite geometry, during which the ability to detect a failed satellite is lost, and when the RAIM algorithm detects a satellite fault, which results in the loss of GNSS navigation capability unless the receiver includes FDE.

9.6.3. Some ICAO States have approved the use of GNSS as the only navigation service in domestic airspace and in oceanic and remote areas; the avionics require FDE in these cases. Under such approvals, aircraft may require dual systems and pilots may be required to perform preflight predictions to make certain that enough satellites will be in view to support service throughout the flight.

9.6.4. Predictive RAIM information for the NAS may be obtained by contacting an FAA flight service station (FSS) or visiting the FAA RAIM Prediction Tool website at

<http://sapt.faa.gov/>. Within Europe, predictive RAIM information may be obtained by visiting the AUGUR GPS RAIM Prediction Tool website at <http://augur.eurocontrol.int/>.

**9.7. Satellite-Based Augmentation System (SBAS).** SBAS augments core satellite constellations by providing integrity and correction information; some systems also provide additional ranging signals. SBAS reference stations monitor core constellation satellite signals and continuously provide data to master stations. Master stations use these data to assess satellite signal validity and compute corrections to the broadcast orbital information and clock data for each satellite.

9.7.1. The GNSS SARPs allow for three levels of SBAS capability that provide:

9.7.1.1. Core satellite status and geostationary earth orbit (GEO) satellite ranging;

9.7.1.2. Clock and orbital information corrections; and

9.7.1.3. Clock, orbital information, and ionospheric corrections.

9.7.2. The first two levels support PBN enroute through non-precision approach operations; the third level also supports non-precision approach with vertical guidance operations.

**9.8. SBAS Avionics.** “SBAS receiver” designates GNSS avionics that meet the minimum requirements outlined in ICAO Annex 10 and relevant specifications, such as Technical Standard Order (TSO)-C145, *Airborne Navigation Sensors Using the Global Positioning System Augmented by The Satellite Based Augmentation System (SBAS) or TSO-C146a, Stand-Alone Airborne Navigation Equipment Using The Global Positioning System Augmented By the Satellite Based Augmentation System (SBAS)*.

9.8.1. There are four classes of SBAS avionics that support different performance capabilities. Class I equipment supports enroute, terminal, and LNAV approach operations. Class II equipment supports enroute, terminal, LNAV/vertical navigation (VNAV) approach operations, and LNAV approach operations. Class III and IV equipment support enroute, terminal, and four approach minima levels: LPV, localizer performance (LP), LNAV/VNAV, and LNAV.

9.8.2. SBAS avionics are required to announce the highest level of service supported by the combination of the SBAS signal integrity level and the receiver certification using the naming conventions on the approach procedure chart lines of minima. SBAS avionics support flying the complete procedure and can operate in a vector-to-final mode.

9.8.3. SBAS avionics may provide advisory vertical guidance when flying NDB or VOR approaches and GNSS non-precision approaches in areas where an SBAS supports this level of service, thus providing the benefits of a stabilized descent. In this case, the aircrew is responsible for complying with all minimum altitudes specified on the approach chart.

**9.9. SBAS Coverage and Service Areas.** GEO satellite footprints define the coverage area of an SBAS. Within this coverage area, ICAO States can establish service areas where SBAS supports approved operations. Other ICAO States within the coverage area could also establish service areas either by installing integrated reference and monitoring stations in cooperation with the SBAS provider or by approving the use of SBAS signals. An ICAO State that has established an SBAS service area is responsible for the SBAS signals within that service area.

9.9.1. Current SBAS implementations include the U.S. WAAS, European geostationary navigation overlay system (EGNOS), Indian GPS and geo-augmented navigation system (GAGAN), and the Japanese multi-function satellite augmentation system (MSAS).

9.9.1.1. WAAS, EGNOS, and GAGAN augment GPS but not GLONASS; they allow for LPV operations down to 200 feet HAT.

9.9.1.2. MSAS does not currently support LPV operations.

9.9.2. The Russian Federation is currently developing the system for differential corrections and monitoring (SDCM). SDCM is designed to provide corrections and integrity for GPS and GLONASS.

9.9.3. Although SBAS architectures are different, they broadcast an ICAO standard message format on the same frequency; they are interoperable from the aircraft perspective. When SBAS coverage areas overlap, it is possible for an SBAS operator to monitor and broadcast integrity and correction messages for the GEO satellites of another SBAS, thus improving availability by adding ranging sources.

9.9.4. SBAS coverage for the NAS may be obtained by visiting the FAA WAAS Performance website at <http://www.nstb.tc.faa.gov/>. SBAS coverage for Europe may be obtained by visiting the EGNOS User Support website at [https://egnos-user-support.essp-sas.eu/new\\_egnos\\_ops/](https://egnos-user-support.essp-sas.eu/new_egnos_ops/).

**9.10. Ground Based Augmentation System (GBAS).** A GBAS ground station is located at or near the airfield served. The ground station monitors core constellation signals and broadcasts locally relevant pseudo-range corrections, integrity parameters, and approach definition data to aircraft in the terminal area via a very high frequency (VHF) data broadcast (VDB). GBAS supports CAT I precision approaches; in the future GBAS may support CAT II and III precision approaches. **Note:** Some documents refer to local area augmentation system (LAAS) which is an outdated term for GBAS.

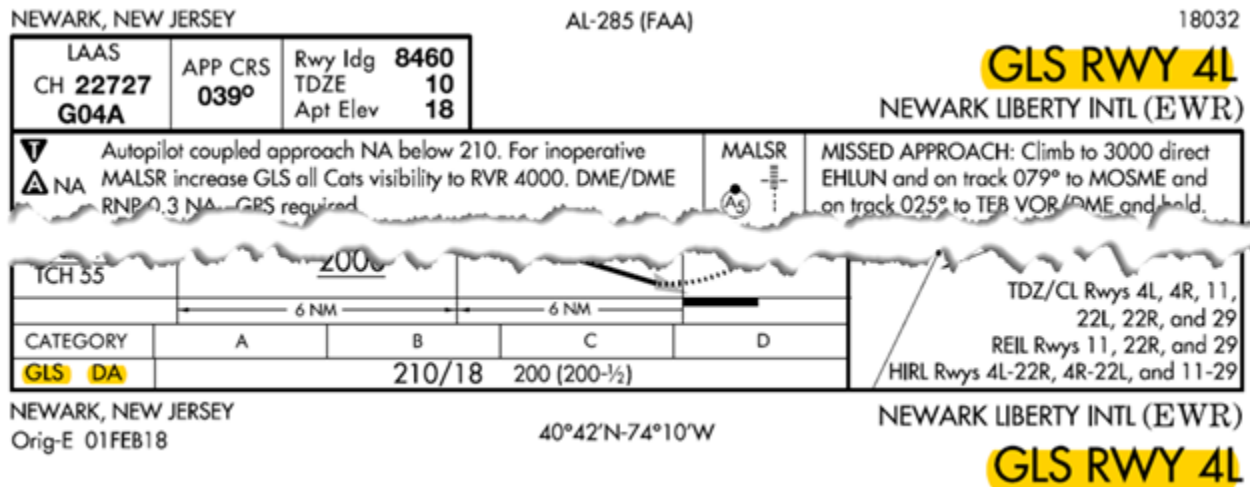
9.10.1. GBAS precision approach service provides lateral and vertical deviation guidance for the final approach segment. The optional GBAS positioning service supports two-dimensional PBN operations in terminal areas.

9.10.2. GBAS can provide multiple approaches to the same runway end with a unique channel number identifying each one. These approaches may have different glidepath angles or displaced thresholds.

9.10.3. The term “GBAS landing system (GLS)” is used in the charting of GBAS approaches, both for the chart title and the GBAS minima line (**Figure 9.1**).



Figure 9.1. GBAS Landing System (GLS) Approach.



**9.11. GBAS Avionics.** The term GBAS receiver designates the GNSS avionics that meet the minimum requirements for a GBAS receiver as outlined in ICAO Annex 10 and relevant specifications.

9.11.1. Like ILS, the GBAS receiver provides lateral and vertical guidance relative to the defined final approach course and glidepath. The receiver selects the VDB frequency and identifies the specific data block that defines the approach.

9.11.2. GBAS avionics standards mimic ILS to simplify the integration of GBAS with existing avionics. Display scaling and deviation outputs are equivalent to ILS to reduce aircrew training requirements. All avionics provide final approach course and glidepath guidance to all configurations of ground stations.



## Chapter 10

### INSTRUMENT CHARTS

**10.1. General.** The geographic location of the aircraft is the determining factor for which instrument chart procedural criteria to use unless local procedures detailed in FLIP or local directives are in place. If flying outside of the NAS, apply ICAO procedures unless otherwise published. **Note:** Host nation produced charts may not conform to the approved DoD charting specifications (i.e., missing obstructions, terrain or other foundational information) which may not provide adequate obstruction clearances. The nationality of ATC or the agency that produced a given procedure is not relevant.

10.1.1. A current copy of the appropriate instrument procedure chart will be available in the aircraft for the departure, destination, and all planned alternates. **(T-3).**

10.1.2. Instrument charts retrieved from MAJCOM-approved FAA or NGA electronic delivery systems are identical to those in the printed terminal procedures publication. Pilots will annotate the effective dates from the NGA ACES website banner on any printed or photocopied NGA instrument procedure. **(T-2).** **Note:** Comparing amendment numbers or Julian dates on new plates against previously printed plates is not a valid way of determining currency. Information on a plate can change without an amendment number or Julian date change.

10.1.3. Refer to the appropriate Terminal Change Notice on the front of the terminal procedures publication to ensure an instrument procedure is current when using NGA-printed products.

**10.2. Ground Track.** [ICAO Doc 8168 Volume 1, Section 2, Chapter 1] All instrument procedures are based on a ground track. Obstruction clearance assumes that pilots apply appropriate corrections to maintain the published path across the ground.

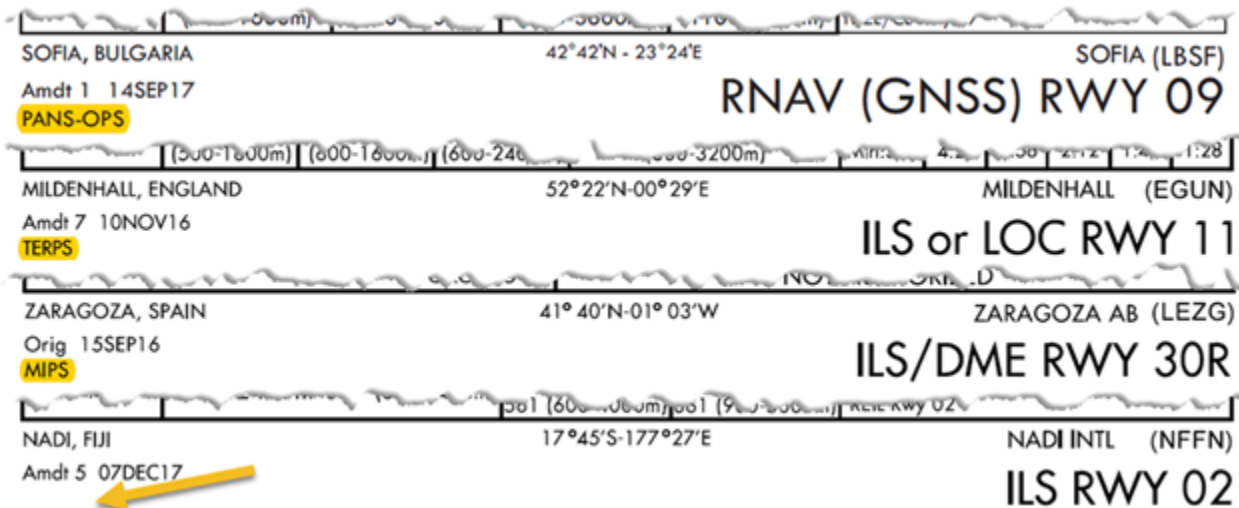
**10.3. Instrument Procedure Design Criteria.** [DoD Publication Product Specifications; FAA Order 8260.3] Knowing what design criteria was used to create an instrument procedure is essential to determining protected airspace requirements. Criteria used to develop published instrument procedures are not determined by the physical location of the airfield but by the protected airspace allowances used in the procedure design.

10.3.1. The U.S. Government applies U.S. TERPS design criteria within the United States and its territories in accordance with FAA Order 8260.3. A DoD or FAA designed terminal instrument procedure must pass through a stringent quality control process, culminating in a flight inspection, prior to being published in U.S. Government FLIP. **Note:** Outside the NAS, the USAF may apply U.S., ICAO, or North Atlantic Treaty Organization (NATO) Military Instrument Procedure Standardization (MIPS) design criteria as authorized by AFMAN 11-230, or as directed by the host nation.

10.3.2. Other ICAO States may use U.S. TERPS, ICAO PANS-OPS, NATO MIPS, their own criteria, or a combination of criteria when designing instrument procedures (e.g., Japan primarily uses ICAO PANS-OPS but publishes different circling area calculations). **Note:** NATO MIPS (i.e., NATO Standard Allied Air Traffic Control Publication (AATCP-1)) lists NATO supplemental procedures to ICAO PANS-OPS for instrument departure and approach procedures.

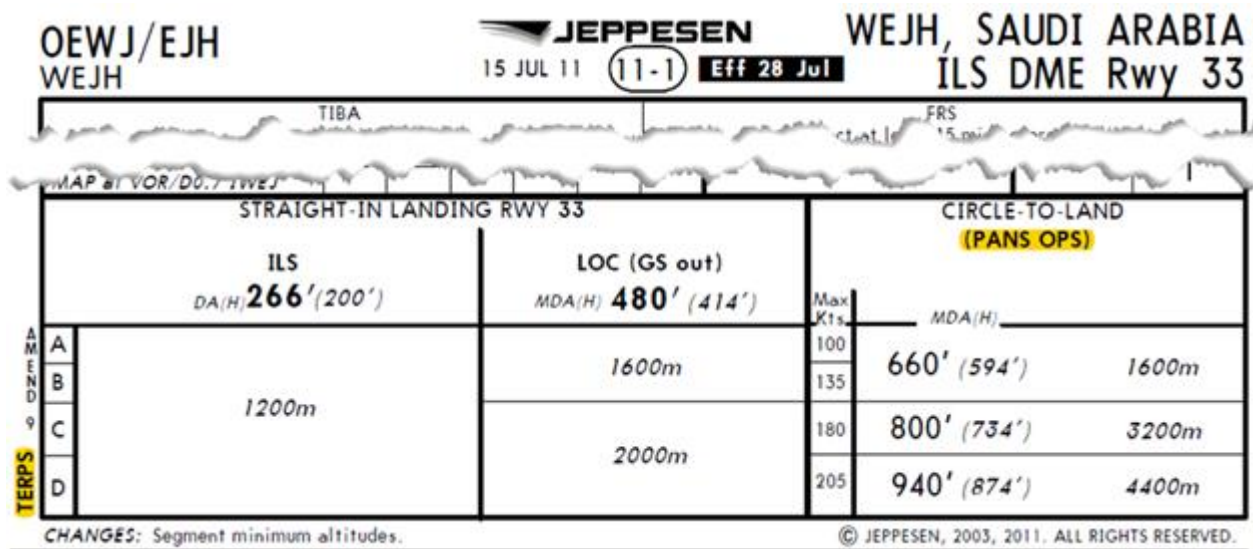
10.3.3. [DoD FLIP] The design criteria used to develop an instrument procedure is published in the bottom left margin below the amendment number and procedure revision date; pilots may infer that US TERPS design criteria is applied when no criteria is published as it is more restrictive. (Figure 10.1).

Figure 10.1. Instrument Procedure Design Criteria – U.S. Government.



10.3.4. [Jeppesen®] The design criteria used to develop an instrument procedure is published in the bottom left margin of the instrument procedure; if multiple design criteria are used to create the instrument procedure; the difference(s) will be annotated on the approach plate. For example, the approach could be designed in accordance with U.S. TERPS criteria, and the circling criteria based on PANS-OPS criteria (Figure 10.2).

Figure 10.2. Instrument Procedure Design Criteria – Jeppesen®.



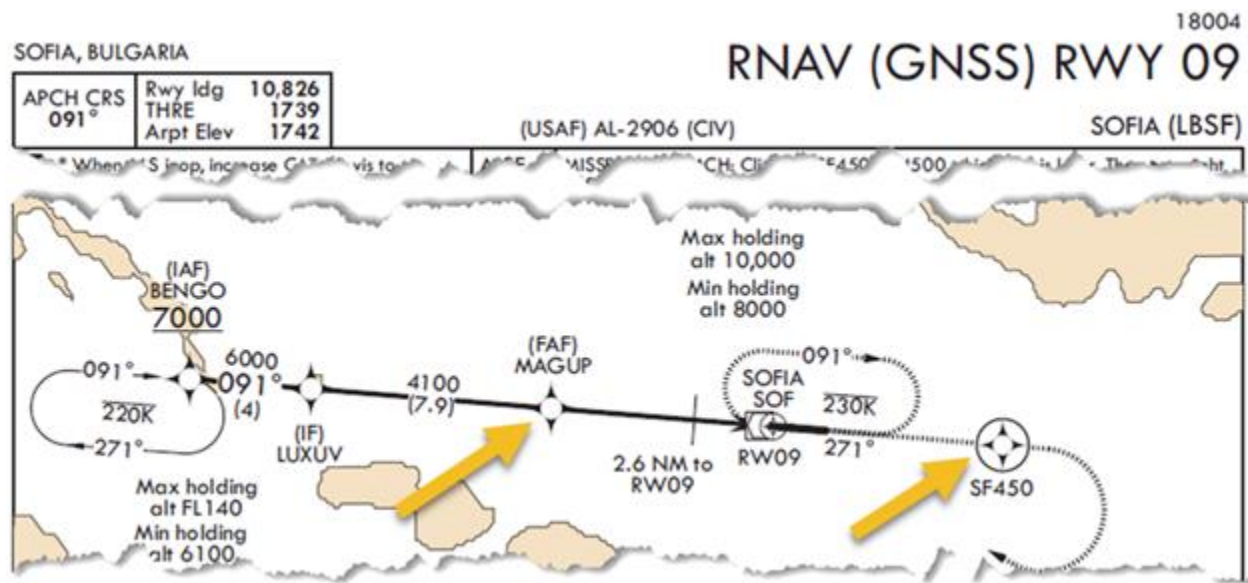
10.4. Waypoints. [FAA-H-8083-16, Chapter 4; ICAO Doc 8168 Volume 1, Part I, Section 4, Chapter 8] Two types of waypoints appear in area navigation procedures: fly-over and fly-by (Figure 10.3). Fly-over waypoints are indicated by the standard waypoint symbol enclosed in a

circle. For a fly-over waypoint, turn anticipation is not allowed. No turn may be accomplished until the aircraft passes over the waypoint. Fly-by waypoints are depicted using the standard waypoint symbol. Turn anticipation is allowed for fly-by waypoints.

10.4.1. A fly-by vertical waypoint is a waypoint for which an aircraft may initiate a vertical rate change and depart the specified vertical path to the active waypoint prior to reaching that waypoint, in order to capture the next vertical path. A fly-over vertical waypoint is a waypoint for which an aircraft remains on the defined vertical path until passing the active waypoint, and may not initiate the necessary vertical rate change to capture the next vertical path until after passing the active waypoint.

10.4.2. Approach waypoints are normally fly-by waypoints; the missed approach waypoint and the missed approach holding waypoint are normally fly-over waypoints. Overlay approach charts and some early stand-alone GPS approach charts may not reflect this convention. The missed approach holding waypoint is normally a fly-over waypoint; however, if it also serves another purpose (e.g., serves as an IAF), it is charted as a fly-by waypoint on the approach plate even though it is a fly-over waypoint for entry into holding.

**Figure 10.3. Fly-by versus Fly-over Waypoint.**



**10.5. Radius-to-Fix (RF).** [ICAO Doc 9613; AC 90-105] RF legs are intended to be applied where accurate, repeatable, and predictable navigation performance is required in a constant radius turn. Use of RF requires MAJCOM approval. (See [Figure 10.4](#) for examples of procedures using RF legs).

10.5.1. This functionality can be used in the following:

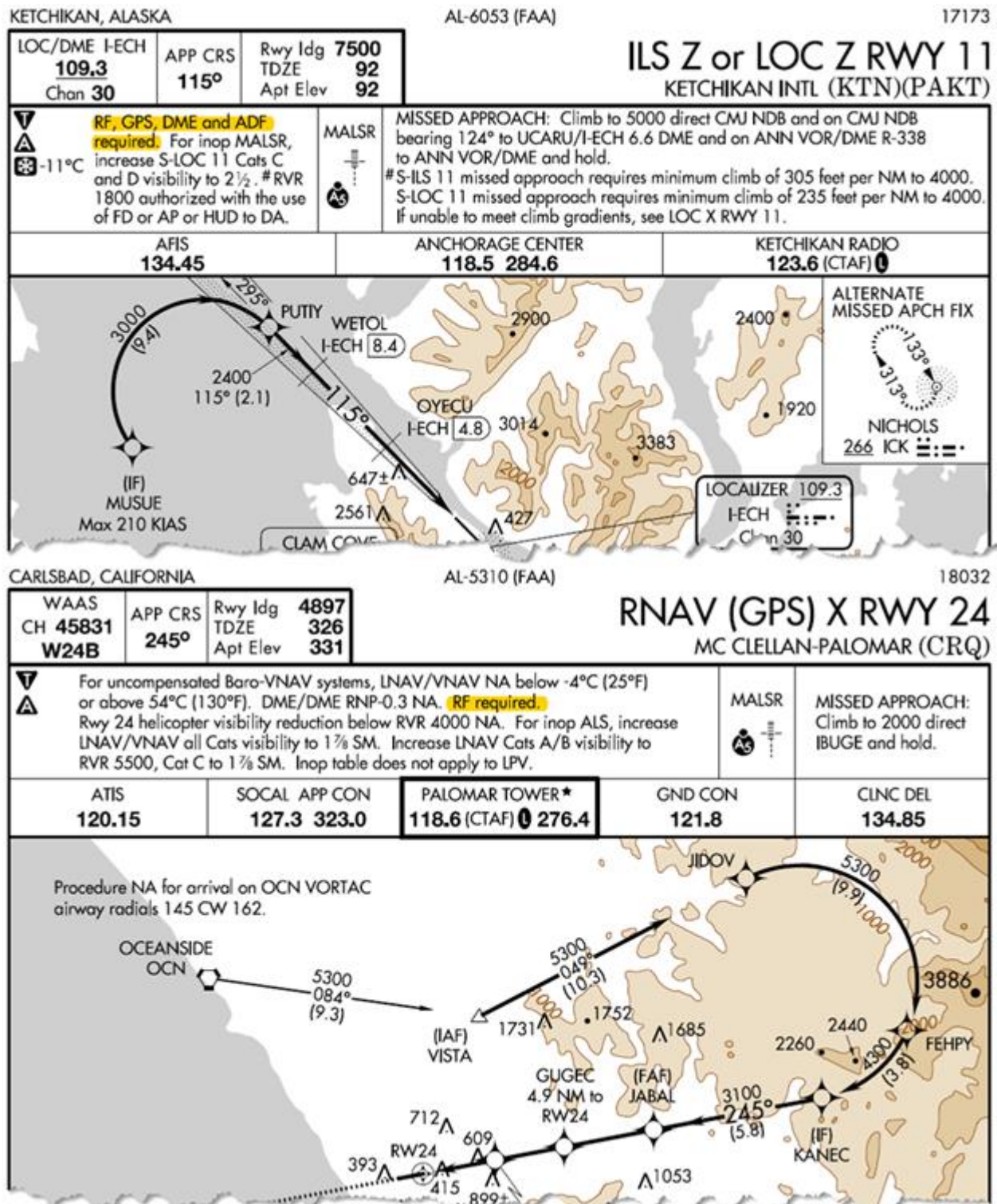
- 10.5.1.1. Initial and intermediate approach segments;
- 10.5.1.2. Final phase of the missed approach;
- 10.5.1.3. Standard Instrument Departures (SID); and
- 10.5.1.4. Standard Terminal Arrival Routes (STAR).

10.5.2. ATC should not issue a “Direct-To” clearance to a waypoint beginning an RF leg or a vector to intercept an RF leg. The aircraft flight manual should document limitations if:

10.5.2.1. The aircraft cannot proceed “Direct-To” the initial fix defining an RF leg segment; or

10.5.2.2. The aircraft cannot accept a radar vector to the middle of an RF leg segment for intercepting and completing the RF leg segment from that point while sustaining the desired level of performance.

Figure 10.4. Radius-to-Fix (RF) Legs.



10.5.3. An autopilot or flight director with at least “roll-steering” capability coupled to the RNP system is required. The autopilot and flight director must operate with suitable accuracy to track the lateral and vertical paths as required by a specific RNP procedure. (T-0).



10.5.3.1. An electronic map display depicting the RNP computed path of the selected procedure is required. **(T-0)**.

10.5.3.2. The flight management computer, the flight director system, and the autopilot must be capable of commanding and achieving a bank angle up to 25 degrees above 400 feet AGL. **(T-0)**.

10.5.4. The flight guidance mode should remain in LNAV when abandoning a procedure while on an RF leg to enable display of deviation and positive course guidance during the RF leg. Crew procedures must be used that assure that the aircraft will respond to the specified flightpath during the RF leg in the event that the aircraft does not provide this capability. **(T-0)**.

10.5.5. When a flight is predicated on flying an RNP procedure with an RF leg, the pilot must determine that the installed autopilot or flight director is operational. **(T-0)**.

10.5.6. The aircraft must be established on the procedure prior to starting the RF leg. **(T-0)**.

10.5.7. The pilot is expected to maintain the centerline of the desired path on RF legs. FTE should be limited to half the navigation accuracy associated with the procedure for normal operations (e.g., 0.5 nautical miles for RNP 1).

10.5.8. The pilot must not exceed maximum airspeeds associated with the RF leg. **(T-0)**.

10.5.9. If an aircraft system failure results in the loss of capability to follow an RF turn, the pilot should maintain the current bank and roll out on the charted RF exit course. The pilot should advise ATC as soon as possible of the system failure.

**10.6. High Performance Military Aircraft (HPMA) Criteria.** [NATO Standard AATCP-1; AFMAN 11-230] HPMA criteria are military unique criteria for instrument procedures that are normally flown by military-type aircraft (i.e., fighter aircraft) serving a specific operational requirement. HPMA criteria introduce a new aircraft category that does not align with existing ICAO aircraft categories. Pilots will not fly HMPA departures or approaches, nor will pilots utilize HPMA lines of minima on an instrument approach without MAJCOM training and approval. **(T-1)**.

**10.7. Chart Reference Number.** [DoD Publication Product Specifications para. 303] The chart legend number at the top of U.S. Government-developed instrument procedures is preceded by the series “AL” (i.e., low instrument procedure) or “JAL” (i.e., high instrument procedure) and dash followed by the chart reference number and the abbreviated name of the appropriate authority who requested the instrument procedure be published, placed inside parentheses. Brackets indicate the procedure is captured digitally (e.g., AL-000 [USA]; JAL-0000 [USAF]; AL-0000 [USN]; AL-000 [FAA]).

10.7.1. The notation at the top of a DoD-published instrument procedure cannot be used to determine what design criteria was used to develop the procedure; departure end crossing restrictions are not consistently published in Terminal Procedure Publications.

10.7.2. On DoD-published foreign instrument procedures, the chart legend number is preceded by the OPR who requested the procedure publication and followed by the ICAO State authority who developed the procedure in parentheses or brackets (**Figure 10.5**). These procedures are developed by the ICAO State’s procedure development authority and are published in DoD FLIP. The ICAO State identifier may be a 2-letter code (e.g., “IZ”); “CIV”

or “MIL” indicates the ICAO State has more than one procedure design authority. DoD-published foreign instrument procedures are verified and validated as safe by a DoD procedure specialist. The DoD procedure specialist assumes responsibility for maintaining the currency and accuracy of the DoD-published procedure until it is removed from the Terminal Procedure Publication.

**Figure 10.5. DoD Published Foreign Instrument Procedure.**

|  |                         |  |                                    |                     |
|--|-------------------------|--|------------------------------------|---------------------|
| BAGHDAD, IRAQ                            |                         |  | 18060                              |                     |
|  |                         |  | ILS or LOC/DME RWY 15L             |                     |
| LOC/DME I-YDB<br><b>110.7</b><br>Chan 44 | APCH CRS<br><b>146°</b> | Rwy ldg <b>13,124</b><br>THRE <b>113</b><br>Arpt Elev <b>114</b> | <b>(USAF)</b> AL-3372 <b>(CIV)</b> | BAGHDAD INTL (ORBI) |

**10.8. Foreign Terminal Instrument Procedure (FTIP).** On 7 June 1996 (last updated 2000), the Secretary of Defense issued the “*DoD Instrument Flight Procedures Policy*” memo. The memo required Services to validate any terminal instrument procedures not developed by the FAA or US military authority. The validation ensures instrument procedures meet an acceptable standard prescribed in U.S. TERPS, International Civil Aviation Organization’s Procedures for Air Navigation Services-Aircraft Operations (ICAO PANS-OPS), or North Atlantic Treaty Organization’s Military Instrument Procedures Standardization (NATO MIPS) design criteria. **Note:** Standard Terminal Arrival procedures (STARs) do not require a review.

10.8.1. AFMAN 11-230 outlines USAF and MAJCOM responsibilities, as well as the acceptance and validation review process, including flyability checks and flight inspections.

10.8.2. Foreign instrument procedures published in DoD FLIP have been validated by DoD procedure specialists.

10.8.3. The DoD maintains a “DoD Accepted Host Nation List” (most up to date list located on the FTIP SharePoint site in [paragraph 10.10.2](#)). The USAF refers to countries on the list as *special accredited* and places a very high degree of confidence in the host nation’s flight inspection, instrument flight procedure development, and instrument flight procedure publication practices.

**10.9. Non-U.S. Government Published Instrument Procedures.** For foreign instrument procedures not published in DoD FLIP and the host nation is:

10.9.1. On the DoD Accepted Host Nation List do not require any further validation nor FTIP review. These host nation programs are considered equal to DoD or FAA programs. **Note:** Aircrew must use procedures fully translated in English in accordance with [paragraph 4.14](#).

10.9.2. Not on the DoD Accepted Host Nation List, require an FTIP review. These host nation programs produce instrument procedures that may require a full validation (which could include flyability validation) before an FTIP review is approved. The DoD requires a flyability check is accomplished before a procedure can be published in DoD FLIP. Aircrew may be asked to accomplish flyability checks as part of the flyability validation; procedures are outlined in AFMAN 11-230. **Note:** Host nation instrument procedures published in English, in accordance with [paragraph 4.14](#), with a current FTIP review are authorized.

10.9.3. Trained aircrews are authorized to use a host nation product if:



10.9.3.1. The procedure is published in DoD FLIP; or

10.9.3.2. The host nation is on the DoD Accepted Host Nation List and the procedure is published in English in accordance with [paragraph 4.14](#); or

10.9.3.3. The procedure has a current FTIP review.

**10.10. FTIP Review Request.** FTIP reviews provide notes, corrections, and types of conditions (e.g., day, night) under which a crew has been approved to fly a specific foreign instrument procedure.

10.10.1. MAJCOM/A3 in the grade of O-8 or above (or the first O-8 in the MAJCOM/A3 chain of command) may waive the FTIP review for short-notice, humanitarian, contingency, medical evacuation, “special” access and urgent State Department missions. This waiver authority will not be further delegated. **(T-1)**.

10.10.2. Aircrew will verify the procedure to be flown has an FTIP review that is current and valid for the entire mission duration **(T-2)**. Current FTIP reviews are available on the USAF FTIP SharePoint site:  
<https://intelshare.intelink.gov/sites/usafterps/layouts/15/start.aspx#/SitePages/Home.aspx>

10.10.2.1. Aircrews will request a review (directly through the USAF FTIP SharePoint site) of the host nation procedure for an expired FTIP review or if no FTIP review is available. **(T-1)**. **Note:** Aircrew should request a comparison evaluation if planning on using a commercially-produced product; a comparison evaluation is not included in an FTIP review unless specifically requested.

10.10.2.2. Aircrew may use any FTIP review that has been finalized and submitted to the SharePoint site by another MAJCOM or U.S. military service.

10.10.2.3. Aircrew will review all comments on the FTIP review during preflight planning. **(T-1)**.

### **10.11. Comparison Evaluation for Commercially-Produced Products.**

10.11.1. MAJCOMs may approve and will provide training to aircrew to fly commercially-produced products. **(T-1)**. At a minimum, this training must include the differences in symbology, weather minimums, NOTAM retrieval, and equipment and airspace requirements. **(T-1)**.

10.11.1. **(AFMC)** Aircrew may use commercially-produced products provided required training is properly documented in the individual’s aircrew training folder.

10.11.2. Comparison evaluations are required for commercially-produced products. **(T-1)**. Comparison evaluations are assessments comparing a host nation produced instrument flight procedure with the corresponding commercially reproduced instrument procedure line-by-line, word-for-word, number-for-number, note-for-note, etc. **Exception:** Jeppesen® products do not require a comparison evaluation but must meet the requirements of [paragraph 10.9.3](#). **Note:** MAJCOM training is required for aircrew to complete a comparison evaluation.

**10.12. NGA Electronic – Instrument Procedure Library (E-IPL).** The E-IPL is not approved for operational use. **(T-1)**. The E-IPL will be a world-wide repository of instrument flight procedures not published in DoD FLIP; it will eventually take the place of the Jeppesen® Military

Chart Service (JMCS). Any messages, emails, or newsletters from NGA or other organizations are not authorization for operational use for these products. HQ USAF will send out a separate message authorizing the operational use of the E-IPL.

## Chapter 11

### WAKE TURBULENCE

**11.1. General.** Every aircraft generates a wake while in flight. A pair of counter-rotating vortices trailing from the wing tips causes wake turbulence and poses problems to other aircraft. This chapter builds on the concepts introduced in FAA handbooks and manuals. Refer to AIM 7-3 for basic wake turbulence information unless otherwise noted.

#### 11.2. Aircraft Weight Classes.

11.2.1. [ICAO] [ICAO Doc 4444, Chapter 4.9] Wake turbulence separation minima is based on a grouping of aircraft types into categories according to the maximum certificated take-off mass as follows:

11.2.1.1. SUPER (J) – A380-800;

11.2.1.2. HEAVY (H) – all aircraft types of 300,000 pounds or more;

11.2.1.3. MEDIUM (M) – aircraft types less than 300,000 pounds but more than 15,500 pounds; and

11.2.1.4. LIGHT (L) – aircraft types of 15,500 pounds or less.

11.2.1.5. Helicopters should be kept well clear of light aircraft when hovering or while air taxiing.

11.2.2. [NAS Only] [FAA Pilot/Controller Glossary] For the purposes of wake turbulence separation minima, ATC classifies aircraft as super, heavy, large, and small as follows:

11.2.2.1. SUPER – The Airbus A-380-800 (A388) and the Antonov An-225 (A225) are classified as super.

11.2.2.2. HEAVY – Aircraft capable of takeoff weights of 300,000 pounds or more whether or not they are operating at this weight during a particular phase of flight.

11.2.2.3. LARGE – Aircraft of more than 41,000 pounds, maximum certificated takeoff weight, up to but not including 300,000 pounds.

11.2.2.4. Small – Aircraft of 41,000 pounds or less maximum certificated takeoff weight.

**11.3. [ICAO] Wake Turbulence Separation.** [ICAO Doc 4444] Distance-based wake turbulence separation minima in [Table 11.1](#) is applied when:

11.3.1. An aircraft is operating directly behind another aircraft at the same altitude or less than 300 meters (1,000 feet) below; or

11.3.2. Both aircraft are using the same runway, or parallel runways separated by less than 760 meters (2,500 feet); or

11.3.3. An aircraft is crossing behind another aircraft, at the same altitude or less than 300 meters (1,000 feet) below.

**Table 11.1. ICAO Distance-based Wake Turbulence Minima.**

| Preceding Aircraft | Succeeding Aircraft | Minimum Distance-based Wake Turbulence |
|--------------------|---------------------|--|
| SUPER              | HEAVY               | 11.1 km/6.0 NM                         |
|                    | MEDIUM              | 13.0 km/7.0 NM                         |
|                    | LIGHT               | 14.8 km/8.0 NM                         |
| HEAVY              | HEAVY               | 7.4 km/4.0 NM                          |
|                    | MEDIUM              | 9.3 km/5.0 NM                          |
|                    | LIGHT               | 11.1 km/6.0 NM                         |
| MEDIUM             | LIGHT               | 9.3 km/5.0 NM                          |

11.3.4. Wake turbulence separation is not required for arriving VFR flights landing on the same runway as a preceding landing HEAVY or MEDIUM aircraft and between arriving IFR flights executing visual approach when the aircraft has reported the preceding aircraft in sight and has been instructed to follow and maintain own separation from that aircraft. ATC should issue a caution of possible wake turbulence. The pilot in command is responsible for wake turbulence spacing. Minimum wake turbulence for landing aircraft is in [Table 11.2](#)

**Table 11.2. ICAO Time-based Wake Turbulence Minima.**

|        | Landing Behind | Minimum Wake Turbulence (minutes) |
|--------|----------------|-----------------------------------|
| MEDIUM | HEAVY          | 2                                 |
| LIGHT  | HEAVY          | 3                                 |
|        | MEDIUM         |                                   |

11.3.5. A minimum separation of 2 minutes is applied between a LIGHT or MEDIUM aircraft taking off behind a HEAVY aircraft or a LIGHT aircraft taking off behind a MEDIUM aircraft when the aircraft are using:

11.3.5.1. The same runway;

11.3.5.2. Parallel runways separated by less than 760 meters (2,500 feet);

11.3.5.3. Crossing runways if the projected flight path of the second aircraft crosses the projected flight path of the first aircraft at the same altitude or less than 300 meters (1,000 feet) below; or

11.3.5.4. Parallel runways separated by 760 meters (2,500 feet) or more if the projected flight path of the second aircraft crosses the projected flight path of the first aircraft at the same altitude or less than 300 meters (1,000 feet) below.

11.3.6. A separation minimum of 3 minutes is applied between a LIGHT or MEDIUM aircraft when taking off behind a HEAVY aircraft or a LIGHT aircraft when taking off behind a MEDIUM aircraft from:

11.3.6.1. An intermediate part of the same runway; or

11.3.6.2. An intermediate part of a parallel runway separated by less than 760 meters (2,500 feet).

11.3.7. A separation minimum of 2 minutes is applied between a LIGHT or MEDIUM aircraft and a HEAVY aircraft and between a LIGHT aircraft and a MEDIUM aircraft when operating on a runway with a displaced landing threshold when:

11.3.7.1. A departing LIGHT or MEDIUM aircraft follows a HEAVY aircraft arrival and a departing LIGHT aircraft follows a MEDIUM aircraft arrival; or

11.3.7.2. An arriving LIGHT or MEDIUM aircraft follows a HEAVY aircraft departure and an arriving LIGHT aircraft follows a MEDIUM aircraft departure if the projected flight paths are expected to cross.

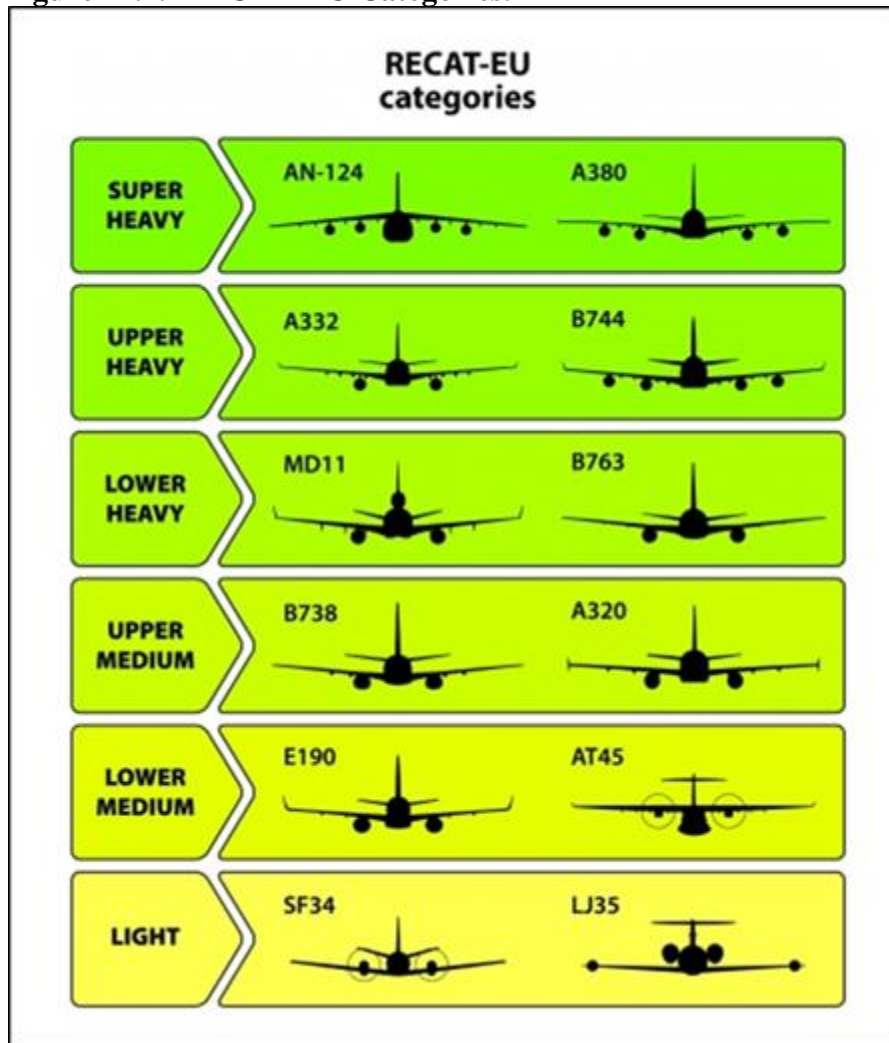
11.3.8. A separation minimum of 2 minutes is applied between a LIGHT or MEDIUM aircraft and a HEAVY aircraft and between a LIGHT aircraft and a MEDIUM aircraft when the heavier aircraft is making a low or missed approach and the lighter aircraft is:

11.3.8.1. Utilizing an opposite-direction runway for take-off; or

11.3.8.2. Landing on the same runway in the opposite direction, or on a parallel opposite-direction runway separated by less than 760 meters (2,500 feet).

**11.4. European Wake Vortex Re-categorization (RECAT-EU).** [Eurocontrol RECAT-EU] RECAT-EU is a new, much more precise categorization of aircraft than the traditional ICAO wake categories ([Figure 11.1](#)). It aims at safely increasing airfield capacity by redefining wake turbulence categories and their associated separation minima. It divides the current HEAVY and MEDIUM categories into two sub-categories and creates a new SUPER HEAVY category which includes the Airbus A380 and AN-124.

Figure 11.1. RECAT-EU Categories.



11.4.1. RECAT-EU distanced-based separation minima on approach and departure is shown in [Table 11.3](#)

Table 11.3. RECAT-EU Distance-based Wake Turbulence Minima.

| Leader/Follower | SUPER HEAVY | UPPER HEAVY | LOWER HEAVY | UPPER MEDIUM | LOWER MEDIUM | LIGHT |
|-----------------|-------------|-------------|-------------|--------------|--------------|-------|
| SUPER HEAVY     | 3           | 4           | 5           | 5            | 6            | 8     |
| UPPER HEAVY     |             | 3           | 4           | 4            | 5            | 7     |
| LOWER HEAVY     |             | (*)         | 3           | 3            | 4            | 6     |
| UPPER MEDIUM    |             | 5           |             |              |              |       |
| LOWER MEDIUM    |             | 4           |             |              |              |       |
| LIGHT           |             | 3           |             |              |              |       |

**Note:** Distance in nautical miles. (\*) means “minimum radar separation,” set at 2.5 nautical miles, is applicable as per ICAO Doc 4444 provisions.

11.4.2. RECAT-EU time-based separation minima on departure is shown in [Table 11.4](#)

**Table 11.4. RECAT-EU Time-based Wake Turbulence Minima.**

| Leader/Follower               | SUPER HEAVY | UPPER HEAVY | LOWER HEAVY | UPPER MEDIUM | LOWER MEDIUM | LIGHT |
|-------------------------------|-------------|-------------|-------------|--------------|--------------|-------|
| SUPER HEAVY                   |             | 100         | 120         | 140          | 160          | 180   |
| UPPER HEAVY                   |             |             |             | 100          | 120          | 140   |
| LOWER HEAVY                   |             |             |             | 80           | 100          | 120   |
| UPPER MEDIUM                  |             |             |             |              |              | 120   |
| LOWER MEDIUM                  |             |             |             |              |              | 100   |
| LIGHT                         |             |             |             |              |              | 80    |
| <b>Note:</b> Time in seconds. |             |             |             |              |              |       |

**11.5. [NAS Only] Wake Turbulence Separation.** [AIM 7-3-9] Controllers are required to apply no less than specified minimum separation to all IFR aircraft, to all VFR aircraft receiving Class B or Class C airspace services when operating behind super or heavy aircraft, and to small aircraft operating behind a C-32 / Boeing 757 (B757).

11.5.1. Separation is applied to aircraft operating directly behind a super or heavy at the same altitude or less than 1,000 feet below, and to small aircraft operating directly behind a B757 at the same altitude or less than 500 feet below:

- 11.5.1.1. Heavy behind super – 6 miles.
- 11.5.1.2. Large behind super – 7 miles.
- 11.5.1.3. Small behind super – 8 miles.
- 11.5.1.4. Heavy behind heavy – 4 miles.
- 11.5.1.5. Small/large behind heavy – 5 miles.
- 11.5.1.6. Small behind B757 – 4 miles.

11.5.2. Separation is provided to small aircraft measured from the time the preceding aircraft is over the landing threshold:

- 11.5.2.1. Small landing behind heavy – 6 miles.
- 11.5.2.2. Small landing behind large, non-B757 – 4 miles.

11.5.3. Appropriate time or distance intervals are provided to departing aircraft when the departure is from the same threshold, a parallel runway separated by less than 2,500 feet with less than 500 feet threshold stagger, or on a crossing runway and projected flight paths cross:

- 11.5.3.1. Three minutes or the appropriate radar separation when takeoff is behind a super aircraft.
- 11.5.3.2. Two minutes or the appropriate radar separation when takeoff is behind a heavy aircraft.
- 11.5.3.3. Two minutes or the appropriate radar separation when a small aircraft takeoff is behind a B757.
- 11.5.3.4. Controllers may not reduce or waive these intervals.



11.5.4. A 3-minute interval is provided when a small aircraft takeoff is:

11.5.4.1. From an intersection on the same runway (same or opposite direction) behind a departing large aircraft or B757,

11.5.4.2. In the opposite direction on the same runway behind a large aircraft or B757 takeoff, low approach, or missed approach; or

11.5.4.3. This 3-minute interval may be waived upon specific pilot request; it may not be waived behind a B757.

11.5.5. A 4-minute interval is provided for all aircraft taking off behind a super aircraft, and a 3-minute interval is provided for all aircraft taking off behind a heavy aircraft when the operations are as described in [paragraph 11.5.4](#) and are conducted on either the same runway or parallel runways separated by less than 2,500 feet. Controllers may not reduce or waive this interval.

11.5.6. Pilots may request additional separation (i.e., 2 minutes instead of 4 or 5 miles) for wake turbulence avoidance. This request should be made as soon as practical on the ground control frequency and at least before taxiing onto the runway. **Note:** The pilot-in-command of an aircraft is directly responsible for and is the final authority as to the operation of that aircraft.

11.5.7. Controllers may anticipate separation and need not withhold a takeoff clearance for an aircraft departing behind a large, heavy, or super aircraft if there is reasonable assurance the required separation exists when the departing aircraft starts takeoff roll.

## Chapter 12

### ENROUTE NAVIGATION

#### 12.1. Airspace and Airspace Classification.

12.1.1. The PIC is the clearance authority for flight in uncontrolled airspace. **(T-0)**.

12.1.2. Controlled Airspace.

12.1.2.1. The PIC is the clearance authority for VFR flight in controlled airspace. Do not cancel IFR until airspace cloud clearances and visibility requirements are met [14 CFR Part 91.155]. **(T-0)**. **Note:** See [Table 12.1](#) or [Table 12.2](#)

12.1.2.2. Pilots shall obtain an ATC clearance before departing under IFR, as soon as practicable after departing under VFR, or before entering controlled airspace [14 CFR Part 91.173]. **(T-0)**.

12.1.3. The PIC will apply the operating rules associated with the more restrictive airspace designation when overlapping airspace designations exist. [14 CFR Part 71.9]. **(T-0)**.

12.1.4. The PIC will not transit airspace without the required minimum equipment unless authorized by ATC. [14 CFR Part 91.126] **(T-0)**.

12.1.5. The PIC will adhere to ADIZ procedures unless approved for a specific mission exception. [14 CFR Part 99] **(T-0)**.

12.1.6. **[NAS Only]** Certain areas are prescribed special air traffic rules (e.g., Luke AFB, Washington, D.C., Grand Canyon) areas and pilots must adhere to 14 CFR Part 93 unless otherwise authorized by ATC [AIM 3-5-7; 14 CFR Part 93; FAA JO 7210.3]. **(T-0)**.

12.1.7. MAJCOMs must provide approval and guidance for operations in the North Atlantic High Level Airspace (NAT HLA). Comply with applicable FLIP area planning documents. **(T-0)**.

12.1.8. The PIC will not operate in RVSM airspace without functional RVSM equipment. **(T-0)**. **Note:** ATC may authorize non-RVSM aircraft to operate in RVSM airspace on a workload permitting basis. Unless specifically cleared by ATC, comply with applicable FLIP area planning documents. **(T-0)**. Notify ATC as soon as possible if required equipment fails after entering RVSM airspace. **(T-0)**. [14 CFR Part 91 Appendix G]

**12.2. Oceanic and Remote Continental Airspace.** [AC 91-70] Procedures for operating in oceanic and remote continental airspace are constantly evolving; pilots should closely monitor for changes in these procedures for any oceanic or remote continental airspace in which they operate. ICAO Doc 10037, *Global Operational Data Link (GOLD) Manual*, provides guidance and information concerning data link operations and is intended to facilitate the uniform application of SARPs contained in numerous ICAO Annexes, ICAO Doc 4444, and ICAO Doc 7030.

12.2.1. North Atlantic Region. NAT Doc 007, North Atlantic Operations and Airspace Manual, is intended to serve as guidance for operation in the North Atlantic Region. It is a single source document that references the regulatory material in numerous ICAO Annexes, ICAO Doc 4444, ICAO Doc 7030, ICAO State AIPs, and current NOTAMS. The FAA's North Atlantic Resource Guide for U.S. Operators is updated quarterly and available via the

FAA website. It discusses emphasis items, contingency procedures, weather deviation requirements, and flight planning procedures.

12.2.2. Pacific Region. The FAA's Pacific Resource Guide for U.S. Operators, is updated quarterly and available via the FAA website. It discusses emphasis items, contingency procedures, weather deviation requirements, and flight planning procedures.

12.2.3. West Atlantic Route System, Gulf of Mexico, and Caribbean Regions. The FAA's WATRS, GoMex, and Caribbean Resource Guide for U.S. Operators, is updated quarterly and available via the FAA website. It discusses emphasis items, contingency procedures, weather deviation requirements, and flight planning procedures.

12.2.4. Extreme Latitude Navigation. Refer to [Chapter 20](#) for navigation in AMU.

### 12.3. Minimum Aircraft Altitude.

12.3.1. When flying under VFR, fly altitudes or flight levels as specified in FLIP [14 CFR Part 91.159, ICAO Annex 2]. **(T-0)**.

12.3.1.1. **[NAS Only]** Fly appropriate VFR hemispheric altitudes when higher than 3,000 feet above the surface, unless authorized by ATC. **(T-0)**. **Exception:** USAF aircraft conducting hurricane reconnaissance flights. [FAA Exemption No. 131]

12.3.1.2. **[NAS Only]** Do not apply these altitudes when turning or holding in a holding pattern of 2 minutes or less. **(T-0)**.

12.3.2. [14 CFR Part 91.177, ICAO Annex 2] When flying under IFR, except when necessary for takeoff, landing, or when being vectored by ATC, do not fly lower than:

12.3.2.1. On Airways, no lower than any published minimum for the airway **(T-0)**.

12.3.2.2. Off Airways, no lower than:

12.3.2.2.1. The Off Route Obstacle Clearance Altitude (OROCA) **(T-1)**;

12.3.2.2.2. The Off Route Terrain Clearance Altitude (ORTCA) **(T-1)**; or,

12.3.2.2.3. An altitude that provides at least 1,000 feet of clearance above all obstacles within 4 NMs of the course to be flown in non-mountainous terrain, or 2,000 feet in mountainous terrain. **(T-0)**.

12.3.3. The PIC will not operate aircraft below an altitude that, should an emergency landing become necessary, creates undue hazard to persons or property. [14 CFR Part 91.119] **(T-0)**. **Exception:** MAJCOM-approved aerial demonstrations or events or during takeoff or landing.

12.3.4. The PIC will adhere to minimum altitudes published in FLIP for all MTRs and special use airspace (e.g., restricted airspace, military operations areas (MOAs), SR, IFR military training routes (IR), VFR military training routes (VR), and controlled firing areas) [14 CFR Part 73.3]. **(T-0)**. **Exception:** Any aircraft operation within a restricted area which is approved by the using agency and coordinated with the controlling ATC agency may deviate from restrictions listed in [paragraphs 12.3.5](#) through [12.3.7](#) if they are not compatible with the operation of the aircraft and create the same hazards as the operations for which the restricted area was designated.

12.3.5. The PIC will operate over non-congested areas at an altitude at or above 500 feet AGL except over open water or in sparsely populated areas. **(T-0)**. Under such exceptions, do not operate aircraft closer than 500 feet to any person, vessel, vehicle, or structure. **(T-0)**. Helicopters in FAA airspace or operating in accordance with host-nation agreements may operate at lower altitudes and in closer proximity if they do not create a hazard to persons or property on the surface. [14 CFR Part 91.119]

12.3.6. The PIC will operate over congested areas (e.g., cities, towns, settlements) or groups of people at an altitude which ensures at least 1,000 feet above the highest obstacle within a 2,000-foot radius. **(T-0)**. Helicopters in FAA airspace or operating in accordance with host-nation agreements may operate at lower altitudes and in closer proximity if they do not create a hazard to persons or property on the surface. [14 CFR Part 91.119]

12.3.7. The PIC will operate no lower than 2,000 feet AGL (mission permitting) over National Park Service monuments, seashores, lake shores, recreation and scenic riverways; US Fish and Wildlife Service refuges; and US Forest Service wilderness and primitive areas (N/A for MTRs, low-altitude tactical navigation areas, and special use airspace). **(T-2)**. Specific areas may require higher altitudes (see FLIP and sectional aeronautical charts).

12.3.8. The PIC will not operate within designated disaster areas unless the aircraft is assisting in disaster relief efforts and is authorized by the official in charge of on scene emergency response activities [14 CFR Part 91.137]. **(T-0)**. NOTAMs concerning disaster relief area temporary flight restrictions will specify the hazard and operating conditions and limitations.

#### **12.4. Aircraft Speed.** [14 CFR Part 91.117, FAA JO 7610.4, ICAO Annex 2]

12.4.1. Conduct supersonic operations in accordance with AFI 13-201, *Airspace Management*.

12.4.2. The PIC will not exceed 250 knots below 10,000 feet MSL. **(T-0)**. Exceeding 250 knots below 10,000 feet MSL is only permitted when in international airspace and the mission requirements dictate, ICAO or host-nation rules permit, or necessary to maintain the minimum safe airspeed as prescribed in the aircraft flight manual. **Note:** If the flight manual airspeed is listed as a range, fly the slowest practical speed. **Exception: (NAS Only)** MAJCOMs may approve operations:

12.4.2. **(AFMC)** Pilots may exceed 250 knots below 10,000 feet MSL when operating in airspace described in [paragraphs 12.4.2.1](#) thru [12.4.2.4](#)

12.4.2.1. Within restricted areas or MOAs.

12.4.2.2. Within DoD and FAA mutually developed instrument routes or DoD developed visual routes. **Note:** The PIC will not exceed 250 knots on SR routes. **(T-1)**.

12.4.2.3. Within unpublished DoD and FAA-designated areas or routes. This provision is intended to accommodate speed requirements, as necessary to accomplish the national defense mission, on an interim basis until the area or route can be published.

12.4.2.4. During large-scale exercises or short-term special missions with appropriate coordination to ensure awareness of the nonparticipating flying public.

12.4.3. [NAS Only] The PIC will not exceed 200 knots at or below 2,500 feet AGL within 4 NM of the primary airport in Class C or Class D airspace unless authorized by ATC or required to maintain the minimum operating airspeed specified in the aircraft T.O. (T-0).

12.4.4. [NAS Only] The PIC will not exceed 200 knots in the airspace underlying Class B airspace or in a VFR corridor designated through Class B airspace unless required to maintain the minimum operating airspeed specified in the aircraft T.O. (T-0).

12.4.5. Holding speeds are in accordance with FLIP or aircraft flight manual guidance. (T-0).

## 12.5. Hazard Avoidance.

12.5.1. The PIC will not operate in any forecast or actual severe condition (e.g., icing, turbulence, bird watch condition). (T-3). **Note:** This includes actual or forecast areas of “moderate to occasional severe” turbulence or “moderate to severe” turbulence. AFH 11-203V1.

12.5.2. The PIC will not intentionally fly into a thunderstorm. (T-1). Do not fly in IMC near thunderstorms without operable weather radar. (T-3).

12.5.2. (AFMC) Thunderstorm avoidance procedures are published in AFMAN 11-2FTV3. Missions requiring planned penetration of a thunderstorm require AFMC/A3 approval. (T-2).

12.5.3. The PIC will not operate within 50 NM of known or reported volcanic ash, unless conducting rescue operations. (T-3). MAJCOMs may issue guidance on operations including procedures for inadvertent ash encounters and avoidance criteria. Aircrew will consult an authorized weather source for current Volcanic Ash Advisory Center ash cloud information (or significant meteorological information (SIGMET)) (T-2). If unable to contact an authorized weather source, consider areas depicted on Volcanic Ash Advisory Center charts (or SIGMETs) as hazardous. Encounters with volcanic ash, the PIC will be reported as soon as possible to the controlling agency and aircraft maintenance authorities. (T-2). Report volcanic ash encounters to pilot-to-metro service or other weather agencies to ensure rapid dissemination.

12.5.4. Bird Watch Condition are in accordance with AFI 91-202, *The US Air Force Mishap Prevention Program* and FLIP.

**12.6. VFR Flight.** Operate VFR in accordance with the weather minimums listed in **Table 12.1** or **Table 12.2** as applicable [14 CFR Part 91.155]. (T-0). **Note:** Aircrew should be able to control the aircraft by referencing visual cues from a discernible horizon while operating VFR.

12.6.1. Before transition from IFR to VFR, establish appropriate visibility and cloud clearances in accordance with **Table 12.1** or **Table 12.2** (T-0). **Note:** Due to the potential for language confusion when flying internationally, pilots must specifically request, “cancelling my IFR flight” and any changes to the current flight plan [ICAO Doc 4444]. (T-1).

12.6.2. During transition from VFR to IFR, maintain appropriate visibility and cloud clearance requirements to a minimum IFR altitude until receipt of the IFR clearance. (T-0).

12.6.3. Do not operate beneath the ceiling under VFR within the lateral boundaries of controlled airspace designated to the surface for an airport when the ceiling is less than 1,000 feet. (T-0).

**Table 12.1. NAS VFR Cloud Clearance and Visibility Minimums.**

| FAA Airspace Class  | Prevailing or Flight Visibility | Distance from Cloud  |
|---|---------------------------------|--|
| Class A   | Not Applicable                  | Not Applicable   |
| Class B   | 3 SM                            | Clear of Clouds  |
| Class C and Class D   | 3 SM                            | 500 feet below, 1,000 feet above, and 2,000 feet horizontal  |
| Class E and G (Fixed-wing)<br>Below 10,000 feet MSL   | 3 SM                            | 500 feet below, 1,000 feet above, and 2,000 feet horizontal  |
| Class E and G (Fixed-wing)<br>At or above 10,000 feet MSL   | 5 SM                            | 1,000 feet below, 1,000 feet above, and 1 SM horizontal  |
| Class E (Helicopter)<br>Below 10,000 feet MSL   | 3 SM                            | 500 feet below, 1,000 feet above, and 2,000 feet horizontal  |
| Class E (Helicopter)<br>At or above 10,000 feet MSL   | 5 SM                            | 1,000 feet below, 1,000 feet above, and 1 SM horizontal  |
| Class G (Helicopter) At<br>or below 1,200 feet<br>AGL (regardless of<br>MSL)  | Day: 1/2 SM<br>Night: 1 SM      | Clear of clouds if operated at a speed that allows the pilot adequate opportunity to see any air traffic or obstructions in time to avoid a collision. |
| Class G (Helicopter)<br>Above 1,200 feet AGL and<br>Below 10,000 feet MSL   | Day: 1 SM<br>Night: 3 SM        | 500 feet below, 1,000 feet above, and 2,000 feet horizontal  |
| Class G (Helicopter)<br>Above 1,200 feet AGL and<br>At or above 10,000 feet   | 5 SM                            | 1,000 feet below, 1,000 feet above, and 1 SM horizontal  |
| <i>Note: When permitted by MAJCOM and ATC, helicopters, in accordance with SVFR, may operate in lower visibility conditions, if maneuvered at a speed that will give adequate opportunity to observe other traffic or any obstacles in time to avoid a collision.</i> |                                 |  |

**Table 12.2. ICAO VFR Cloud Clearance and Visibility Minimums.**

| ICAO Airspace Class | Flight Visibility  | Distance from Cloud |
|---------------------|--|---------------------|
| Class A             | Not Applicable   | Not Applicable      |
| Class B             | 8 KMs above<br>10,000 feet MSL<br>5 KMs below<br>10,000 feet MSL | Clear of clouds     |

|   |  |  |
|---|--|--|
| Class C, D, and E   | Same as Class B  | 1,500 m horizontal<br>300 m (1,000 feet) vertical  |
| Class F and G (Fixed-wing)<br>Above 900 m (3,000 feet)<br>MSL or above 300 m (1,000<br>feet) above terrain, whichever<br>is higher  | Same as Class B  | Same as Class C, D, and E.                         |
| Class F and G (Fixed-wing)<br>At and below 900 m (3,000 feet) or<br>300 m (1,000 feet) above terrain<br>whichever is higher   | 5 KMs  | Same as Class C, D, and E.                         |
| Class F (Helicopter) Above<br>900 m (3,000 feet) or<br>300 m (1,000 feet) above<br>terrain whichever is higher  | 8 KMs above<br>10,000 feet MSL<br>5 KMs below<br>10,000 feet MSL | 1,500 m horizontal<br>300 m (1,000 feet) vertical. |
| Class F and G (Helicopter)<br>At and below 900 m (3,000 feet) or<br>300 m (1,000 feet) above terrain<br>whichever is higher   | 5 KMs<br>(See Note)  | Clear of cloud and in sight of<br>the surface.     |
| Class G (Helicopter)<br>Above 900 m (3,000<br>feet) or<br>300 m (1,000 feet) above<br>terrain whichever is higher   | 8 KMs above<br>10,000 feet MSL<br>5 KMs below<br>10,000 feet MSL | 1,500 m horizontal<br>300 m (1,000 feet) vertical  |
| <i>Note: When permitted by MAJCOM and ATC, helicopters, in accordance with SVFR, may operate in lower visibility conditions, if maneuvered at a speed that will give adequate opportunity to observe other traffic or any obstacles in time to avoid a collision.</i> |  |  |

**12.7. Low-Level and VFR Charts.** The most commonly used charts for VFR operations are the Joint Operations Graphic (JOG), the Tactical Pilotage Chart (TPC), and Sectional Aeronautical Charts. Sectionals may be preferable for VFR planning because they display critical information that may not be printed on other charts (e.g., airspace boundaries, special use airspace, ATC frequencies).

### 12.8. Definitions.

12.8.1. [FAA Pilot/Controller Glossary] Dead reckoning is the navigation of an airplane solely by means of computations based on airspeed, course, heading, wind direction, groundspeed, and elapsed time. Most VFR flights are flown in this manner.

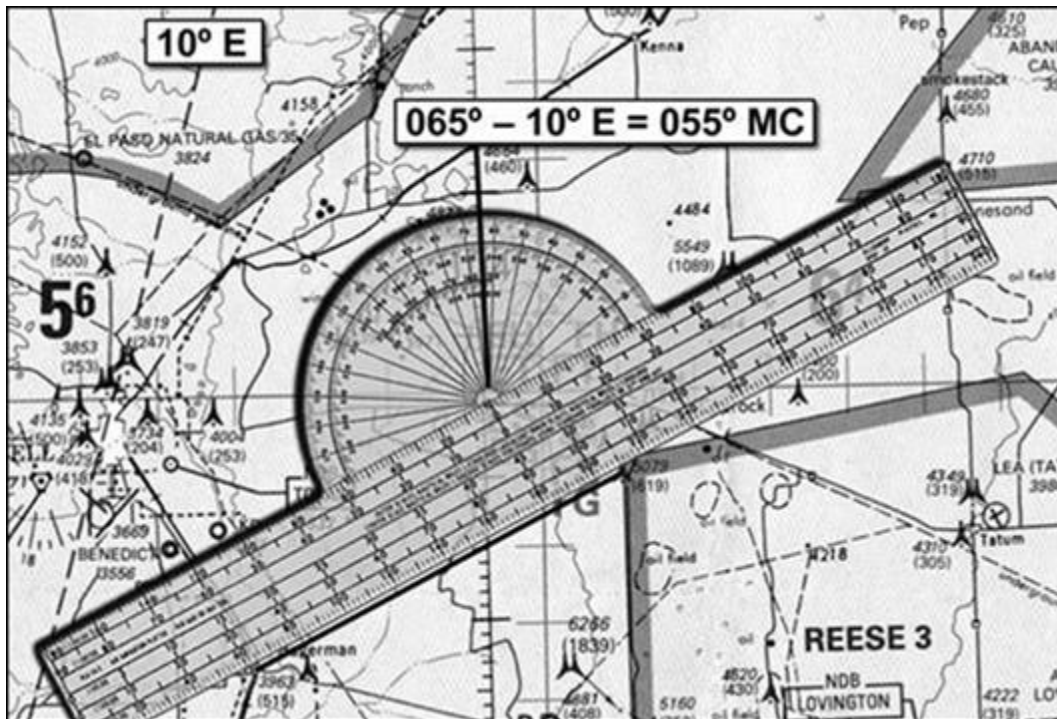
12.8.2. True course is the intended horizontal direction of travel over the surface of the earth, expressed as an angle measured clockwise from true north (000 degrees) through 359 degrees.



12.8.3. Magnetic variation is the difference between true north and magnetic north. The magnetic variation is annotated on navigation charts, is different from one position on the earth to another and varies slightly over time.

12.8.4. Magnetic course is true course corrected for magnetic variation. As shown in [Figure 12.1](#), applying 10 degrees east variation to a true course of 65 degrees results in a magnetic course of 55 degrees. **Note:** East variation is subtracted; west variation is added.

**Figure 12.1. Applying Magnetic Variation.**



12.8.5. A course line is a line between any two points on the route.

12.8.6. A track is the direction the aircraft moves over the ground. An aircraft's track diverges from the desired course line if the pilot does not correct for wind.

12.8.7. True heading is the horizontal direction in which an aircraft is pointed in relation to true north. The difference between track and true heading is caused by wind and is called drift.

12.8.8. Groundspeed is the speed of the aircraft over the ground. Normally expressed in nautical miles per hour (knots). (Accounts for wind effect on aircraft speed across the ground.)

12.8.9. True airspeed is the speed of an aircraft relative to the air surrounding it. True airspeed and groundspeed are rarely the same as the air mass is usually moving relative to the ground.

**12.9. Chart Selection.** Select charts that satisfy navigation requirements and provide the desired detail commensurate with planned altitude and speed. Charts with a scale of 1:250,000 or greater detail are desired for low-level operations. Use a larger scale (i.e., 1:50,000 or greater) to locate the objective. Use a prominent ground feature when changing between charts.

12.9.1. The FAA Aeronautical Information Service Office produces Sectional Charts, VFR Terminal Area Charts (TAC), and VFR Helicopter Charts for use during VFR navigation. The charts have effective and expiration dates; not all charts expire on the same date.

12.9.2. The Jet Navigation Chart (JNC) is a worldwide small-scale aeronautical chart series (1:2,000,000). Used for high-altitude, high-speed, long-range navigation and planning.

12.9.3. The Operational Navigation Chart (ONC) is the standard worldwide small-scale aeronautical chart series (1:1,000,000). It contains cartographic data with an aeronautical overprint depicting obstructions, airfields, special use airspace, NAVAIDs, maximum elevation figures, and related data. The ONC is designed for medium altitude high-speed visual and radar navigation.

12.9.4. The Tactical Pilotage Chart (TPC) is the standard worldwide medium-scale aeronautical chart series (1:500,000). TPCs provide essential cartographic data appropriate to scale, and are overprinted with stable aeronautical information such as obstructions, airfields, special use airspace, NAVAIDs, maximum elevation figures, and related data. Overprint depicts obstructions, airfields, special use airspace, NAVAIDs and related data. A military grid is overprinted for joint interoperability. The TPC is designed for very low-altitude through medium-altitude high speed visual and radar navigation.

12.9.5. The Joint Operations Graphic – Air (JOG-A) is the standard DoD medium scale (1:250,000) chart. The JOG-A is a standard series modified for aeronautical use. The JOG-A displays topographic data such as: relief, drainage, vegetation, populated places, cultural features, coastal hydrography, aeronautical overprint depicting obstructions, airfields, special use airspace, NAVAIDs and related data. The JOG-A supports tactical and other air activities including low altitude visual navigation.

12.9.6. The Topographic Line Map (TLM) is a lithographic map that portrays, in greater detail, topographic and cultural information (1:50,000). Relief is shown by contours and spot elevations measured in meters, feet or yards. The map is a true representation of terrain detail. Features are plotted to correct orientation and true location. The map depicts the level of detail required for detailed route and objective area study as well as foot navigation in the case of a survival or evasion situation.

12.9.7. Flight planning software may be able to generate charts with even smaller scales, digital or satellite-acquired images of ground features, and are useful for selecting specific identifiable features like the western edge of a dam.

**12.10. Chart Hazards.** Aeronautical charts do not depict man-made obstacles less than 200 feet AGL or a change in terrain until it exceeds the chart contour interval. **Exception:** 150ft for JOG. The worst case would be a 199-foot obstacle on terrain with an elevation just below the next higher contour. For a TPC with a contour interval of 500 feet, this results in an uncharted obstacle existing 698 feet above charted terrain.

12.10.1. The Digital Vertical Obstruction File (DVOF) lists known vertical obstructions worldwide for current navigation charts but does not contain man-made obstacles less than 200 feet. **Note:** Vertical obstruction information is obtained from the most reliable sources available, however, is no assurance that all required obstructions are in the file or that their locations and heights are correct.

12.10.2. Obstruction change file (OCF) data is used for updating charts. It is produced every 28 day Aeronautical Information Regulation and Control (AIRAC) cycle and contains only changes to obstacles that meet chart specifications. OCF can be found on the Web DVOF site, <https://dvof.geointel.nga.mil/index.cfm> under "Predefined Queries". You will also find an OCF Users Guide in the same location. Vector Vertical Obstruction Data (VVOD) continues to be produced as well, and contains all obstacles in our database.

12.10.3. Some charts, such as JOG and TLM in some areas of the world, may depict terrain and obstacle heights in meters instead of feet.

12.10.4. If an uncharted obstacle (e.g., tower, power line) is encountered while flying a route, notify the following list of contacts to ensure future chart editions include the obstacle.

12.10.4.1. For Sectionals, contact the FAA at (800) 638-8972 or email them at 9-AMC-[Aerochart@faa.gov](mailto:Aerochart@faa.gov).

12.10.4.2. For NGA products, call the NGA Aero help desk at 877-817-9134 or email [AeroHelp@nga.mil](mailto:AeroHelp@nga.mil). For critical issues that must be resolved immediately, contact the NGA Operations Center at 877-345-1192.

**12.11. Chart Building Requirements.** MAJCOMs will publish guidance on required chart information.

**12.11. (AFMC) Chart Building Requirements.** Reference AFMAN 11-2FTV3.

12.11.1. All charts will be updated with current Digital Aeronautical Flight Information File (DAFIF)/DVOF and the date of the information will be annotated clearly on the charts. **(T-3)**. Charts will be updated with the DVOF at least once a month. **(T-3)**.

12.11.2. All charts used for low altitude navigation should be full color. If making color copies, ensure that all colors come through, as some shades of blue and green may not transfer, causing some terrain features or obstacles to be deleted. **Exception:** Squadron commanders may approve the use of black and white copies of original mission planning charts to enhance navigation capabilities on night vision missions; all mission planning and chart annotations must be done on original full color charts prior to making copies.

12.11.3. Electronic charts may be used in lieu of paper charts, as authorized by MAJCOM.

12.11.3. **(AFMC)** Electronic charts are authorized.

12.11.4. VFR charts will include at a minimum: course lines, magnetic heading, leg distance, and time for segments flown below 1,000 feet AGL. **(T-3)**.

12.11.4.1. Helicopters may fly in an annually surveyed low-level area with current DVOF above 300 feet AGL without the above chart requirements.

12.11.4.2. Helicopters will comply with chart requirements below 300 feet AGL on non-published routes. **(T-3)**.

12.11.5. Normally, "radius of turn" procedures are used (route is drawn considering the distance an aircraft covers while it is turning after passing over a turn point) when drawing the chart, but depending on tactics, airspeed and altitude, other options like point to point may be applicable.

12.11.6. Time elapsed marks and distance remaining marks along the course line of each leg aid in dead reckoning.

**12.12. Route Development.** Select turn points based on a balance between their ease of identification and the tactical situation. Label each turn point with the same identifier used in the flight plan. When a landmark cannot be seen or is not available at a turn point, make the turn at the ETA. Extend the dead reckoning position to the next landmark and fix the position of the aircraft to make sure the desired course and groundspeed are maintained. The desired magnetic course on any given leg corrected for drift is the magnetic heading which parallels the course line. This minimizes departure from the intended track.

12.12.1. Course lines are normally straight segments between points but may be “spaghetti” routing to take advantage of terrain masking. Different tactical situations dictate different transitions from one course to another at turn points.

12.12.2. Checkpoints are landmarks or geographic coordinates on a VFR route used to determine the fix position of the aircraft. Checkpoints should have several related details around and stand out from the background to ensure positive identification. For example, if the checkpoint is a small town, there may be a lake to the north, a road intersection to the south, and a bridge to the east. **Note:** In open areas, any town or road intersection can be used; however, these same features in densely populated areas are difficult to distinguish.

12.12.3. When possible, find a feature on the chart that leads to the turn point. A “funneling feature” forms a visual boundary for, aids in navigating to, and helps in identifying the turn point (e.g., a stream, road, power line, railroad, terrain feature).

12.12.4. Time, distance, and fuel may be annotated in various ways on the chart and may show information for the leg being flown or for the remainder of the route. Ensure that information does not cover up important map features.

12.12.5. The objective area may be a target designated for attack, drop zone, landing zone, photo reconnaissance target, etc.

12.12.6. All charts must have VFR minimum safe altitudes (MSA) and at least one emergency route abort altitude (ERAA). **(T-3).**

12.12.6.1. A VFR MSA is an initial altitude that provides increased clearance from terrain or obstacles when dealing with minor circumstances that do not require an overall route abort. In the absence of more restrictive MAJCOM guidance, compute a VFR MSA for each leg of the route by adding 500 feet to the highest obstruction to flight within 5 nautical miles of route centerline to include the aircraft turn radius. **(T-3).**

12.12.6.2. The ERAA is designed to provide positive IMC terrain clearance during emergency situations that require leaving the low-level structure. Planners may compute several ERAAs for route segments transiting significant terrain differentials, or a single ERAA for the entire low-level route. Pilots will compute an ERAA by adding 1,000 feet (2,000 feet in mountainous terrain) to the elevation of the highest obstruction to flight within 22 nautical miles either side of the entire planned route. **(T-3).** Pilots will compute ERAAs for the route and conspicuously annotate them on the chart. **(T-3).**

12.12.7. Each route should include clearly highlighted emergency divert airfields that may be used if an immediate landing situation occurs on the route.

12.12.8. To enhance scanning while flying the route, pilots will annotate areas where other routes cross the planned route. (T-3).

**12.13. Route Navigation.** Various techniques are used to control arrival time over the objective area. These techniques can be as simple as changing airspeed or more complicated applications of off-route maneuvering. Use caution when departing the planned route of flight, especially at night, to avoid encountering obstacles or flying into known areas of enemy activity when employing off-route time control techniques. If the off-course maneuvering exits the MSA corridor, a new MSA must be computed. This can be done quickly by adding 500 feet to the charted maximum sector elevation(s) in the off-course maneuvering area.

12.13.1. A landmark often falls right or left of course and the pilot should estimate the distance to it. While the ability to estimate distance from a landmark rests largely in skill and experience, the following methods may be of assistance:

12.13.1.1. Compare the distance to a landmark with the distance between two other points as measured on the chart.

12.13.1.2. Estimate the angle between the aircraft and the reference point on the ground. The distance in nautical miles from the landmark to the aircraft's position over the ground depends on the sighting angle:

12.13.1.2.1. [60 degrees]: horizontal distance = (AGL altitude) x 1.7

12.13.1.2.2. [45 degrees]: horizontal distance = AGL altitude.

12.13.1.2.3. [30 degrees]: horizontal distance = (AGL altitude) x 0.6

12.13.2. Aircraft operating in the low altitude environment may elect to enhance their threat avoidance capabilities by hiding their physical, radar, and heat signatures in the available terrain features. Along the low-level route there may be vegetation or changes in elevation that can hide an aircraft from the enemy. Pilots should attempt to include terrain masking in their pre-flight route study so that off-course maneuvering does not negatively impact time on target control. In some cases however, opportunities to terrain mask are not evident until flying the route. Aggressive clearing and chart reading are essential to ensure that the benefits of terrain masking are not negated by unnecessarily increasing the overall risk factor of the mission.

12.13.3. In low-level flight, pilots should be particularly alert for obstructions. Hills and mountains are easily avoided if the visibility is good but radio and television towers, which may extend as much as 2,000 feet or more into the air, often from elevated ground, are less conspicuous. Even more dangerous, the guy-wires supporting such towers are virtually invisible. For this reason, pilots should plan to avoid all towers by a horizontal distance equal to at least the AGL height of the tower. If flying at extremely low altitudes, power lines should be crossed at poles or towers as the line a pilot sees may not be the highest one.

12.13.4. Seasonal changes can conceal landmarks or change their appearance. Small lakes and rivers may dry up during the summer. Their outlines may change considerably during the wet season. In many areas, the only indication that a river exists may be the presence of deciduous trees. Snow can cover up almost all the normally used landmarks. When flying in the winter, it is often necessary to rely on more prominent checkpoints, such as river bends, hills, or larger towns. However, due to the size of these checkpoints, course control can be somewhat degraded.

12.13.5. Many times during low-level flight, the only way to read the wind is from indicators on the surface. On water, if downwind, the leeward side of the waves appears choppy (e.g., wind speeds more than 20 knots cause whitecaps on the surface of lakes). If upwind, the windward side of the waves have a smoother appearance. In a similar fashion, the leaves on deciduous trees are lighter on the underside which show to windward. The shiny and normally darker side of the leaves are present on the leeward side of the tree. Smoke and blowing dust also provide an easy indicator of wind direction.

**12.14. Chart Reading.** Orient the chart so that the course line on the chart is aligned with the intended course of the aircraft and landmarks on the ground appear in the same relative position as the features on the chart.

12.14.1. To navigate accurately, check the expected time on the route segment, select a feature on the chart, and then find it on the ground rather than working from the ground to the chart.

12.14.2. Night navigation comes with certain inherent challenges including hazards due to visual illusions. Lighted reference points tend to look closer than they are at night. Large objects in the background can mask closer obstacles. Darkness adversely affects visual acuity, requiring greater use of peripheral vision. Colored lighting used for chart reading can mask features on the chart. It is critical to understand that contrast can change the way landmarks look at night. Proper use of cockpit lighting and night vision devices enhances night navigation. Use special caution when operating around ridgelines utilizing high moon illumination. Shadowing can make other ridgelines and obstructions extremely difficult to see.

12.14.3. Contours are lines that connect points of equal elevation and are the most common method of showing relief features on a chart. Contour lines are closer together where the slope is steep and farther apart where the slope is gentle. Within the limits of the contour intervals, the height of points and the angle of slope can also be determined from the chart. Contour intervals are determined by the scale of the chart, the amount of relief, and the accuracy of the survey. Contours may be annotated in feet or meters in the chart legend and are frequently labeled with figures of elevation.

12.14.4. A maximum elevation figure is required over all land masses, including areas of unreliable relief, and open water areas containing man-made obstructions (e.g., oil rigs). The maximum elevation figure represents the highest possible elevation of both terrain and vertical obstructions (e.g., towers, trees) in an area bounded by ticked lines. The maximum elevation figure is displayed in feet with large thousands digits and smaller hundreds digits.

12.14.4.1. In areas of unreliable relief, or over water where no known obstructions exceed 200 feet, a note spaced across the area is used ([Figure 12.2](#))

12.14.4.2. The maximum elevation figure is useful if maneuvering off course. If the position of the aircraft is known, the maximum elevation figure for the grid square the aircraft is in (or going to if transiting grid squares to a higher maximum elevation figure) can be used to calculate a new MSA or ERAA by adding an appropriate amount to the maximum elevation figure.

**Figure 12.2. Maximum Elevation Note – Unreliable Relief.**

**MAXIMUM ELEVATION FIGURES ARE  
BELIEVED NOT TO EXCEED 7600 FEET**

**12.15. On-Board Navigation Systems.** Although not required for VFR flight in most types of airspace, it is highly recommended that pilots use their on-board navigation systems during flight under VFR when operational requirements allow. This maximizes situational awareness and enhances safety by facilitating the transition to IFR should it become necessary.

**12.16. Low-Level Time-to-Impact.** At low altitudes, loss of situational awareness can lead to an insidious descent rate; even a minor nose-low attitude can result in terrain impact in a very short time (**Table 12.3** and **Table 12.4**) With wings level, the time differences based on pitch, altitude, and airspeed are all linear (e.g., cutting the altitude in half or doubling the nose-low pitch angle cuts the time-to-impact in half). Historical data shows that while 90% of low-level operations are straight and level, only 9% of low-level accidents occur during straight and level flight. Conversely, turning and looking accounts for only 5% of low-level flight but 52% of accidents. Clearing for terrain must be a priority while maneuvering at low altitudes.

**Table 12.3. Time-to-Impact (seconds) – Wings Level.**

| <b>Flight Path Angle = -1 Degree</b>  |                  |                  |                  |                  |
|---------------------------------------|------------------|------------------|------------------|------------------|
| <b>Altitude</b>                       | <b>480 Knots</b> | <b>360 Knots</b> | <b>240 Knots</b> | <b>120 Knots</b> |
| <b>100' AGL</b>                       | 7                | 10.5             | 14               | 28               |
| <b>300' AGL</b>                       | 21               | 32               | 42               | 84               |
| <b>500' AGL</b>                       | 35               | 53               | 70               | 140              |
| <b>Flight Path Angle = -2 Degrees</b> |                  |                  |                  |                  |
| <b>Altitude</b>                       | <b>480 Knots</b> | <b>360 Knots</b> | <b>240 Knots</b> | <b>120 Knots</b> |
| <b>100' AGL</b>                       | 3.5              | 5                | 7                | 14               |
| <b>300' AGL</b>                       | 10.5             | 16               | 21               | 42               |
| <b>500' AGL</b>                       | 18               | 25               | 35               | 70               |

12.16.1. Most low-level accidents occur while the aircraft is in a bank. Even the smallest distraction or inattention to the proximity of terrain while maneuvering the aircraft can result in a loss of situational awareness and a fatal accident. More back pressure is needed to maintain level flight as bank angle increases. The amount of back pressure required to maintain altitude increases dramatically at bank angles greater than 60 degrees; the descent generated by overbanking without holding the required back pressure is significant. At low altitudes this means a very short time-to-impact shows just how little time there is from 500 feet if a pilot holds the back pressure for one bank angle but flies in an overbanked condition. Considering that many aircraft fly low-levels at 300 feet AGL and normally use a 60 degrees bank angle to turn from one course to another (or even higher bank angles during simulated threat avoidance), a 20 degrees overbank error could result in less than 3 seconds time-to-impact.

12.16.2. Helicopters have additional flight characteristics to consider in banked flight. Refer to MDS-specific flight manuals for cautions and warnings specific to banked flight at low altitudes.



**Table 12.4. Time-to-Impact (seconds) – Banked.**

|                     |            | Intended Degrees of Bank |            |            | Time-to-Impact from 500 feet AGL |
|---------------------|------------|--------------------------|------------|------------|----------------------------------|
|                     |            | 30 degrees               | 45 degrees | 60 degrees |                                  |
| Degrees of Overbank | 10 degrees | 16.2                     | 12.7       | 9.9        |                                  |
|                     | 15 degrees | 12.9                     | 10.3       | 8.0        |                                  |
|                     | 20 degrees | 10.9                     | 8.8        | 6.9        |                                  |

12.16.3. If flying VFR using dead reckoning and aircraft position is unknown, continue to navigate clock to map to ground and turn on time. A slight off-course condition can be quickly corrected once on a new leg of the course with more prominent ground references. While doing this, climb to a higher altitude (weather permitting), being careful to maintain airspeed to preserve dead reckoning accuracy. This conserves fuel while improving NAVAID and radio reception. Attempt to tune and identify NAVAIDs that can provide positional information and do not delay declaring the condition to ATC.

**12.17. Route Abort.** Various situations may make abandoning the route necessary (e.g., low fuel, aircraft emergency, bad weather). In most emergency situations, climbing to the ERAA is the best course of action. Flying at the ERAA ensures that the aircraft is clear of obstructions and minimizes hazards to flight while abort procedures are applied. Aborting the route itself does not normally constitute an emergency; consider all factors when deciding how to proceed after the abort.

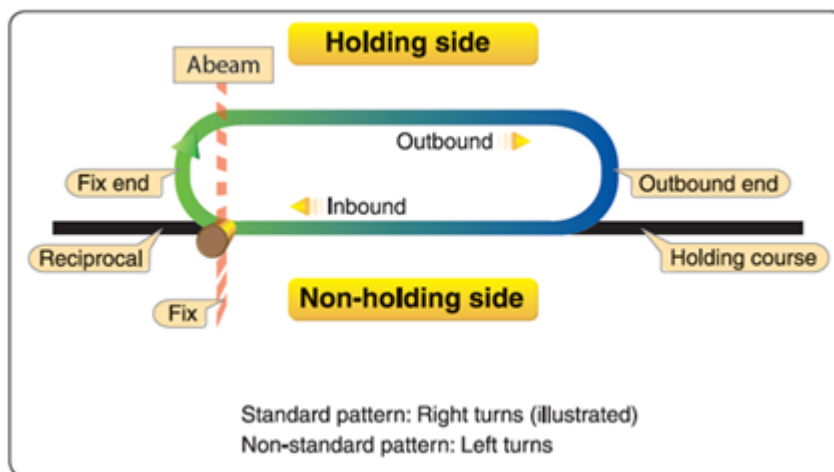
## Chapter 13

### HOLDING

**13.1. General.** Holding is a procedure that delays an aircraft's approach to an airfield or delays an aircraft enroute using a navigation fix. The purpose is to keep an aircraft within a specified airspace while providing IFR separation from other controlled traffic. The clearance to hold may be initiated by the controlling agency or may be requested by the pilot. Reference AIM 5-3-8, FAA-H-8083-16 Chapters 2 and 3, and ICAO Doc 8168 Volume 1 Section 6 for more detailed explanations of holding procedures.

**13.2. Holding Patterns.** The standard holding pattern is a racetrack design consisting of two 180-degree right turns and two straight legs (**Figure 13.1**). The holding pattern is non-standard when turns are made to the left.

**Figure 13.1. Standard Holding Pattern.**



13.2.1. Holding patterns have inbound course guidance provided by a VOR, TACAN, NDB, localizer, or area navigation systems. If NAVAIDs are co-located to define the holding pattern, it is the pilot's option as to which NAVAID to use.

13.2.2. U.S. TERPS design criteria states that the use of TACAN station passage as a fix is not acceptable for holding fixes (regardless of altitude) or high altitude IAFs (those IAFs which are at or above FL180). This restriction is driven by the TACAN fix error involved in station passage. Therefore, if the aircraft is TACAN-only equipped, do not hold directly over a TACAN or collocated VOR/TACAN (VORTAC) facility or plan to use these facilities as high altitude IAFs. TACAN station passage can be used to identify an IAF below FL180 regardless of whether the approach is published as a low or high approach.

**13.3. Holding Instructions.** ATC should issue complete holding instructions (unless the pattern is charted), an "expect further clearance" time, and best estimate of any additional delay when an aircraft is cleared to a fix other than the destination airfield and delay is expected. The pilot is expected to hold as depicted on the appropriate chart (i.e., on the assigned procedure or route) if the holding pattern is charted and the controller doesn't issue complete holding instructions (**Figure 13.2**). ATC may omit all holding instructions except the charted holding direction and the

statement “as published” when the pattern is charted on the assigned procedure or route being flown (e.g., “Hold north as published”). Query the controller if there is any doubt about the clearance. **Note:** ATC must always issue complete holding instructions when pilots request them.

**Figure 13.2. Multiple Holding Patterns at Same Fix.**

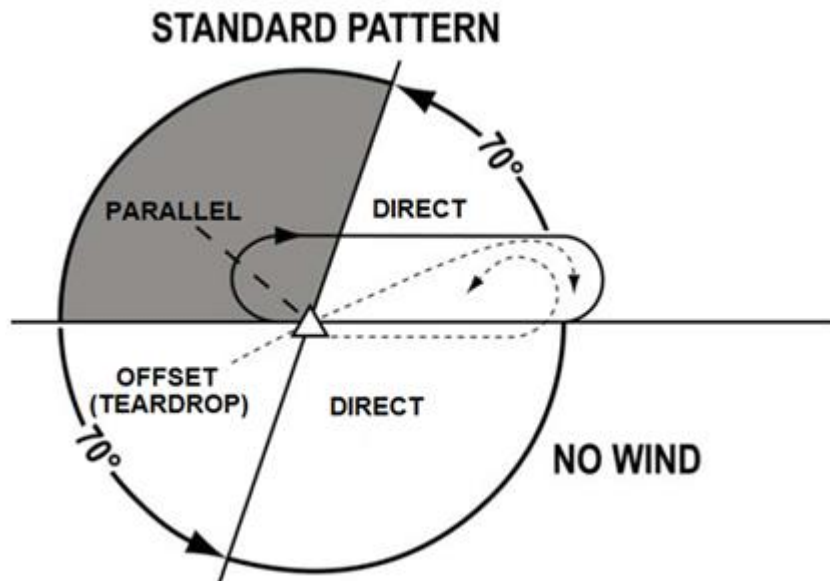


**13.4. Holding Entry.** Holding protected airspace is designed based in part on pilot compliance with the three holding pattern entry sectors: parallel, direct, and offset. In the NAS, the offset entry sector is referred to as the teardrop entry sector ([Figure 13.3](#)).

13.4.1. Holding entry procedures are mandatory outside the NAS. **(T-0).**

13.4.2. **[NAS Only]** Holding entry techniques using the sector method are recommended.

**Figure 13.3. Holding Entry Sectors.**



**13.5. Holding Bank Angle.** Make all turns during entry and while holding at:

13.5.1. 3 degrees per second or 25 degrees bank angle, whichever requires a lesser bank angle.

13.5.2. [NAS Only] 3 degrees per second, 30 degrees bank angle, or 25 degrees bank angle when using a flight director system.

**13.6. Maximum Holding Airspeed.** Advise ATC immediately if unable to maintain below the maximum holding airspeed (e.g., turbulence, icing, aircraft performance) or if unable to accomplish any part of the holding procedure. When such higher speeds are no longer necessary, operate according to the appropriate published holding speed and notify ATC.

13.6.1. Maximum holding airspeeds are in accordance with **Table 13.1** unless depicted otherwise. Many ICAO States publish their own holding airspeeds. This information should be published in the ICAO State AIP and FLIP AP series. Some holding pattern airspeeds are published on instrument procedures. Maximum holding airspeeds are designed to prevent the aircraft from exceeding protected airspace and have no relation to the holding speed specified in the aircraft flight manual.

13.6.2. Holding patterns may be restricted to a maximum speed. The speed restriction is depicted inside the holding pattern on the chart (**Figure 13.4**). The aircraft should be at or below the maximum airspeed prior to initially crossing the holding fix.

13.6.3. [NAS Only] A maximum airspeed of 310 knots is permitted in climb-in-holding, unless a maximum holding airspeed is published, in which case that maximum airspeed is applicable. The airspeed limitations in 14 CFR Part 91.117 still apply. Refer to **Chapter 15** for more information.

**Table 13.1. Maximum Holding Airspeeds.**

| NAS<br>(1)   | Altitude / Level<br>(MSL)<br>(2) | ICAO<br>Normal                   | ICAO<br>Turbulence<br>(3)             | ICAO<br>Helicopter<br>(4) |
|--|----------------------------------|----------------------------------|---------------------------------------|---------------------------|
| 265  | 34,000+                          | 0.83 Mach                        |                                       | 170                       |
|  | 34,000                           | 265                              | 280 or 0.8 Mach,<br>whichever is less |                           |
|  | 20,000                           | 240                              | 280 or 0.8 Mach,<br>whichever is less |                           |
| 230  | 14,000                           | 170 (CAT A/B)<br>230 (CAT C/D/E) | 170 (CAT A/B)                         | 100                       |
| 200  | 6,000                            |                                  | 280 (CAT C/D/E)                       |                           |
|  |                                  | MHA                              |                                       |                           |
| <b>Notes:</b>  |                                  |                                  |                                       |                           |
| 1) NAS Exceptions:   |                                  |                                  |                                       |                           |
| a) USAF Fields: 310  |                                  |                                  |                                       |                           |
| b) Navy Fields: 230  |                                  |                                  |                                       |                           |
| c) COPTER IAP 90   |                                  |                                  |                                       |                           |
| 2) The levels shown represent altitudes or corresponding FLs depending upon the altimeter setting in use.  |                                  |                                  |                                       |                           |
| 3) Pilots must obtain ATC approval to hold at the speeds reserved for turbulence conditions unless the relevant publications indicate that the holding area can accommodate aircraft flying at these high holding speeds. (T-0). |                                  |                                  |                                       |                           |
| 4) The maximum holding speed for helicopters is 100 knots up to 6,000 feet inclusive and 170 knots above 6000 feet.  |                                  |                                  |                                       |                           |

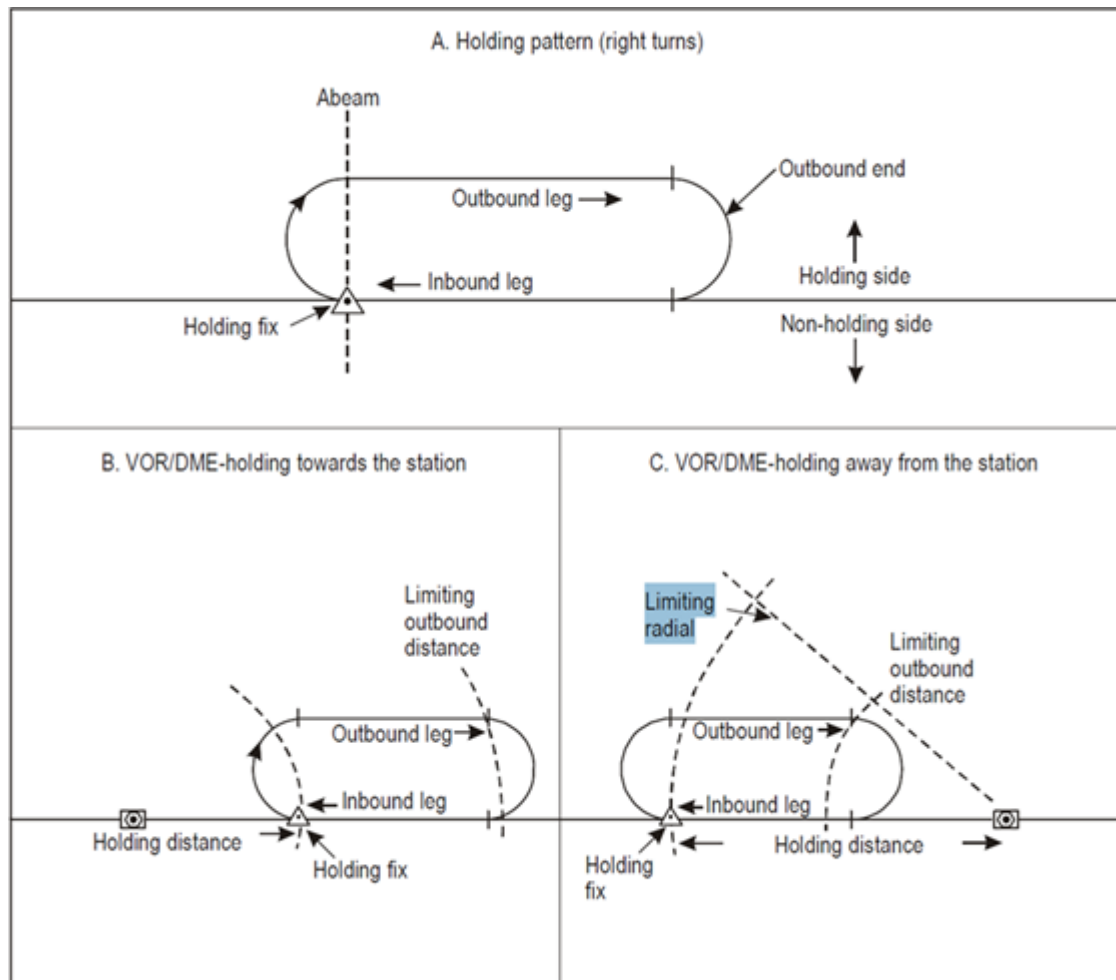
**Figure 13.4. Maximum Holding Airspeed.**

**13.7. Holding Length.** Holding timing is 1 minute at or below 14,000 feet MSL and 1.5 minutes above 14,000 feet MSL, unless otherwise directed by ATC.

13.7.1. Timing is based on the outbound leg. Outbound timing begins over or abeam the fix, whichever occurs later. If the abeam position cannot be determined, start timing when the turn to the outbound heading is completed.

13.7.2. [NAS Only] Timing is based on the inbound leg. The initial outbound leg should be flown for 1 minute or 1.5 minutes (as appropriate). Timing for subsequent outbound legs should be adjusted, as necessary, to achieve proper inbound leg time.

13.7.3. A limiting radial may be published ([Figure 13.5](#)). In cases of holding where the distance from the holding fix to the VOR/DME station is short, a limiting radial may be specified (e.g., airspace conservation is essential). If the limiting radial is reached before the limiting outbound distance, the radial should be followed until a turn inbound is initiated at the limiting outbound distance.

**Figure 13.5. ICAO Limiting Radial.**

**13.8. Drift Corrections.** After entering the holding pattern, the pilot is expected to compensate for known winds to arrive at an outbound position from which a turn places the aircraft on the inbound holding course. Compensate for wind effect primarily by drift correction on the inbound and outbound legs. When outbound, triple the inbound calculated drift correction (e.g., if correcting left by 8 degrees on the inbound leg, correct right by 24 degrees when on the outbound leg). Triple drift is the only method that allows for a constant angle of bank through inbound and outbound turns. Refer to [Attachment 2](#) for drift calculations.

**13.9. Fuel Consideration.** Once established in the holding pattern, a fuel calculation should be carried out. Determine how long it is possible to remain in the holding pattern and maintain fuel awareness throughout the holding maneuver.

**13.10. Use of Area Navigation Guidance and Holding.** RNAV systems, including multi-sensor FMS and stand-alone GNSS receivers may be used to provide lateral guidance when holding. The way holding is implemented in an RNAV system varies between aircraft and RNAV system manufacturers.

## Chapter 14

### ARRIVAL

**14.1. General.** Preparation for the arrival and approach begins long before the descent from the enroute phase of flight. The enroute descent is a transition from the enroute structure to the airfield environment. Optimum IFR arrival options include flying directly from the enroute structure to an approach gate or IAF, a visual arrival, STAR, or radar vectors.

**14.2. Weather.** Do not begin a descent or commence an approach when the reported weather at the destination airfield is below the lowest compatible approach minimums. **(T-1).**

14.2.1. Use the prevailing visibility or RVR for straight in or sidestep approaches. **(T-1). Note:** The appropriate prevailing visibility or RVR immediately follows the published DA, decision height (DH), or MDA. The numbers in parentheses are for required ceiling and visibility purposes (i.e., calculating required minimums for filing an alternate or circling).

14.2.2. Use the ceiling and visibility in parentheses for a circling approach. **(T-1).**

14.2.3. If the reported weather decreases below lowest compatible approach minimums after beginning a descent, receiving radar vectors for an approach, or established on any segment of an approach prior to the missed approach point (MAP), the approach may be continued to the appropriate MAP and a landing may be accomplished if all criteria for landing are met.

14.2.4. Do not fly an approach or land at an airport where thunderstorms or other hazardous conditions are producing hail, strong winds, gust fronts, heavy rain, lightning, wind shear, or microbursts unless the runway and flight path are clear of hazards. **(T-3).**

**14.3. Types of Instrument Arrivals.** Fly all procedures as published. **(T-0).**

14.3.1. Fly conventional arrivals using the appropriate conventional NAVAID(s) as the primary means of navigation except when using substitute or alternate means as authorized with approved RNAV equipment. **(T-0).**

14.3.2. Retrieve PBN procedures in their entirety by procedure name from a current navigation database and compare against approved publications. **(T-0).**

14.3.3. Fly MAJCOM arrivals as authorized by the MAJCOM.

**14.4. VFR Arrival.** When arriving at a controlled airfield, contact ATC (approach or tower) and advise them of call sign, position, and intentions. **(T-0).** ATC allows VFR aircraft to self-navigate to the landing runway when traffic permits.

**14.5. Descent Planning.** [FAA-H-8083-16, Chapter 3] Planning the descent from cruise is important because of the need to dissipate altitude and airspeed to arrive at the approach gate properly configured. To plan the descent, the pilot needs to know the cruise altitude, approach gate altitude or IAF altitude, descent groundspeed, and descent rate.

**14.6. Initial Descent.** Before starting descent, review instrument procedures and weather, check heading and attitude systems, and coordinate lost communication procedures, if necessary. If holding is not required, reduce to maneuvering airspeed before reaching the IAF. During the descent, control descent rate and airspeed to comply with any altitude or speed restrictions imposed by ATC.



**14.7. ICAO Arrival Routing.** Published arrival routing to a course reversal IAF, such as a STAR, feeder route, or arrival airway, is blended into the arrival approach, either by being within the 30 degrees entry sector or a depicted holding pattern entry. Pilots need not request maneuvering airspace to perform an alignment maneuver; such requests may confuse ATC.

**14.8. Standard Terminal Arrivals (STAR).** [ICAO Doc 8168 Volume 1; AIM 5-4-1] A STAR is a designated IFR arrival route linking a significant point, normally on an ATS route, with a point from which a published instrument approach procedure can be commenced. STARs simplify clearance delivery procedures and facilitate the transition between enroute and instrument approach procedures. Pilots should notify ATC if they do not wish to use a STAR by placing “NO STAR” in the remarks section of the flight plan or by the less desirable method of verbally stating the same to ATC.

**14.9. Arrival Clearances.** Pilots navigating on arrival procedures must maintain last assigned altitude until receiving authorization to descend; comply with all restrictions published during the descent. **(T-0).**

**14.10. Arrival Phraseology.**

14.10.1. In the NAS, arrival phraseology is in accordance with [Table 14.1](#)

**Table 14.1. NAS Phraseology.**

| <b>ATC Instruction</b>  | <b>Explanation</b>  |
|---|---|
| “Cleared Tyler One arrival.”  | - Follow the lateral profile of the arrival<br>- No descent is authorized   |
| “Cleared Tyler One arrival, descend and maintain flight level two four zero.”                                       | - Follow the lateral profile of the arrival<br>- Descend to the cleared altitude and maintain this altitude until cleared for further descent with a newly assigned altitude or “descend via”   |
| “Cleared Tyler One arrival, descend at pilot’s discretion, maintain FL180.”   | - Follow the lateral profile of the arrival<br>- Descend at pilot’s discretion to the cleared altitude, maintain this altitude until cleared for further descent with a newly assigned altitude or “descend via”                                    |
| “Descend via the Tyler One arrival.”  | - Follow the lateral profile of the arrival<br>- Descend at pilot’s discretion and comply with published altitude restrictions  |
| “Descend via the Tyler One arrival, except after GRANT maintain nine thousand.”                                     | - Follow the lateral profile of the arrival<br>- Descend at pilot’s discretion and comply with published altitude restrictions until the ATC-assigned “maintain” altitude   |
| “Descend via the Tyler One arrival, except cross SCOTT at nine thousand then maintain six thousand.”                | - Follow the lateral profile of the arrival<br>- Descend at pilot’s discretion and comply with published altitude restrictions, cross the point at the ATC-assigned altitude, and then continue the descent to the ATC-assigned “maintain” altitude |
| “Proceed direct DILLY, cross DILLY at or above flight level two zero zero, then descend via the Tyler One arrival.” | - Proceed direct to the assigned point<br>- Follow the lateral profile of the arrival<br>- Descend at pilot’s discretion to the published or assigned altitude at the ATC-assigned point then comply with published altitude restrictions.          |
| <b>Note:</b> Always comply with speed restrictions or ATC-issued speed control instructions, as applicable.         |   |

14.10.2. [ICAO Doc 4444] (ICAO) ATC clearances issued to aircraft on a STAR include if remaining speed or level restrictions are to be followed or cancelled; standard clearance phraseology is shown in [Table 14.2](#)

14.10.2.1. If there are no remaining published level or speed restrictions on the STAR, the phrase “DESCEND TO (*level*)” should be used.

14.10.2.2. When subsequent speed restrictions instructions are issued and if the cleared level is unchanged, the phrase “DESCEND VIA STAR TO (*level*)” should be omitted.

14.10.2.3. When an arriving aircraft is cleared to proceed direct to a published waypoint on the STAR, the speed and level restrictions associated with the bypassed waypoints are cancelled. All remaining published speed and level restrictions remain applicable.

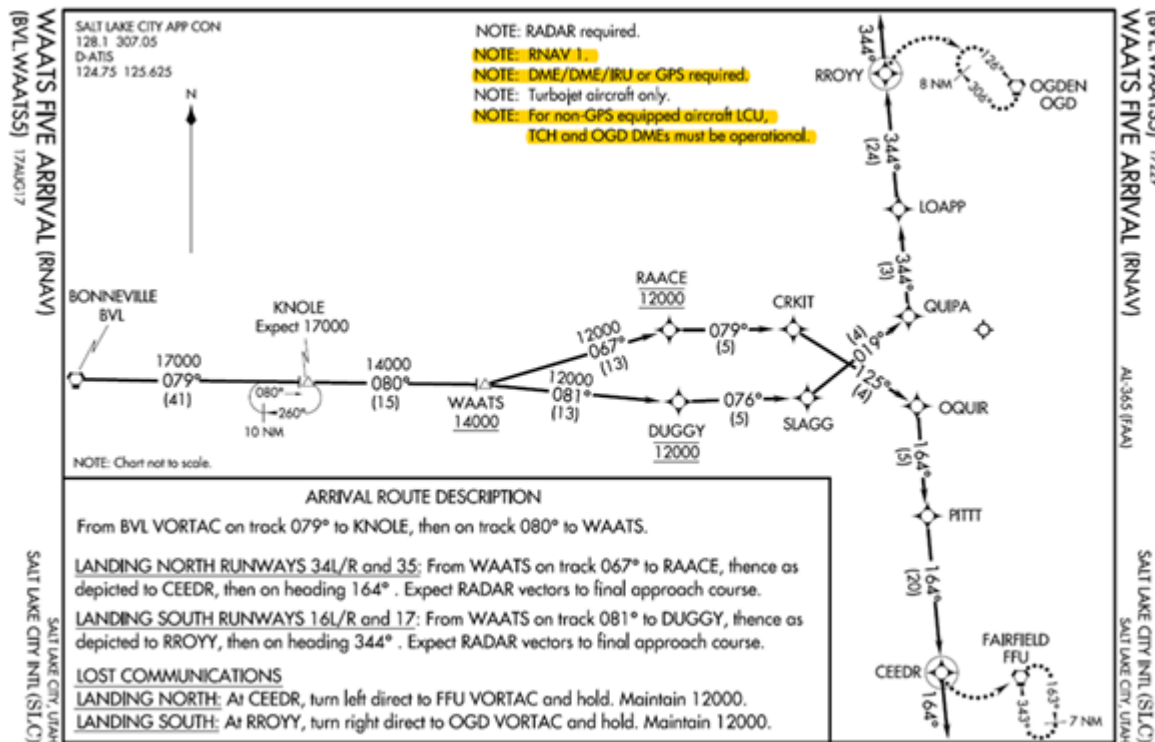
14.10.2.4. ATC instructions to rejoin a STAR after being vectored include the STAR to be rejoined, the cleared level to rejoin the STAR unless advance notification has been provided, and the position to rejoin the STAR.

**Table 14.2. ICAO Phraseology.**

| ATC Instruction  | Explanation   |
|--|---|
| “Descend via STAR to <i>(level)</i> ”  | <ul style="list-style-type: none"> <li>- Follow the lateral profile of the STAR</li> <li>- Descend to the cleared level and comply with published level restrictions</li> </ul>   |
| Descend via STAR to <i>(level)</i> , cancel level restriction(s)   | <ul style="list-style-type: none"> <li>- Follow the lateral profile of the STAR</li> <li>- Descend to the cleared level and published level restrictions are cancelled</li> </ul>   |
| Descend via STAR to <i>(level)</i> , cancel level restriction(s) at <i>(point(s))</i>                              | <ul style="list-style-type: none"> <li>- Follow the lateral profile of the STAR</li> <li>- Descend to the cleared level and published level restrictions at the specified point(s) are cancelled</li> </ul>   |
| Descend via STAR to <i>(level)</i> , cancel speed restriction(s)   | <ul style="list-style-type: none"> <li>- Follow the lateral profile of the STAR</li> <li>- Descend to the cleared level and comply with published level restrictions</li> <li>- Published speed restrictions and ATC-issued speed control instructions are cancelled</li> </ul> |
| Descend via STAR to <i>(level)</i> , cancel speed restriction(s) at <i>(point(s))</i>                              | <ul style="list-style-type: none"> <li>- Follow the lateral profile of the STAR</li> <li>- Descend to the cleared level and comply with published level restrictions</li> <li>- Published speed restrictions are cancelled at the specified point(s)</li> </ul>                 |
| Descend unrestricted to or descend to <i>(level)</i> , cancel level and speed restrictions                         | <ul style="list-style-type: none"> <li>- Follow the lateral profile of the STAR</li> <li>- Descend to the cleared level, published level restrictions are cancelled</li> <li>- Published speed restrictions and ATC-issued speed control instructions are cancelled</li> </ul>  |
| <p><b>Note:</b> Always comply with speed restrictions or ATC-issued speed control instructions, as applicable.</p> |   |

**14.11. RNAV Arrivals.** [AIM 5-4-1; ICAO Doc 8168 Volume 1; FAA Order 8260.19] RNAV arrivals may be RNAV 1 or RNP 1 (**Figure 14.1**). The default specification is RNAV 1; RNP 1 is used when an arrival contains an RF leg or is designed for DME/DME/IRU aircraft use when ATC radar surveillance monitoring is not desired. **Note:** The required specification, equipment sensor limitations, and any critical DME facilities are annotated clearly on the procedure.

Figure 14.1. RNAV Arrival.



**14.12. Anticipated Approach.** ATC should provide the type of approach to expect, or if vectors should be expected for a visual approach when landing at airfields with two or more published instrument procedures. This information is broadcast either by a controller or on ATIS. It is not provided when the visibility is three miles or better and the ceiling is at or above the highest initial approach altitude established for any low altitude instrument procedures for the airfield. When making an IFR approach to an airfield not served by a tower or FSS, after ATC advises “change to advisory frequency approved”, the pilot should broadcast their intentions. This should include the type of approach being executed, position, and when over the non-precision approach final approach fix (FAF) inbound or at the precision approach glideslope intercept point. Monitor the appropriate frequency (e.g., UNICOM) for reports from other pilots.

**14.13. Terminal Routings.** Terminal routings from enroute or feeder facilities are considered segments of instrument procedures and normally provide a course, range, and minimum altitude to the IAF. They may take the aircraft to a point other than the IAF if it is operationally advantageous to do so. A low altitude IAF is any fix labeled as an IAF or any procedure turn or hold-in-lieu-of procedure turn (HILPT) fix.

14.13.1. Ranges published along the terminal routing are expressed in nautical miles and not DME. The altitudes published on terminal routing are minimum altitudes and provide the same protection as an airway MEA (i.e., for navigation signal coverage and obstacle clearance).

14.13.2. If cleared for an approach while enroute to a holding fix that is not collocated with the IAF, either proceed via the holding fix or request clearance direct to the IAF. If the IAF is located along the route of flight to the holding fix, begin the approach at the IAF. If overflying a transition fix, fly the approach via the terminal routing. If in doubt as to the clearance, query the controller.

14.13.3. When cleared for the approach, maintain the last assigned altitude until established on a segment of a published route or instrument procedure. At that time, the pilot may descend to the minimum altitude associated with that segment of the published routing or instrument approach procedure.

**14.14. Terminal Arrival Area (TAA).** [AIM 5-4-5, ICAO Doc 8168 Volume 1, Section 1, Chapter 2] The TAA provides a transition from the enroute structure to the terminal environment for aircraft equipped with RNAV systems. TAAs are primarily used on RNAV approaches but may be used on instrument procedures when area navigation is the sole means for navigation to the intermediate fix (IF)/IAF.

**14.15. Radar Vectors.** [AIM 5-4-3] Vectors provide course guidance and expedite traffic to the final approach course of any published instrument procedure or to the traffic pattern for a visual approach.

14.15.1. [ICAO] [ICAO Doc 8168 Volume 1, Section 3, Chapter 1] With GNSS equipment, it may be required to manually select the next waypoint so that the GNSS is correctly using the appropriate database points and associated flight paths.

14.15.2. [ICAO] [ICAO Doc 8168 Volume 1, Section 4, Chapter 2] When terminal area radar is employed, the aircraft is vectored to a fix, or onto the intermediate or final approach track, at a point where the approach may be continued by the pilot referring to the instrument approach chart.

14.15.3. [AIM 5-4-5] Radar Controllers use an MVA chart to provide obstacle clearance while vectoring for an approach.

14.15.4. At all other times, unless specifically requested by the pilot, an aircraft is vectored to intercept the final approach course at least 3 miles from the FAF at a maximum intercept angle of 45 degrees (30 degrees in the NAS).

14.15.5. [FAA-H-8083-16, Chapter 4] Controllers are required to ensure the assigned altitude conforms to the following:

14.15.5.1. At an altitude not above the glideslope or glidepath, nor below the minimum glideslope or glidepath intercept altitude specified on the procedure for a precision approach.

14.15.5.2. At an altitude that allows descent in accordance with the published procedure for a non-precision approach.

14.15.6. Aircraft are normally informed when it is necessary to vector across the final approach course for spacing or other reasons. If approach course crossing is imminent and the pilot has not been informed that the aircraft is being vectored across the final approach course, the pilot should query the controller. Do not turn inbound on the final approach course unless an approach clearance has been issued. Approach clearance is normally issued with the final vector for interception of the final approach course, and the vector enables the aircraft to intercept the final approach course prior to reaching the FAF.

14.15.7. The pilot must maintain the last assigned altitude and heading until established on a segment of a published instrument procedure once approach clearance is received. **(T-0)**. Comply with all course and altitude restrictions as depicted on the approach procedure; pilots

must not climb above the last assigned altitude to comply with published altitude restrictions unless so instructed by the controlling agency. **(T-0)**.

**14.16. Operating at Non-towered Airfields.** [AIM 4-1-9; AIM 4-3-3] All CTAF and FSS calls will be in accordance with the AIM. **(T-0)**. **Note:** Personnel providing traffic advisories at non-towered airfields are not ATC. Pilots are responsible for their own traffic avoidance, sequencing, and separation. Instrument approaches may not coincide with the ground tracks of the VFR traffic pattern, the instrument approach may not terminate at the active runway, altitudes may not coincide with the prevailing traffic patterns, and not all VFR pilots are familiar with the instrument approach procedures at the airfield.

14.16.1. Aircraft operating on an IFR flight plan, landing at a non-towered airfield are advised to “change to advisory frequency” when ATC communications are no longer required. When directed, pilots should expeditiously change to the CTAF, as the ATC facility may not have runway in use or airfield traffic information.

14.16.2. In addition to required VFR CTAF calls, make position reports at the following locations on the approach:

14.16.2.1. Departing the FAF inbound.

14.16.2.2. Established on the final approach segment or immediately upon being released by ATC.

14.16.2.3. Completion or termination of the approach.

14.16.2.4. Executing the missed approach procedure.

14.16.3. Many VFR pilots operating near the airfield may not be familiar with fix names. Location should be referred to in the simplest terms. For example, use “5 miles south” instead of “ALEXX Intersection.”

## Chapter 15

### APPROACH

**15.1. General.** Instrument procedures provide necessary navigation guidance information for alignment with the final approach courses as well as obstruction clearance. An instrument procedure can be flown in one of two ways: as a “full procedure” approach or with the assistance of ATC via radar vectors. Full procedure approaches may be requested by the pilot but are most often used in areas without radar coverage. A full procedure approach also provides the pilot with a means of completing an instrument approach in the event of a communication failure.

15.1.1. Reference AIM 5-4, FAA-H-8083-16 Chapters 4 and 7, and ICAO Doc 8168 Volume 1 Section 4 for more detailed explanations of arrival procedures.

15.1.2. [AIM 5-4-5] A precision approach is an instrument approach based on a navigation system that provides course and glidepath deviation information meeting the precision standards of ICAO Annex 10 (i.e., PAR, ILS, and GLS).

15.1.3. [AIM 5-4-5] An approach with vertical guidance (APV) is an instrument approach based on a navigation system that is not required to meet the precision approach standards of ICAO Annex 10, but provides course and glidepath deviation information (e.g., baro-VNAV, LDA with glideslope, LNAV/VNAV, LPV).

15.1.4. [AIM 5-4-5] A non-precision approach is an instrument approach based on a navigation system which provides course deviation information, but no glidepath deviation information (e.g., VOR, NDB, LNAV). Some approach procedures may provide a vertical descent angle (VDA) as an aid in flying a stabilized approach, without requiring its use to fly the procedure. This does not make the approach an APV procedure, since it must still be flown to an MDA and has not been evaluated with a glidepath.

**15.2. Practice Instrument Approaches Under VFR.** When authorized by the MAJCOM, the PIC will:

**15.2. (AFMC) Practice Instrument Approaches Under VFR.** Pilots are authorized to conduct practice instrument approaches under VFR.

15.2.1. Maintain VFR cloud clearances and visibilities in accordance with [Table 12.1](#) or [Table 12.2 \(T-0\)](#);

15.2.2. Use terminal radar services when available;

15.2.3. Make all position reports in accordance with [paragraph 14.16.1.2 \(T-1\)](#); and

15.2.4. Receive ATC approval to fly the published missed approach **(T-0)**.

**15.3. Instrument Approaches.** Fly all procedures as published. **(T-0)**.

15.3.1. **Conventional and Radar Approaches.** Fly these procedures using the appropriate conventional NAVAID(s) as the primary means of navigation except when using substitute or alternate means as authorized with approved RNAV equipment. **(T-0)**. **Note:** Single-piloted operations on (SA) CAT I ILS approaches are prohibited. **(T-0)**.

15.3.2. **PBN Approaches.** Retrieve PBN procedures in their entirety by procedure name from a current navigation database and compare against approved publications. **(T-0)**. **Note:**



MAJCOMs may operationally certify aircrew and aircraft to fly PBN segments on conventional final approaches.

**15.3.3. Self-Contained Approaches.** MAJCOMs will develop and publish design criteria and processing. When unable to develop a procedure in accordance with AFMAN 11-230, see MAJCOM-Certified Procedures [paragraph 15.3.7](#).

**15.3.3. (AFMC)** Aircrew are authorized to accomplish self-contained approaches. Flight conditions will be VMC unless the approach is TERPS-certified according to AFMAN 11-230. UAS platforms should fly the three-dimensional track of a published approach if an appropriate one is available. If no published approach is available, or if a valid operational requirement exists, SCAs for UAS platforms will be constructed in accordance with the procedures outlined in AFMAN 11-2FTV3. **(T-2)**. SCAs developed IAW AFI 11-230 are approved for use in IMC. Weather minima for these approaches must be published in AFMAN 11- 2FTV3. **(T-2)**.

**15.3.4. Precision Runway Monitoring (PRM) Approaches.** Pilots will not participate in PRM approaches without MAJCOM training and certification. **(T-0)**.

**15.3.4. (AFMC)** PRM approaches may be flown provided the aircraft is equipped with required avionics to include dual VHF radios and PRM training is accomplished and documented.

**15.3.5. Simultaneous Offset Instrument Approaches (SOIA).** Pilots will not fly SOIA procedures without MAJCOM training and certification. **(T-0)**.

**15.3.5. (AFMC)** SOIA approaches may be flown provided the aircraft is equipped with required avionics to include dual VHF radios and SOIA training is accomplished and documented.

**15.3.6. Authorization Required Procedures.** Pilots will not fly any RNP “AUTHORIZATION REQUIRED”, conventional “SPECIAL AUTHORIZATION”, or any procedure with a note requiring specific authorization without MAJCOM training and operational approval. **(T-1)**. MAJCOMs comply with the operational approval process outlined in [paragraph 2.2.17](#). **Note:** Single-piloted operations on (SA) CAT I ILS approaches are prohibited. **(T-0)**.

**15.3.7. MAJCOM-Certified Procedures.** MAJCOM/A3s may develop and authorize an approach procedure for use in IMC for their aircraft. These procedures may be performed after completing MAJCOM-specific training **(T-1)** and:

15.3.7.1. With appropriate airspace authority approval (e.g., ATC, Airspace Control Order, host-nation agreement);

15.3.7.2. In conjunction with a compatible published instrument approach procedure;

15.3.7.3. In special use airspace; or

15.3.7.4. Under VFR.

15.3.7.5. **(Added-AFMC)** Approved AFMC-certified procedures will be published in the MDS-attachments to AFMAN 11-2FTV3.

15.3.8. **Helicopter Procedures.** [AIM 10-1-2, 14 CFR Part 97.3] Apply limitations in accordance with **Table 15.1 (T-0)**. Apply any inoperative approach lighting visibility correction before reducing minimums. **(T-0)**.

15.3.8.1. Do not reduce the visibility minimums on “COPTER”, Category II, Category III, and circling procedures or if “Visibility Reduction by Helicopters NA” is annotated on the procedure. **(T-0)**.

**Table 15.1. Helicopter Use of Approach Procedures.**

| Procedure                        | Helicopter Visibility   | Helicopter MDA/DA           | Maximum Speed Limitations   |
|----------------------------------|---|-----------------------------|---|
| <b>Conventional (non-Copter)</b> | The greater of:<br>one-half the Category A visibility minimums, or<br>$\frac{1}{4}$ SM visibility, or<br>1200 RVR | As published for Category A | Initiate the final approach segment at speeds up to the upper limit of the highest Approach Category authorized by the procedure, but must be slowed to no more than 90 knots indicated airspeed (KIAS) at the MAP in order to apply the visibility |
| <b>Copter Procedure</b>          | As published  | As published                | 90 KIAS when on a published route or track  |
| <b>GPS Copter Procedure</b>      | As published  | As published                | 90 KIAS when on a published route or track, EXCEPT 70 KIAS when on the final approach or missed approach segment and, if annotated, in holding. Military procedures are limited to 90 KIAS for all segments.  |

#### 15.4. Approach Minimums.

15.4.1. Do not descend below the MDA, DA, or DH unless sufficient visual reference with the runway environment has been established and the aircraft is in a position to execute a safe landing. **(T-1)**. See **paragraph 16.7** for additional guidance.

15.4.2. Do not descend below 100 feet above the threshold elevation or touchdown zone elevation (TDZE) using the approach lights as a reference unless the red termination bars or the red side row bars are visible and identifiable. **(T-1)**.

**15.5. Inoperative Approach Lighting System (ALS).** Apply corrections as published in DoD FLIP Inoperative Components Table. **(T-0)**.

**15.6. Approach Clearance.** [AIM 5-4-5; AIM 5-4-6] The controller issues an approach clearance only after the aircraft is established on a segment of the instrument procedure; or the

aircraft is assigned an altitude and heading to maintain until established on a segment of the instrument procedure.

15.6.1. [14 CFR Part 91.175(i)] Maintain the last assigned altitude when cleared for the approach until established on a published segment of the instrument approach procedure. **(T-0). Note:** Once cleared for the approach, pilots may descend once inside a TAA sector to the minimum altitude depicted unless otherwise instructed by ATC.

15.6.2. Approach clearances cancel any previously assigned airspeed adjustments. Pilots are expected to make their own airspeed adjustments to complete the approach unless the adjustments are restated. Speed adjustments should not be assigned inside the FAF or a point 5 miles from the runway, whichever is closer to the runway. The pilots always retain the prerogative of rejecting a speed adjustment by ATC if the minimum safe airspeed for any operation is greater than the speed adjustment.

15.6.3. [ICAO] When clearance for the approach is issued, ATC expects the pilot to initiate the approach in accordance with the instrument procedure entry criteria.

**15.7. Aircraft Speed.** The pilot should slow the aircraft in accordance with aircraft flight manual prior to reaching the IAF. A stabilized approach inside the IAF is critical for a successful approach and landing. ICAO maximum speeds are listed in [Table 15.2](#)

**Table 15.2. ICAO Maximum Speeds.**

| Aircraft Category   | Range of Speeds for Initial Approach Segment (KIAS) | Range of Speeds for Final Approach Segment (KIAS) |
|---|---|---|
| A   | 90 to 150 (110*)                                    | 70 to 100   |
| B   | 120 to 180 (140*)                                   | 85 to 130   |
| C   | 160 to 240  | 115 to 160  |
| D   | 185 to 250  | 130 to 185  |
| E   | 185 to 250  | 155 to 230  |
| H   | 70 to 120**   | 60 to 90**  |
| CAT H (PinS)***   | 70 to 120   | 60 to 90  |
| <p>* Maximum speed for reversal and racetrack procedures.</p> <p>** Maximum speed for reversal and racetrack procedures up to and including 6,000 feet is 100 knots and maximum speed for reversal and racetrack procedures above 6,000 feet is 110 knots.</p> <p>*** Helicopter "Point-in-space" (PinS) procedures based on basic GNSS may be designed using maximum speeds of 120 knots for initial and intermediate segments and 90 knots on final and missed approach segments, or 90 knots for initial and intermediate segments and 70 knots on final and missed approach segments depending on the operational need.</p> |   |   |

**15.8. Approach Chart Naming Convention.** [FAA-H-8083-16; ICAO Doc 8168 Volume 1, Section 4, Chapter 8] Approach charts are identified by their procedure name (based on the NAVAIDs required for the final approach), runway served, and airfield locations.

**15.9. Duplicate Procedure Identification.** [ICAO Doc 8168 Volume 1, Section 4, Chapter 8] When two or more straight-in approaches with the same type of navigation guidance exists for the same runway a letter or numerical suffix is added to the title of the approach (e.g., VOR Z RWY 20, VOR Y RWY 20). The single letter suffix is used when:

15.9.1. Two or more NAVAIDs of the same type are used to support different approaches to the same runway;

15.9.2. Two or more missed approaches are associated with a common approach, each approach is identified by a single letter suffix;

15.9.3. Different approach procedures using the same navigation type are provided for different aircraft categories; or

15.9.4. Two or more arrivals are used to a common approach and are published on different charts.

**15.10. Circling-Only Approach.** [FAA-H-8083-16; ICAO Doc 8168 Volume 1, Section 4, Chapter 8] The name of the approach is followed by a single letter starting with the letter “A” when only circling minimums are provided on an instrument approach. The suffix letter is not used again for any procedures at that airfield.

**15.11. Equipment Required for an Approach.** [ICAO Doc 8168 Volume 1] A slash (/) indicates that more than one type of equipment may be required to execute the final approach (**Figure 15.1**). Additional equipment may be required to execute the other portions of the procedure (**Figure 15.2**). All navigation equipment that is required for the execution of the approach procedure and not mentioned in the procedure identification should be identified in the notes on the chart. In general, a note charted on the plan view (e.g., RADAR REQUIRED) indicates equipment that is required to transition from the enroute environment to the instrument procedure.

Figure 15.1. Equipment Required for an Approach.

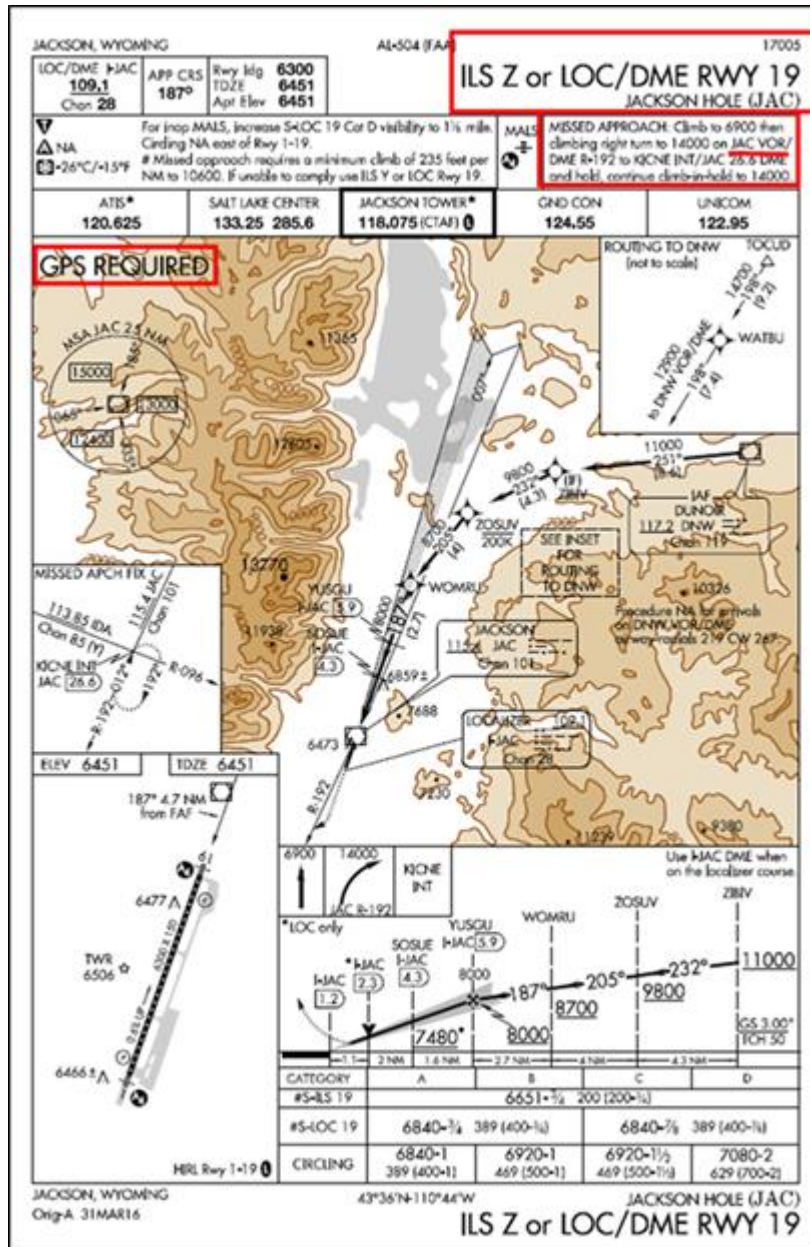
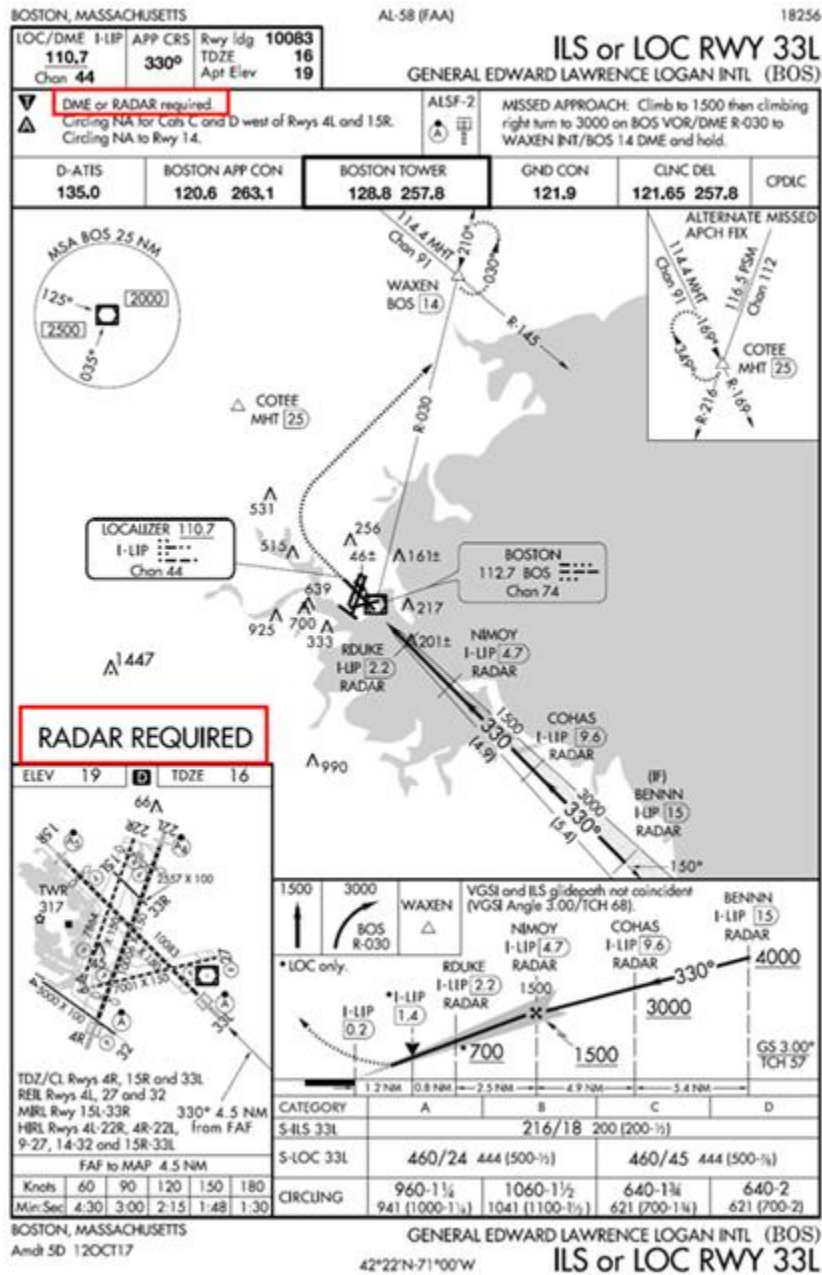





Figure 15.2. Additional Equipment Required for Approach.



**15.12. Radar Approaches.** Radar minima, circling MDA, and glideslope angle are in the front of the terminal procedures publication (Figure 15.3).

Figure 15.3. Radar Approach Minimums.

| PORTSMOUTH, NH   |            | Amdt 1, 05JUN08 (14261) (FAA) |            |                        | ELEV 100                      |                 |
|--|------------|-------------------------------|------------|------------------------|-------------------------------|-----------------|
| PORTSMOUTH INTL AT PEASE (PSM)   |            |                               |            |                        |                               |                 |
| RADAR-1 125.05 269.4  |            |                               |            |                        |                               |                 |
|  | <u>RWY</u> | <u>GP/TCH/RPI</u>             | <u>CAT</u> | <u>DA/<br/>MDA-VIS</u> | <u>HAT/<br/>HATH/<br/>HAA</u> | <u>CEIL-VIS</u> |
| PAR  | 34         | 3.0°/64/1221                  | ABCDE      | 284/24                 | 200                           | (200-½)         |
| ASR  | 16         |                               | ABC        | 520/40                 | 420                           | (500-¾)         |
|  |            |                               | DE         | 520/50                 | 420                           | (500-1)         |
|  | 34         |                               | ABC        | 560/40                 | 476                           | (500-¾)         |
|  |            |                               | D          | 560/50                 | 476                           | (500-1)         |
|  |            |                               | E          | 560/60                 | 476                           | (500-1¼)        |

**15.13. Non-radar Approaches.** Non-radar approaches are defined as approaches that do not require radar vectoring or radar services on final approach and may or may not provide vertical glideslope or glidepath guidance. Examples of non-radar approaches include ILS, LOC, VOR, TACAN, NDB, RNAV, and GLS.

**15.14. Reading an Instrument Procedure.** [FAA-H-8083-16, Chapter 4; DoD Publications Product Specifications paragraph 303] Refer to [Figure 15.4](#).

15.14.1. The pilot briefing area consolidates information necessary to conduct the approach in one location. It includes final approach course, runway and airfield data, procedure restrictions, approach light data, missed approach text, and various radio frequencies.

15.14.2. The plan view provides a pictorial depiction of the instrument procedure; it may be depicted with or without concentric rings.

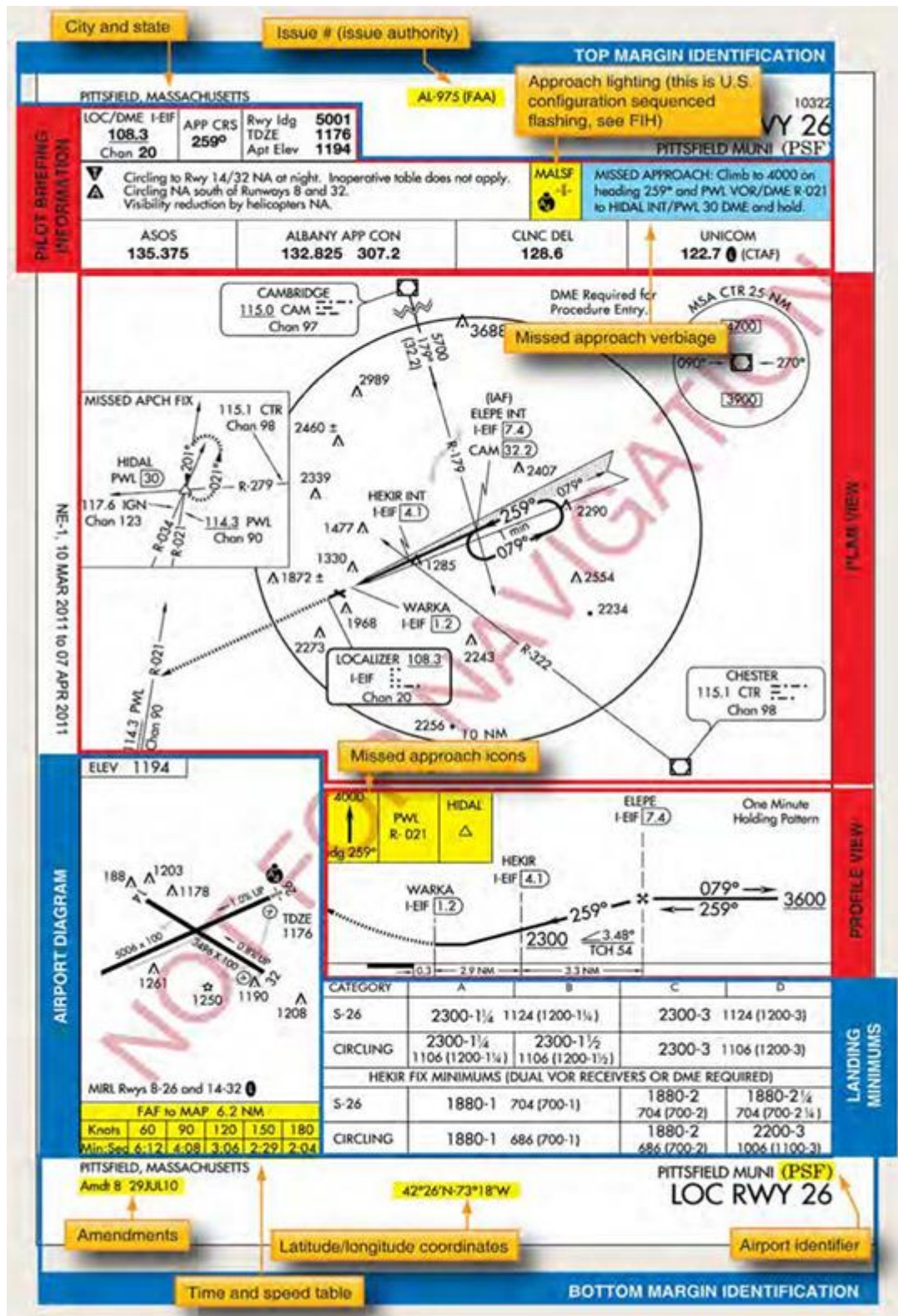
15.14.2.1. The plan view is depicted without concentric rings when all the procedural and terminal route information can be depicted to scale.

15.14.2.2. Concentric rings are used when all procedural and terminal route information cannot be depicted to scale. A 10 nautical mile distance ring is shown when necessary; all information within the 10 nautical mile distance ring is shown to scale. **Note:** A 20 nautical mile distance ring replaces the 10 nautical mile distance ring on high procedures.

15.14.2.3. Additional rings are not depicted to scale.



Figure 15.4. Instrument Approach Chart.

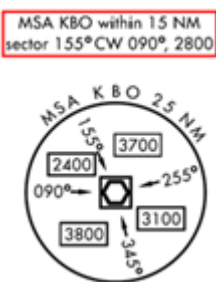


15.14.3. An emergency safe altitude (ESA) is normally published only for U.S. military procedures; it is a single altitude that provides 1,000 feet of obstacle clearance (2,000 feet in

designated mountainous areas) within 100 nautical miles of the facility or fix. **Note:** Canada and other ICAO States publish a “safe altitude within 100 NM” on civil or military instrument procedures; it provides the same obstacle clearance.

15.14.4. The minimum sector altitude provides at least 1,000 feet of obstacle clearance within 25 nautical miles (on conventional navigation systems this radius may be expanded to 30 nautical miles if necessary to encompass the airfield landing surfaces) of the facility or fix. The minimum sector altitude may be further divided into a maximum of four sectors when more than one minimum sector altitude is required. At some airfields the minimum sector altitudes may have sub-sectors based on distances (**Figure 15.5**). **Note:** Minimum sector altitudes do not guarantee NAVAID reception.

**Figure 15.5. Minimum Sector Altitude with Sub-sector Based on Distance.**



15.14.5. The profile view provides a side view of prescribed altitudes, descent gradients, and a pictorial representation of the missed approach procedures.

15.14.5.1. Vertical descent angles are calculated to provide a constant descent rate in the final segment. The optimum VDA is 3.00 degrees. Where operationally feasible, straight-in non-precision approaches (all categories) have a VDA equal to the commissioned angle of an installed visual glideslope indicator (VGSi). An approach without a FAF does not have a VDA.

15.14.5.2. The threshold crossing height (TCH) refers to the point where the VDA crosses above the threshold. The typical TCH is 30 to 50 feet unless required by larger type aircraft.

15.14.6. The airfield diagram depicts field elevation, TDZE, runway dimensions, lighting systems, obstructions, and final approach direction. **Note:** Not all obstructions are depicted; check NOTAMs, Enroute Supplement, etc.

15.14.6.1. The field elevation is the highest point on any usable landing surface.

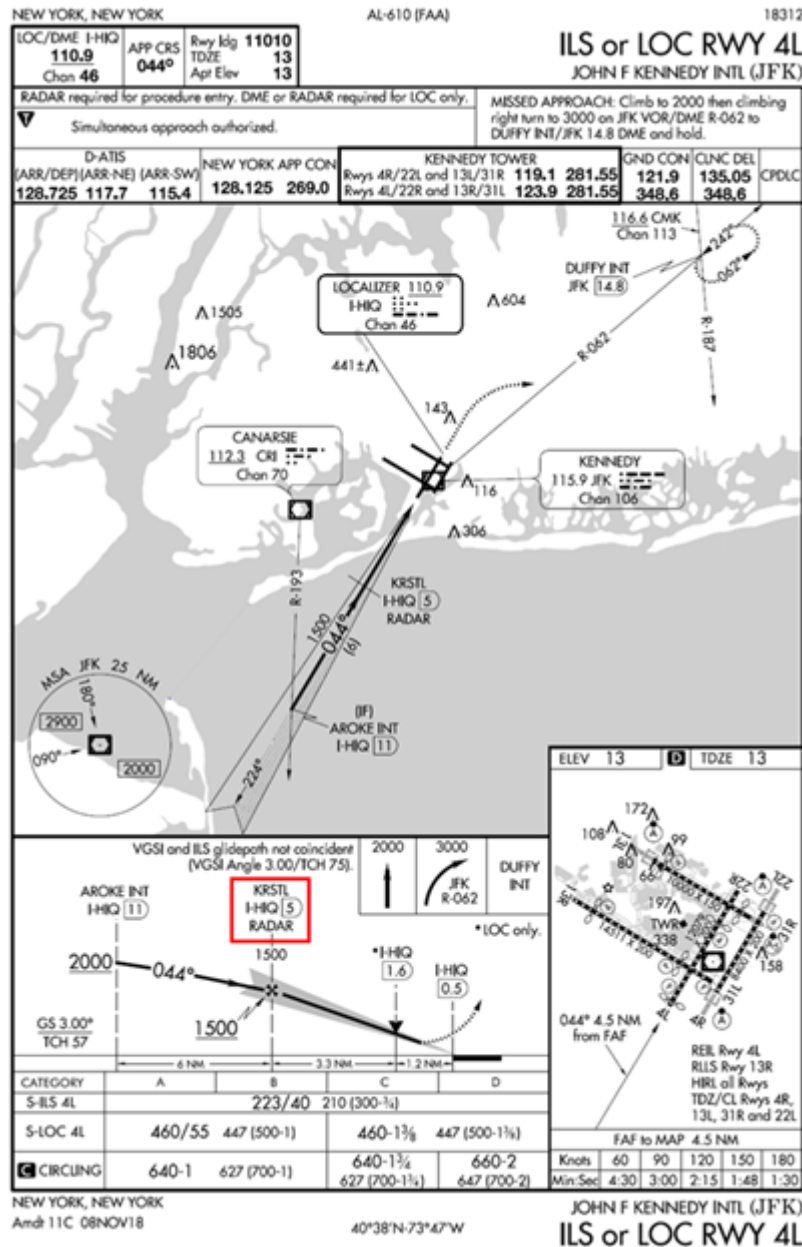
15.14.6.2. The touchdown zone elevation is the highest point in the first 3,000 feet of the landing surface.

15.14.6.3. The arrow shows the direction of the final approach in relation to the runway orientation. A final approach may be as much as 30 degrees off of the runway centerline and still be considered a straight-in approach.

15.14.7. Look carefully for notes on the instrument procedure. Notes are used to identify either nonstandard instrument procedure criteria or to emphasize areas essential for the safe completion of the approach.

**15.15. Radar Fixes on Non-radar Approaches.** Fixes that may utilize ATC radar for fix identification purposes are depicted with the word “RADAR” (Figure 15.6). Pilots are provided with navigation guidance and fix identification when transiting segments labeled with “RADAR.”

**Figure 15.6. Radar Fix on Non-radar Approach.**



**15.16. PBN Transitions to Conventional Final Approach.** [ICAO Doc 8168 Volume 2; AC 90-105; AC 90-108; FAA Order 8260.58] Some published approaches may combine area navigation initial, intermediate, or missed approach segments with a conventional final approach segment (Figure 15.7). The PBN segments are designed under RNAV 1 or RNP 1 criteria. These approach procedures are expected to be extracted, in their entirety, from a valid and certified database without alteration.

15.16.1. Aircraft must be operationally certified, and aircrew must be trained and approved to fly PBN transition to conventional final approaches as applicable by their respective MAJCOMs. **(T-0)**.

15.16.2. Pilots must ensure information from the correct navigation source is displayed (e.g., PBN source for PBN segments). **(T-0)**.

15.16.3. [AIM 1-2-3] Pilots will transition aircraft navigation from PBN to conventional course guidance prior to the FAF. **(T-0)**. **Exception:** MAJCOMs may authorize pilots to use a suitable RNAV system or RNP system to navigate on the final approach segment of a conventional instrument approach procedure based on a VOR, TACAN, or NDB. The underlying NAVAID must be operational and the NAVAID monitored for final segment course alignment. **(T-0)**.

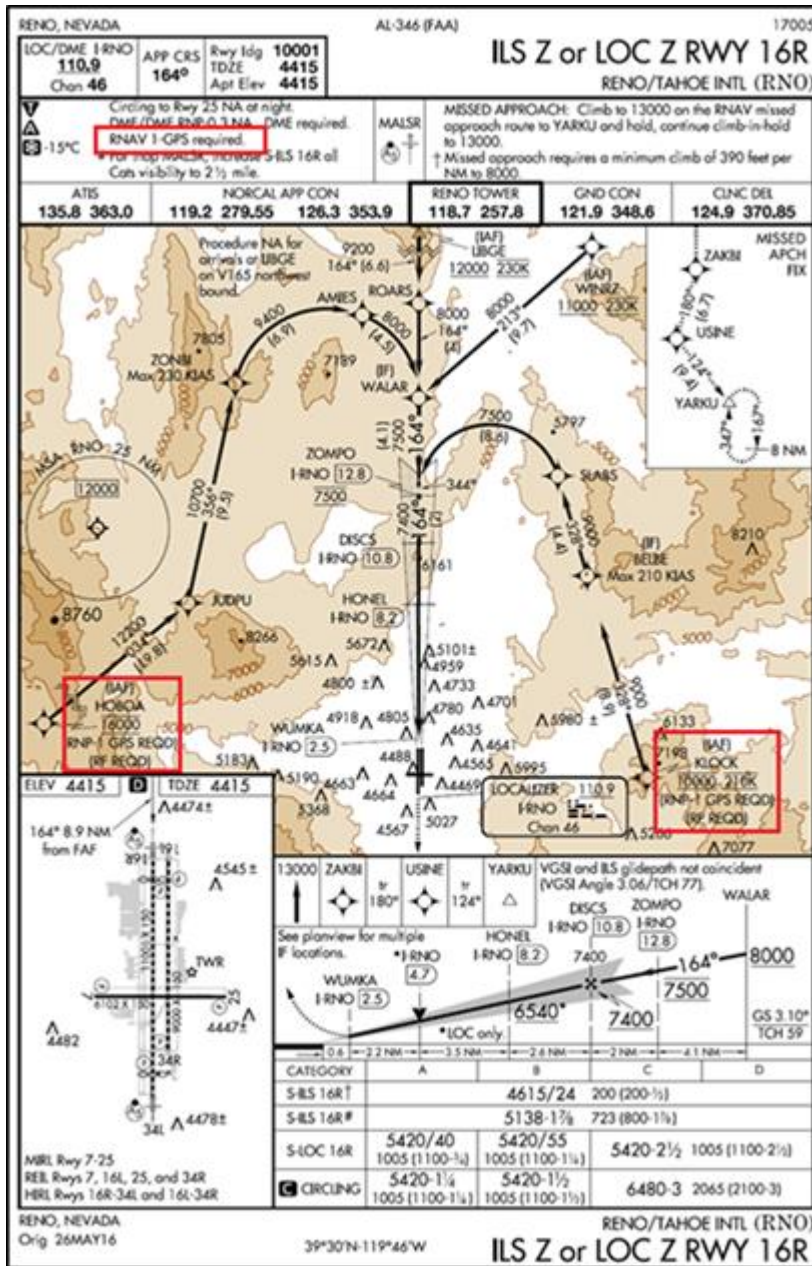
15.16.4. Many USAF aircraft do not have conventional instrument procedures in the navigation database. Pilots may still request or accept radar vectors to the conventional final approach segment when there is no fully conventional approach to the same runway if:

15.16.4.1. The pilot coordinates for alternate missed approach instructions; or

15.16.4.2. The missed approach segment is conventional.

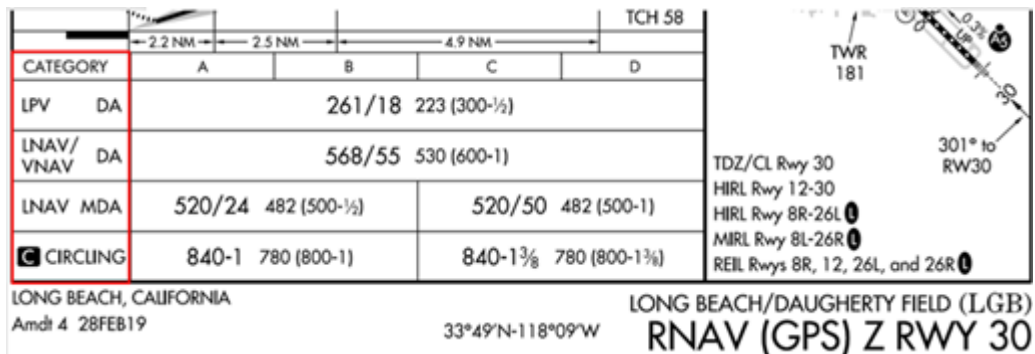


Figure 15.7. PBN Transitions to Conventional Final Approach.



**15.17. RNAV Lines of Minima.** [AIM 5-4-5] Each line of minima on an RNAV instrument procedure is titled to reflect the level of service required (Figure 15.8). The minima are dependent on the navigation equipment capability as outlined in the IFR LANDING MINIMA section at the front of the terminal procedures publication. Typically, the approach chart indicates the equipment required for the approach (e.g., GPS, RNP-0.3).

Figure 15.8. RNAV Lines of Minima.



15.17.1. The LPV level of service provides lateral and VNAV guidance; it is an APV and the line of minima is published as a DA. LPV takes advantage of the improved accuracy of SBAS lateral and vertical guidance to provide an approach that is very similar to a CAT I ILS. LPV approaches are designed for angular guidance with increasing sensitivity as the aircraft gets closer to the runway; this sensitivity is nearly identical to an ILS at similar distances from the runway. **Note:** Pilots will not use the LPV line of minima unless the aircraft flight manual states installed equipment supports LPV approaches. **(T-0).**

15.17.2. The LP level of service provides LNAV guidance only; it is a non-precision approach and the line of minima is published as an MDA. LP takes advantage of the improved accuracy of SBAS to provide approaches with angular lateral guidance; therefore, lateral sensitivity increases as the aircraft gets closer to the runway, similar to localizer approaches.

15.17.2.1. LP is only published when terrain, obstructions, or other reasons prevent publishing a vertically guided procedure; LP is not published with another approach that contains approved vertical guidance (i.e., LPV or LNAV/VNAV). LP is published in addition to LNAV only when it provides lower minimums.

15.17.2.2. LP is not a fail-down mode for LPV. A SBAS receiver may not support LP even if it supports LPV.

15.17.2.3. Pilots will not use the LP line of minima unless the aircraft flight manual includes LP as an approved approach type. **(T-0).**

15.17.2.4. Some SBAS avionics provide LP with advisory vertical guidance (LP+V); pilots will only use advisory vertical guidance for situational awareness to the LP MDA. **(T-0).**

15.17.3. The LNAV/VNAV level of service provides lateral and vertical navigation guidance; it is an APV and the line of minima is published as a DA. Vertical guidance is usually provided by approach-certified Baro-VNAV but with lateral and vertical integrity limits larger than a precision approach or LPV. **Note:** Pilots will not use the LNAV/VNAV line of minima unless the aircraft flight manual states the aircraft has been demonstrated to support LNAV/VNAV approaches or the installed equipment supports GNSS approaches with approach-approved Baro-VNAV. **(T-0).**


15.17.4. The LNAV level of service provides LNAV guidance only; it is a non-precision approach and the line of minima is published as an MDA. **Note:** Some RNAV systems present

LNAV with advisory vertical guidance (LNAV+V); pilots will only use advisory vertical guidance for situational awareness to the LNAV MDA. **(T-0)**.

**15.18. Baro-VNAV Systems.** Baro-VNAV systems compute vertical guidance referenced to a specified vertical path angle (VPA). The computer-resolved vertical guidance is based on aircraft barometric altimetry systems. This VPA may be greatly affected by non-standard temperatures, incorrect or rapidly changing altimeter settings, and altimeter error. Pilots must not use Baro-VNAV guidance for reference below the published DA. **(T-0)**. Pilots should closely monitor compliance with step down fix altitude constraints. **Note:** Deviations from the VNAV path are often linear as opposed to angular (i.e., one dot deviation represents a fixed number of feet from the vertical path regardless of distance to the runway waypoint).

**15.19. Baro-VNAV Temperature Limitations.** [FAA-H-8083-16, Chapter 4] A minimum and maximum temperature limitation is published on procedures that authorize Baro-VNAV operation (**Figure 15.9**). These temperatures represent the airfield temperature above or below which Baro-VNAV is not authorized to LNAV/VNAV minimums unless temperature compensation can be accomplished.

**Figure 15.9. Baro-VNAV Temperature Limits.**

| LONG BEACH, CALIFORNIA  |                                 |  | AL-236 (FAA)  | 19171   |                  |  |
|---|---------------------------------|--|---|---|------------------|--|
| WAAS<br>CH 99521<br>W30A  | APP CRS<br>301°                 | Rwy Idg<br>7415<br>TDZE<br>38<br>Apt Elev<br>60                          | <b>RNAV (GPS) Z RWY 30</b><br>LONG BEACH/DAUGHERTY FIELD (LGB)                      |   |                  |  |
| RNP APCH.   |                                 |  | MALSR   | MISSED APPROACH: Climb to 800 then climbing left turn to 3000 direct PADDR and hold |                  |  |
| <div style="border: 2px solid red; padding: 5px;">           ▼ For uncompensated Baro-VNAV systems, <u>LNAV/VNAV NA below 4°C or above 54°C.</u> For inop ALS, increase LNAV Cat C and D visibility to 1 3/8 SM.         </div> |                                 |  |  |   |                  |  |
| ATIS<br>127.75  | SOCAL APP CON<br>125.35 316.125 | LONG BEACH TOWER*<br>120.5 257.6 (Rwy 12)<br>119.4 (CTAF) 257.6 (Rwy 30) | GND CON<br>133.0 257.6  | CLNC DEL<br>118.15  | UNICOM<br>122.95 |  |

15.19.1. When the temperature is above the high temperature or below the low temperature limit, Baro-VNAV may be used to provide a stabilized descent to the LNAV MDA; however, extra caution should be used in the visual segment to ensure a vertical correction is not required. If the VGSI is aligned with the published glidepath, and the aircraft instruments indicate on glidepath, an above or below glidepath indication on the VGSI may indicate that temperature error is causing deviations to the glidepath. These deviations should be considered if the approach is continued below the MDA.

15.19.2. Many systems which apply Baro-VNAV temperature compensation only correct for cold temperature. In this case, the high temperature limitation still applies. Also, temperature compensation may require activation by maintenance personnel during installation in order to be functional, even though the system has the feature. Some systems may have a temperature correction capability, but correct the barometric altimeter all the time, rather than just on the final, which would create conflicts with other aircraft if the feature were activated. Pilots should be aware of compensation capabilities of the system prior to disregarding the temperature limitations.

**15.20. Approach Segments.** [FAA-H-8083-16, Chapter 4; ICAO Doc 8168 Volume 1] There are five segments to an instrument approach procedure: arrival, initial, intermediate, final, and missed approach (**Figure 15.10**). Approach segments begin and end at designated fixes; however,



there are circumstances where a segment begins at a point where no fixes are available. The intermediate segment begins at a point where the aircraft is proceeding inbound to the FAF along the final approach course within the “remain within” distance if an IF is not shown on an approach chart (Figure 15.11).

Figure 15.10. Approach Segments.

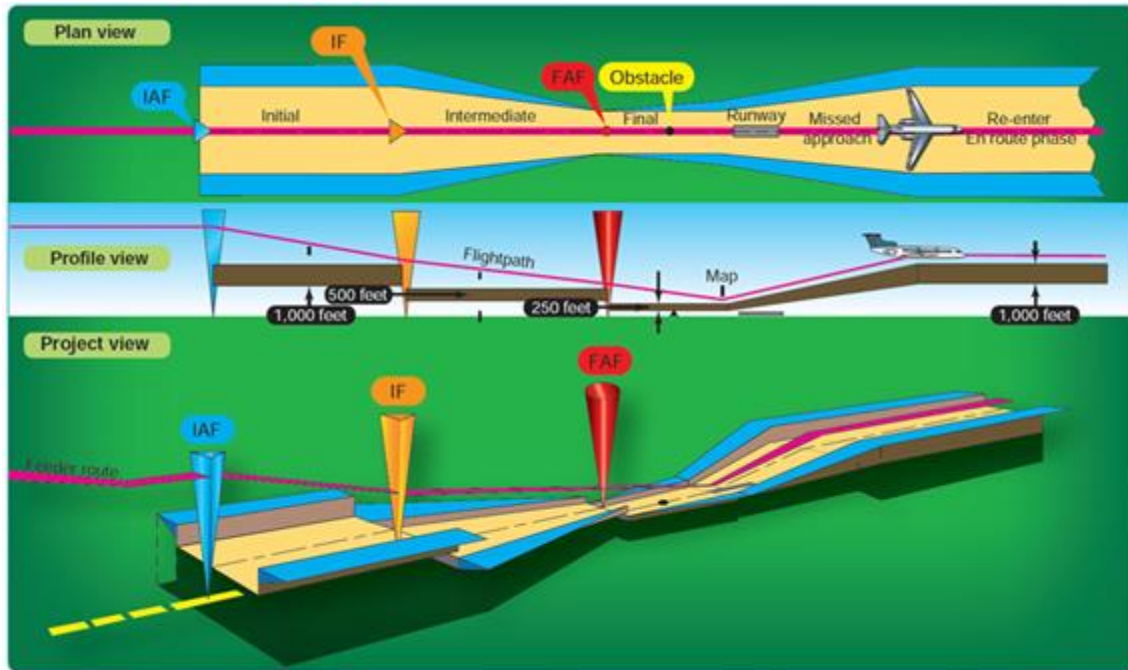
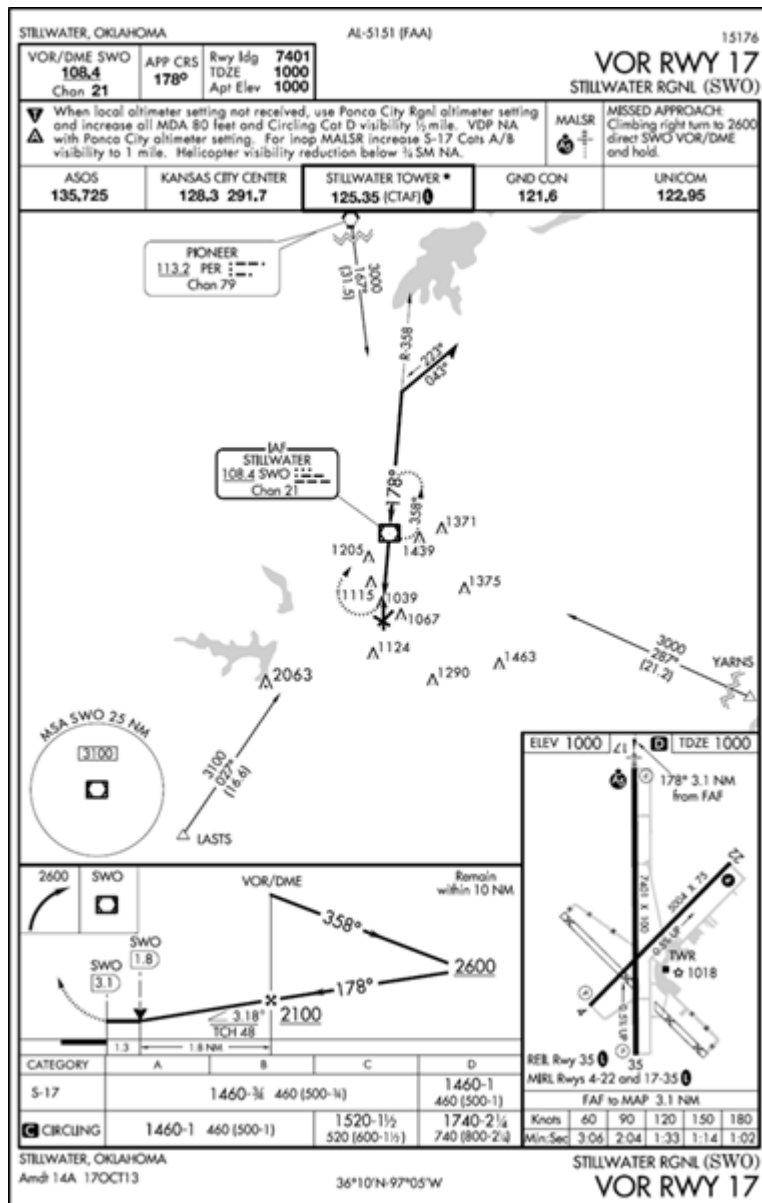


Figure 15.11. Instrument Procedure without a Charted IF.



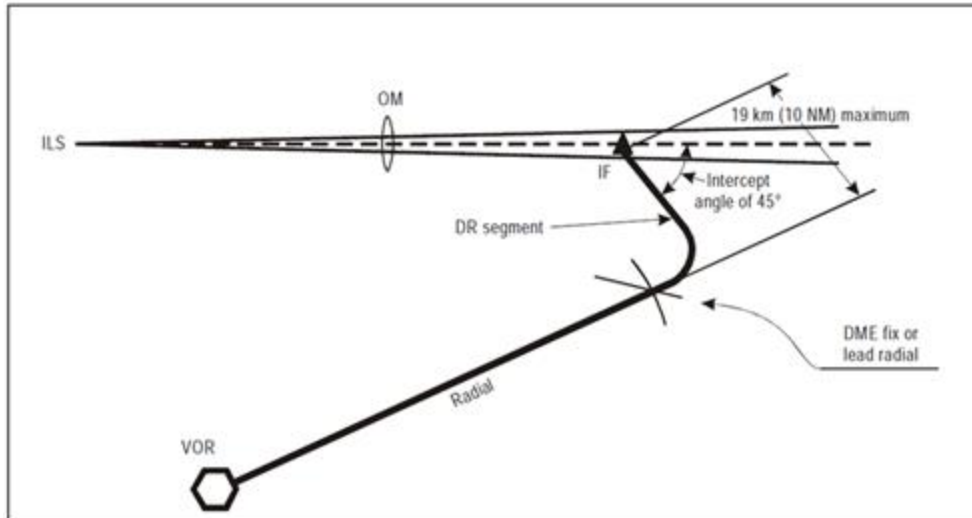
### 15.21. Dead Reckoning Segment. [ICAO Doc 8168 Volume 1 Section 4 Chapter 3.3]

15.21.1. An ILS procedure may include a dead reckoning segment from a fix to the localizer where an operational advantage can be obtained (Figure 15.12). The dead reckoning track intersects the localizer at 45 degrees and is not more than 10 nautical miles in length. The point of interception is the beginning of the intermediate segment and allows for proper glidepath interception.

15.21.2. [FAA Order 8260.3, Chapter 2] (NAS Only) An initial approach segment may include a dead reckoning course. The alignment of the dead reckoning course intercepts the extended intermediate course. For low altitude procedures, the intercept point is at least 1 nautical mile from the IF for each 2 nautical miles of dead reckoning flown. For high altitude procedures, the intercept point may be 1 nautical mile from the IF for each 3 nautical miles of

dead reckoning flown. The intercept angle does not exceed 90 degrees and is less than 45 degrees except when DME is used or the dead reckoning distance is 3 nautical miles or less.

**Figure 15.12. [ICAO] Dead Reckoning Segment.**



**15.22. Instrument Approach Segment Descents.** [ICAO Doc 8168 Volume 1] The aircraft will cross the fix or facility and fly outbound on a specific track, descending, as necessary, to the procedure altitude but no lower than the minimum crossing altitude associated with that segment of the approach. **(T-0)**. If further descent is specified after the inbound turn, this descent will not be started until the aircraft is established on the inbound track in accordance with [paragraph 15.23. \(T-0\)](#).

**15.23. Established on Track.** [ICAO Doc 8168 Volume 1] The aircraft is not “established on track” until within the following limits:

- 15.23.1. Within half-full-scale deflection;
- 15.23.2. Within +/-5 degrees of the required bearing for NDB;
- 15.23.3. **[NAS Only]** Within full-scale deflection for LOC; or
- 15.23.4. Within 1X the required accuracy for RNAV or RNP segments flown [AIM 5-5-16];

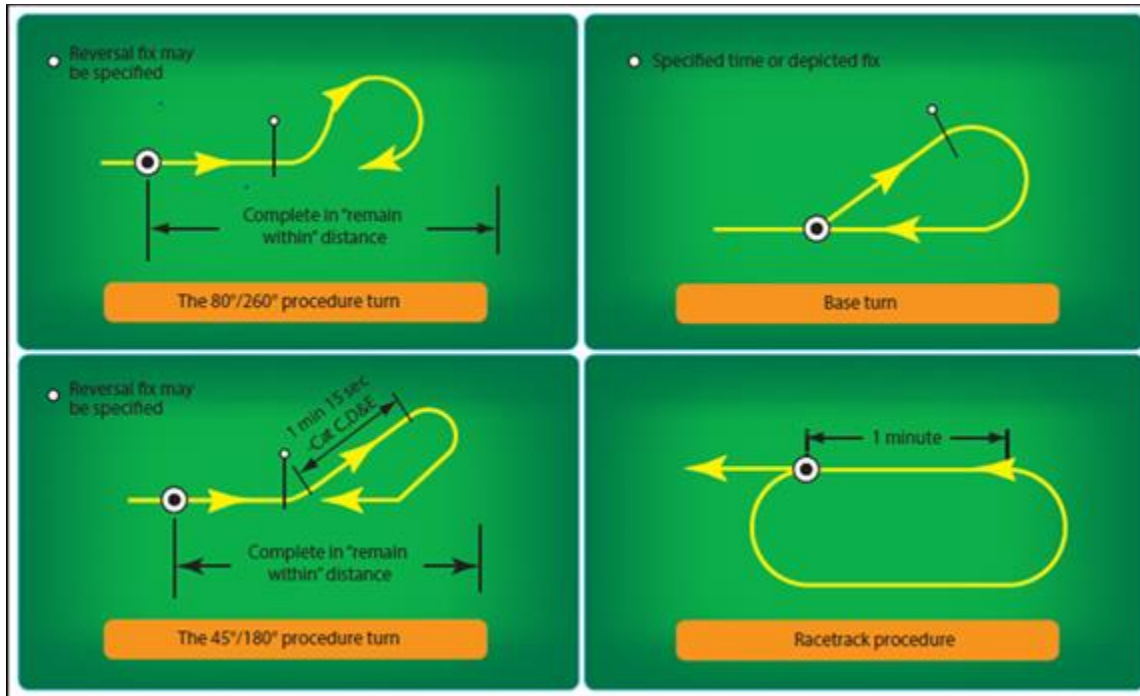
**15.24. Shuttle, Climb-in Hold, and Descent-in Hold.** [ICAO Doc 8168 Volume 1, Chapter 3.3.8]

15.24.1. **[ICAO]** A shuttle is a descent or climb conducted in a holding pattern. A shuttle is normally specified where the descent required between the end of the initial approach and the beginning of the final approach exceeds standard ICAO approach design limits.

15.24.2. **[NAS Only]** When a climb-in hold is specified by a published procedure (e.g., “climb-in holding pattern to depart XYZ VORTAC at or above 10,000”), additional obstacle protection area has been provided to allow for greater airspeeds in the climb for those aircraft requiring them. A maximum airspeed of 310 KIAS is permitted in climb-in holding, unless a maximum holding airspeed is published.

**15.25. Types of Course Reversals.** The two types of course reversal procedures are the procedure turn and the racetrack or (NAS Only) HILPT. Procedure turns include the 45°/180°, 80°/260°, and base turn or (NAS Only) teardrop ([Figure 15.13](#)).

**Figure 15.13. Types of Course Reversals.**



**15.26. ICAO-Specific Course Reversal and Racetrack Procedures.** [ICAO Doc 8168 Volume 1, Section 4, Chapter 3] Unless the procedure specifies entry restrictions, reversal procedures must be entered from a track within +/-30 degrees of the outbound track ([Figure 15.14](#)). (T-0). However, for base turns, where the +/-30-degree direct sector does not include the reciprocal of the inbound track, the entry sector is expanded to include the additional area ([Figure 15.15](#)).

15.26.1. ICAO specifies a 30-degree sector entry because the course reversal protected airspace may not include any airspace except on the outbound side of the procedure turn fix. In the NAS, protected airspace includes a much larger entry zone surrounding the fix ([Figure 15.16](#)). If the aircraft arrival track is not within the entry sector most course reversals have a published arrival holding pattern at or near the IAF to accommodate arrivals from outside the entry sector. PANS-OPS directs pilots coming from outside the entry sector to enter holding prior to commencing the reversal procedure. In most cases the holding pattern aligns the aircraft with the entry sector for the instrument procedure.

15.26.2. Bank angle is based on the average achieved bank angle of 25 degrees, or the bank angle giving a rate of 3 degrees per second (standard rate), whichever is less.

Figure 15.14. Direct Entry Sector.

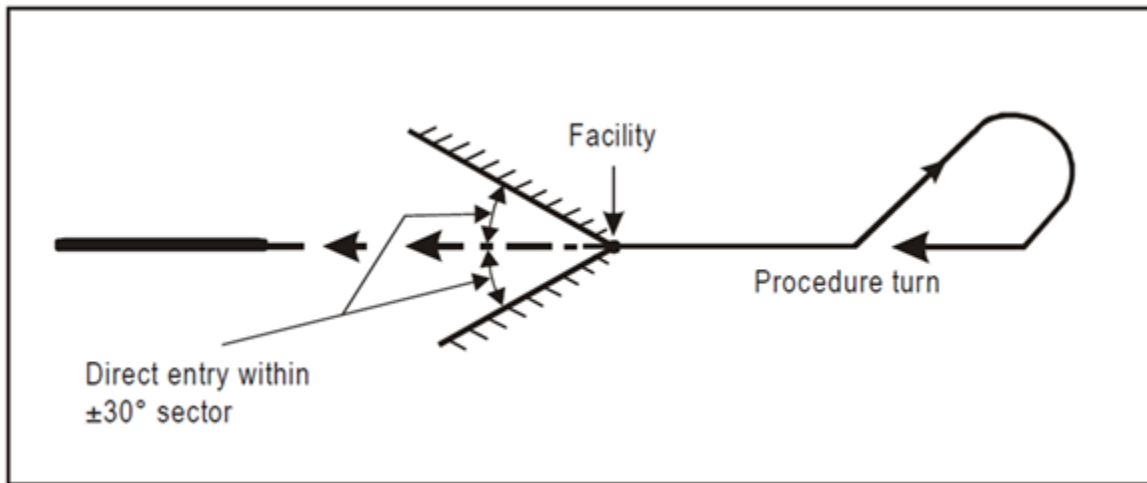


Figure 15.15. Base Turn Entry Expanded Entry Sector.

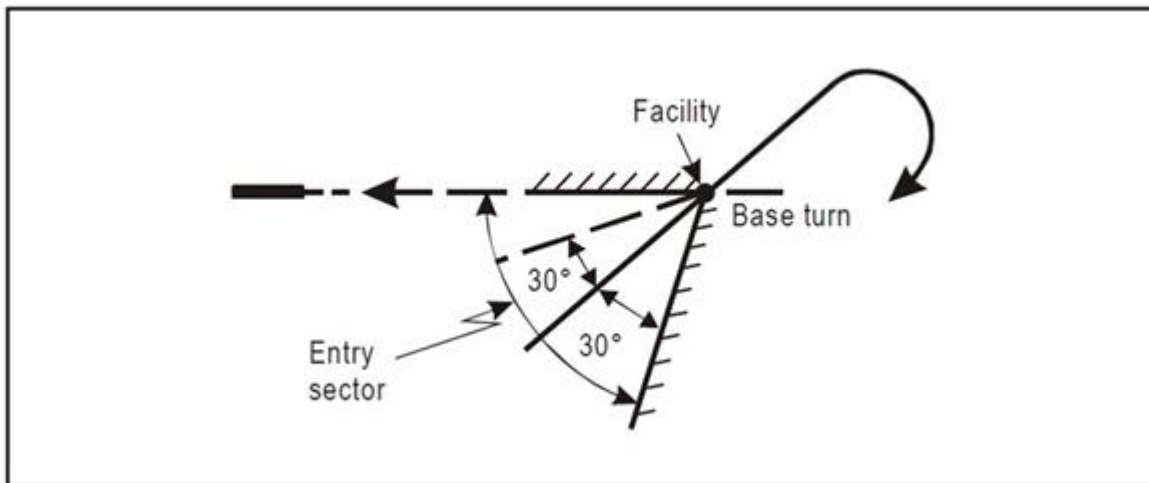
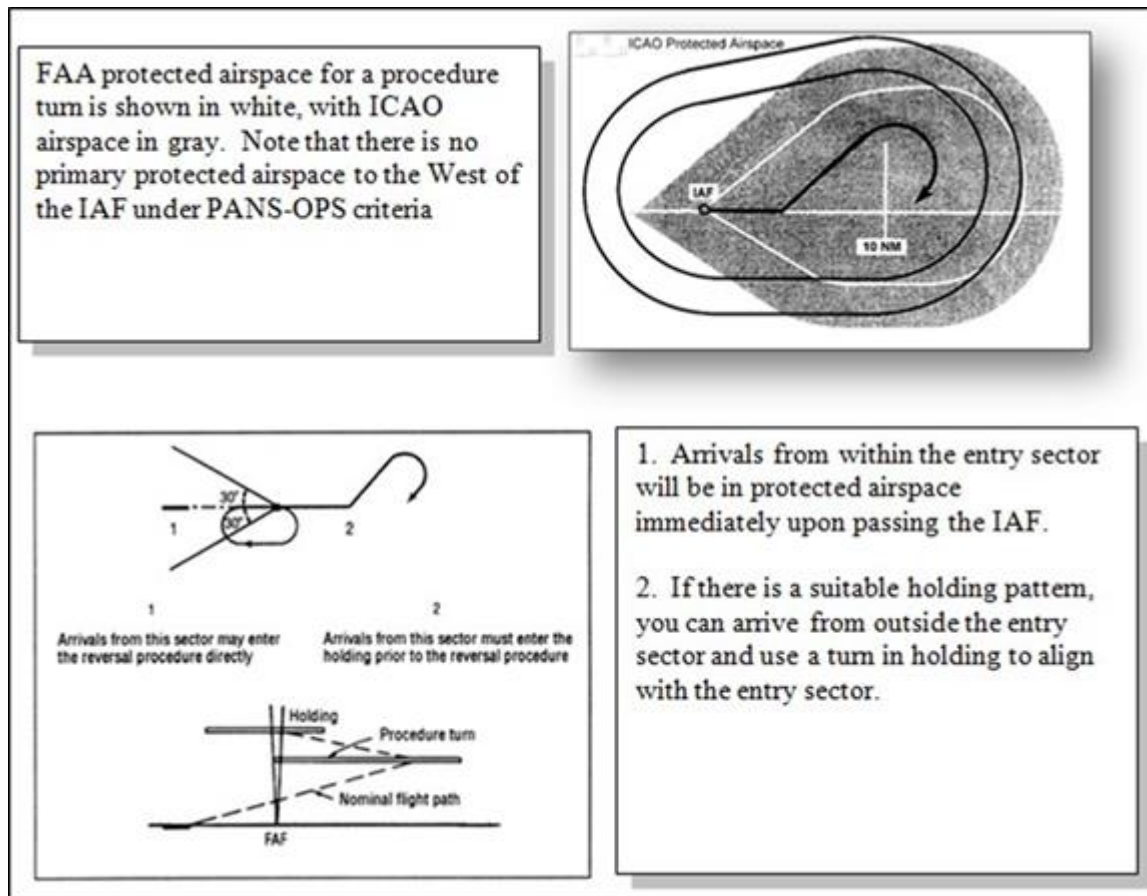


Figure 15.16. ICAO PANS-OPS versus U S TERPS Protected Airspace.



15.26.3. Descent rates are in accordance with [Table 15.3](#)

Table 15.3. ICAO Course Reversal and Racetrack Descent Rates.

| Outbound Track   | Maximum Descent Rate* | Minimum Descent Rate* |
|------------------|-----------------------|-----------------------|
| Category A/B     | 804 feet/min          | N/A                   |
| Category C/D/E/H | 1197 feet/min         | N/A                   |
| Inbound Track    |                       |                       |
| Category A/B     | 655 feet/min          | 394 feet/min          |
| Category C/D/E   | 1000 feet/min         | 590 feet/min          |
| Category H       | 755 feet/min          | N/A                   |

\* Maximum or Minimum descent for 1 minute nominal outbound time in feet

15.26.4. Apply drift corrections to track the published ground track. All ICAO instrument procedures must be flown as depicted. **(T-0)**. The 45°/180° procedure turn is an alternative to the 80°/260° procedure turn and vice versa, unless specifically excluded on the procedure.

15.26.5. Allowances should be made in both heading and timing to compensate for the effects of wind so that the aircraft regains the inbound track as accurately and expeditiously as possible. In making these corrections, full use should be made of the indications available from the NAVAID and from estimated and known winds. This is particularly important for slow aircraft in high wind conditions, when failure to compensate may render the procedure

unflyable (i.e., the aircraft may pass the fix before establishing on the inbound track or it could depart the protected airspace).

15.26.6. Before crossing the IAF, reduce airspeed to aircraft flight manual required speeds, the maximum category speed in accordance with **Table 15.4**, or the maximum speed published on the procedure, whichever is lowest.

**Table 15.4. ICAO Maximum Speeds for Course Reversals and Racetrack Procedures.**

| Category | Initial Approach Speed Range (KIAS) | Final Approach Speed Range (KIAS) |
|----------|-------------------------------------|-----------------------------------|
| A        | 90 to 150 (110*)                    | 70 to 100                         |
| B        | 120 to 180 (140*)                   | 85 to 130                         |
| C        | 160 to 240                          | 115 to 160                        |
| D        | 185 to 250                          | 130 to 185                        |
| E        | 185 to 250                          | 155 to 230                        |
| H        | 70 to 120**                         | 60 to 90***                       |

**Note:** The speeds given are converted and rounded to the nearest multiple of five for operational reasons and from the standpoint of operational safety are considered equivalent.

\* Maximum speed for reversal and racetrack procedures.

\*\* Maximum speed for reversal and racetrack procedure up to including 6,000 feet is 100 knots and 110 KIAS above 6,000 feet.

\*\*\* Helicopter point-in-space procedures based on basic GNSS may be designed using maximum speeds of 120 knots for initial and intermediate segments and 90 knots on final, or 90 knots for initial and intermediate segments and 70 knots on final depending on the operational need. Refer to PANS-OPS, Vol II, Part IV, Chapter 2, PinS RNP APCH approach procedures for helicopter down to LNAV minima.

**15.27. Procedure Turn.** [AIM 5-4-9] Procedure turns are depicted in the plan view on U.S. Government instrument procedure charts with a “barb” arrow indicating the maneuvering side of the outbound course on which the procedure turn is to be accomplished (**Figure 15.17**). A procedure turn is NA when there is no barb depicted (**Figure 15.18**).



Figure 15.17. Procedure Turn.

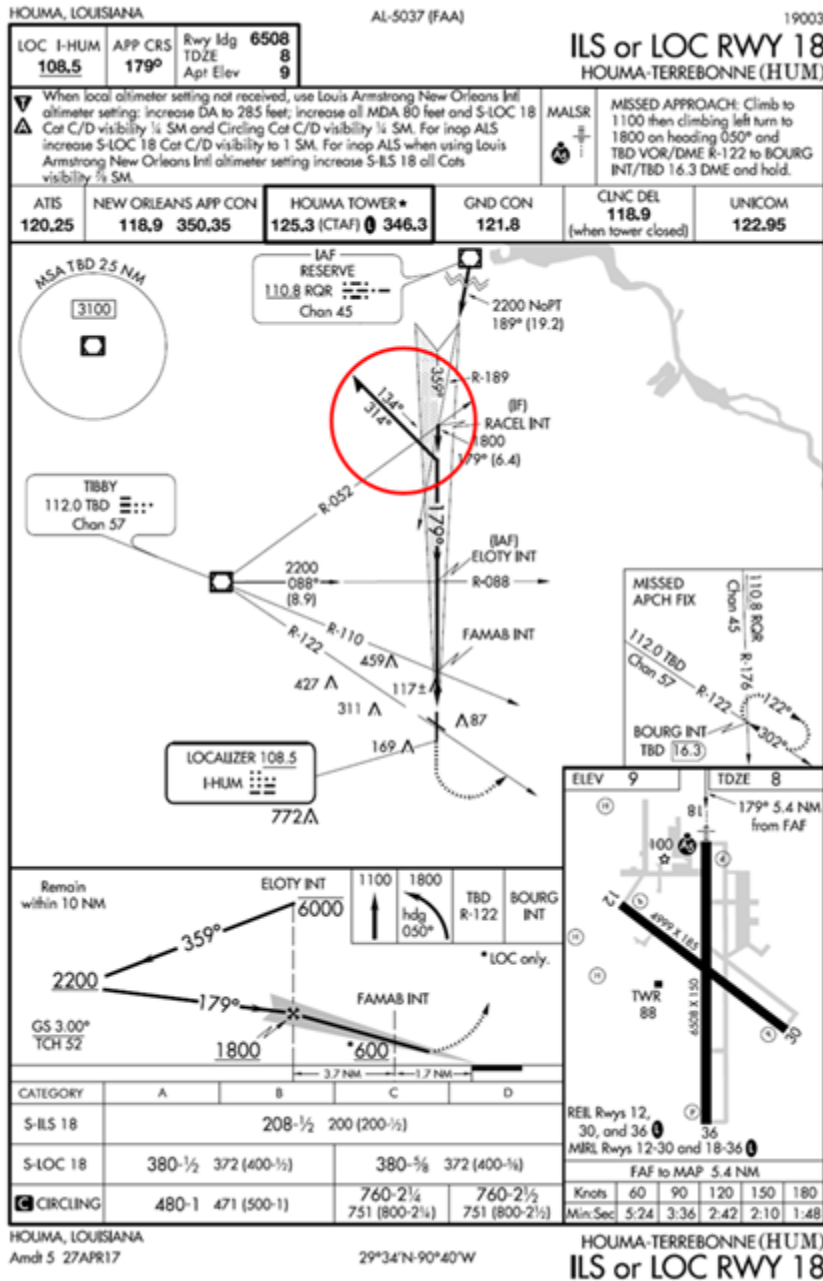
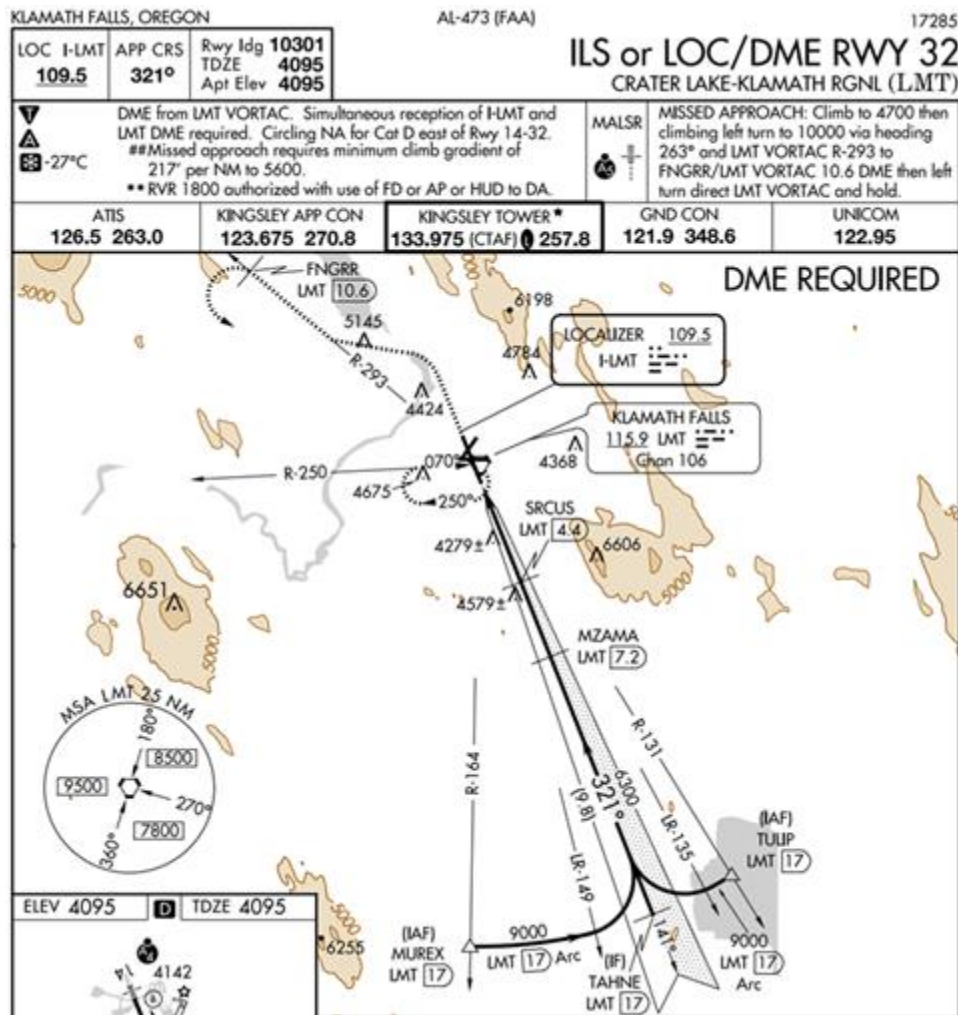


Figure 15.18. Procedure Turn Not Authorized.



15.27.1. [NAS Only] Headings are provided for course reversals using the 45°/180° procedure turn; however, the point at which the turn may be commenced, the type and the rate of turn is at the pilot's discretion limited by the charted "remain within distance." Some examples options are the 45°/180°, 80°/260°, the racetrack pattern, or the teardrop procedure turn.

15.27.2. Procedure turns should be flown at airspeeds of 200 KIAS or less to ensure containment within the obstruction clearance area provided by the design criteria.

15.27.3. Plan the outbound leg to allow enough time for configuration and any descent required prior to the FAF. Adjust the outbound leg length to ensure the aircraft will stay inside the "remain within distance" noted on the profile view of the instrument procedure. (T-0). The "remain within distance" is measured from the procedure turn fix unless the instrument procedure specifies otherwise. Turn to intercept the inbound course at the completion of the outbound leg. The normal remain within distance is 10 miles; it may be reduced to 5 miles where only CAT A and helicopters operate or increased to 15 miles to accommodate high performance aircraft.

15.27.3.1. When the NAVAID is on the field and no FAF is depicted, plan the outbound leg so the descent to MDA can be completed with sufficient time to acquire the runway and position the aircraft for a normal landing (**Figure 15.19**).

15.27.3.2. When flying this type of approach, the FAF is the point when the pilot begins descending from the procedure turn completion altitude. Since this point is considered the FAF, the pilot should establish approach configuration and airspeed prior to departing procedure turn completion altitude unless aircraft flight manual procedures require otherwise.

15.27.4. Do not descend from the procedure turn fix altitude (published or assigned) until crossing over or outbound abeam the procedure turn fix. Do not descend from the procedure turn completion altitude until established on the inbound segment of the approach. Procedures may contain a note on the chart profile or depict an “at or above” altitude at the procedure turn fix without a note (**Figure 15.20**). Absence of a chart note or a specified minimum altitude adjacent to the procedure turn fix is an indication that descent to the procedure turn altitude can commence immediately upon crossing over the procedure turn fix, regardless of the direction of flight.

Figure 15.19. Procedure Turn with No FAF Depicted.

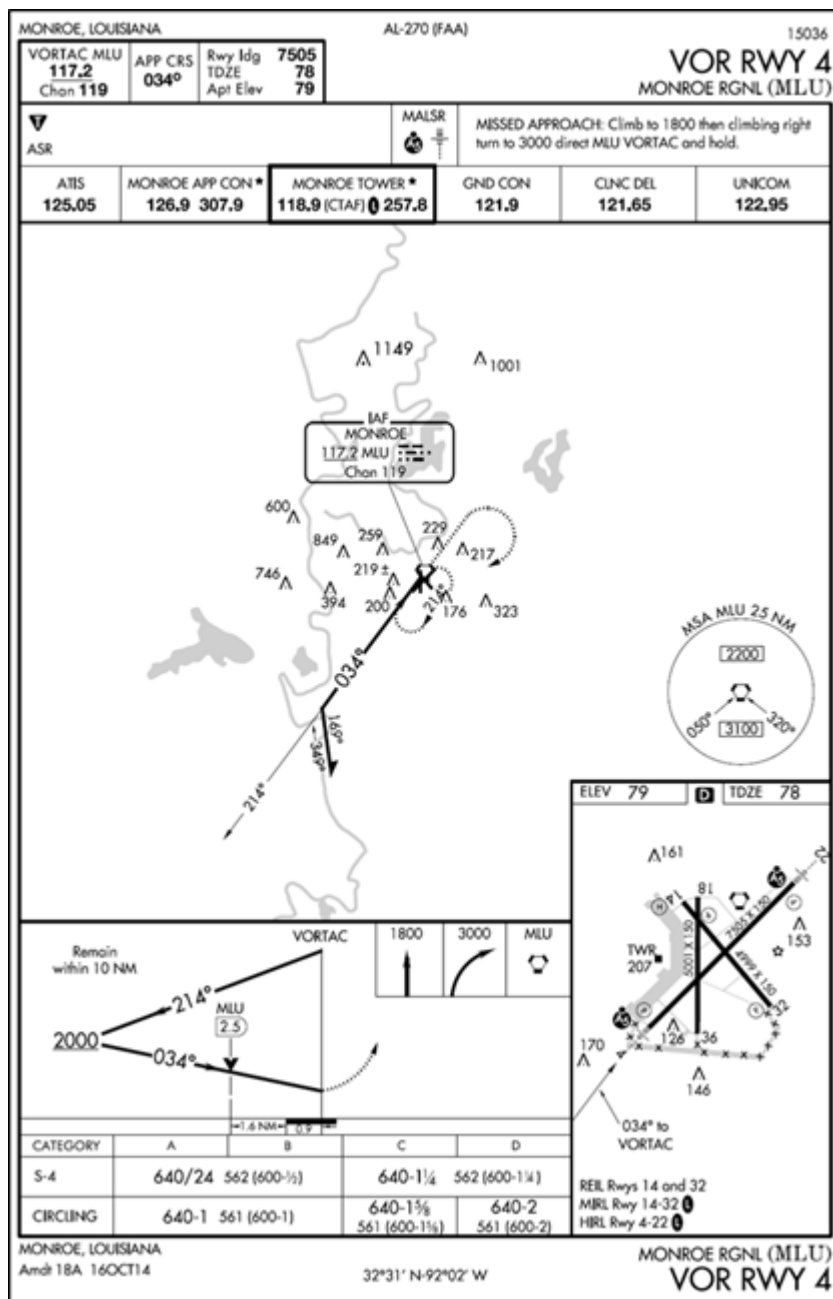
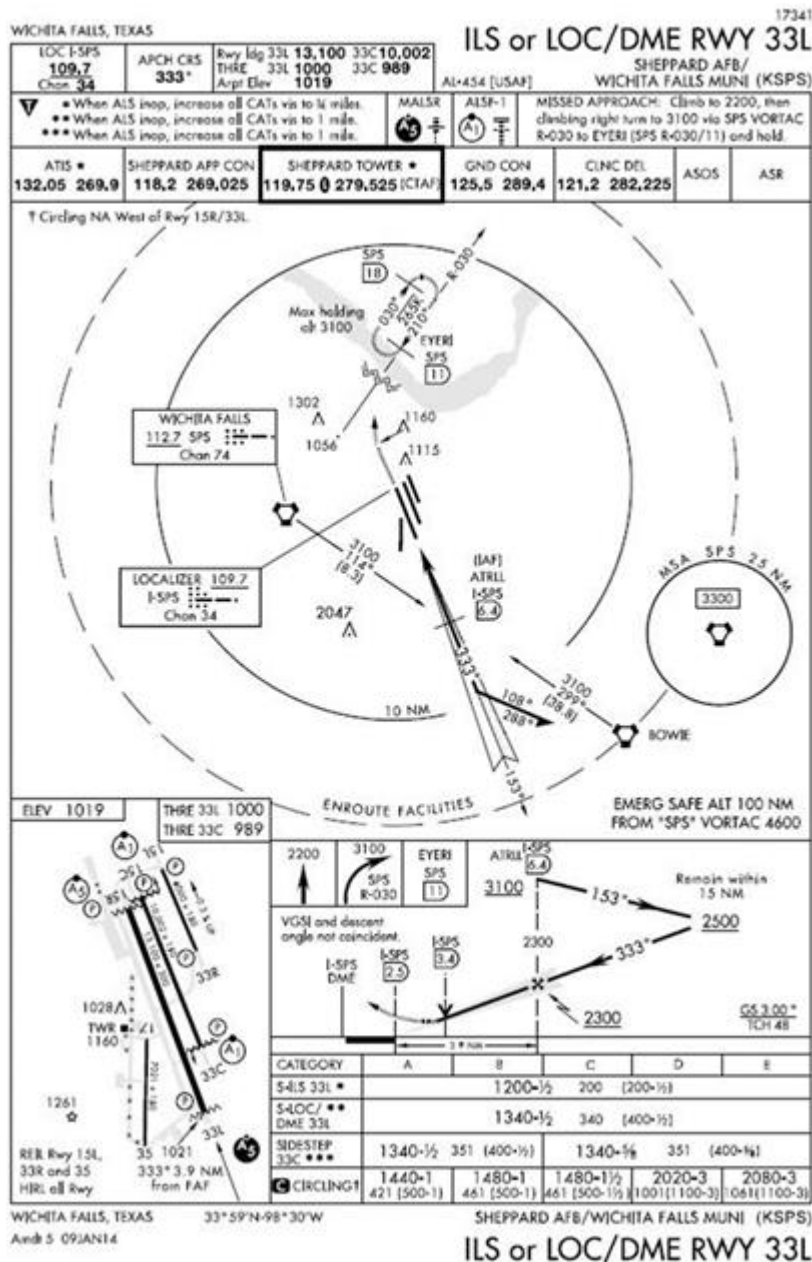


Figure 15.20. Procedure Turn Fix Altitude.



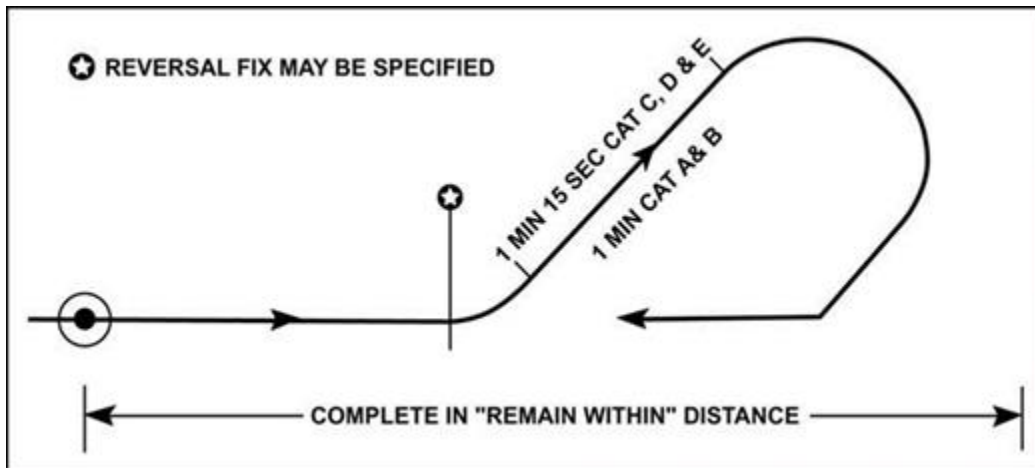
15.28. Procedure Turn - 45°/180°. The 45°/180° starts at a facility or fix IAF and consists of the following (Figure 15.21):

- 15.28.1. A straight outbound leg with course guidance limited by time, radial or distance;
- 15.28.2. A 45 degree turn commenced at the designated radial or DME fix, or at the completion of the published timing requirement;
- 15.28.3. A timed straight leg without track guidance. Begin timing upon initiating the 45 degree turn. Time for 1 minute (Categories A and B) or 1 minute and 15 seconds (Categories C, D, and E); timing is mandatory under ICAO. (T-0). **Note:** Adjust the time or distance on the outbound track to ensure the reversal is initiated at a point specified on the instrument

procedure if so depicted, or the maneuver is completed within the specified “remain within” distance.

15.28.4. The 180-degree turn is made in the opposite direction of the 45-degree turn to intercept the inbound track.

**Figure 15.21. 45°/180° Procedure Turn.**



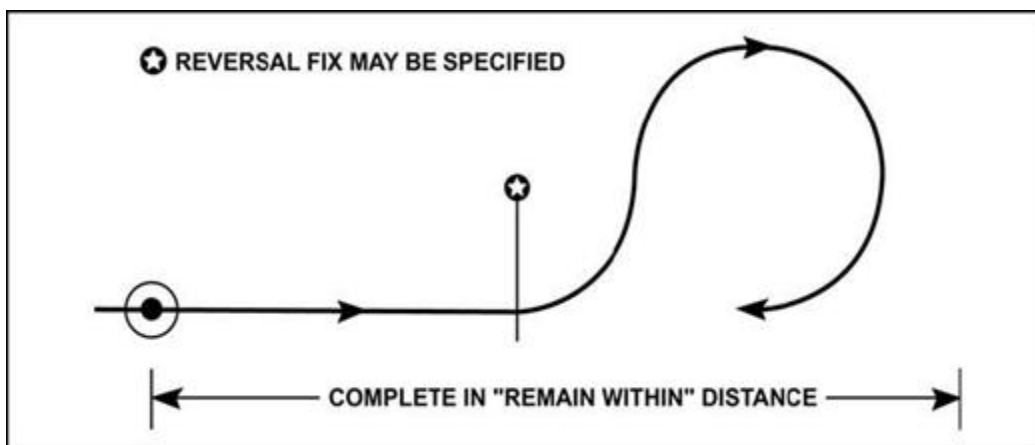
**15.29. Procedure Turn – 80°/260°.** The 80°/260° starts at a facility, fix, or IAF and consists of the following ([Figure 15.22](#)):

15.29.1. A straight outbound leg with course guidance limited by time, radial or distance; **Note:** Adjust the time or distance on the outbound course to ensure the reversal is initiated at a point specified on the instrument procedure if depicted, or the maneuver is completed within the specified “remain within” distance.

15.29.2. An 80 degree turn commenced at the designated radial or DME fix, or at the completion of the published timing requirement, followed immediately by;

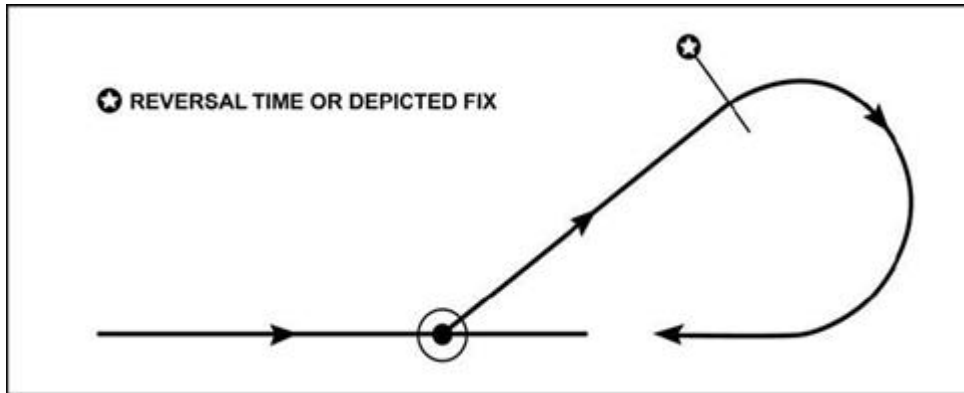
15.29.3. A 260 degree turn in the opposite direction to intercept the inbound track.

**Figure 15.22. 80°/260° Procedure Turn.**



**15.30. Base Turn or (NAS Only) Teardrop.** [ICAO Doc 8168 Volume 1, Section 4, Chapter 3; AIM 5-4-9] This procedure consists of intercepting and maintaining a specified outbound track, timing or DME distance from a facility or fix, followed by a turn to intercept the inbound track ([Figure 15.23](#)).

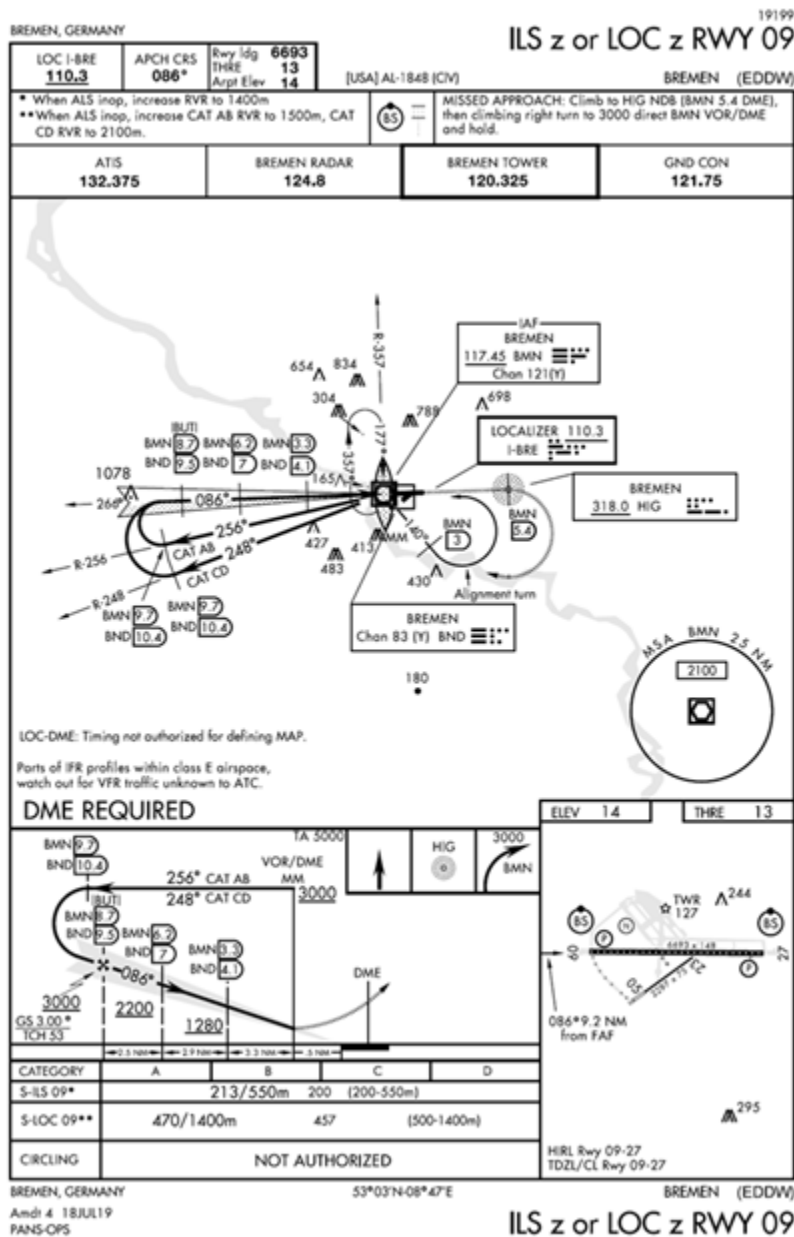
**Figure 15.23. Base Turn or (NAS Only) Teardrop.**



15.30.1. The base turn must be flown as depicted. (T-0). More than one track may be depicted depending on aircraft category ([Figure 15.24](#)).



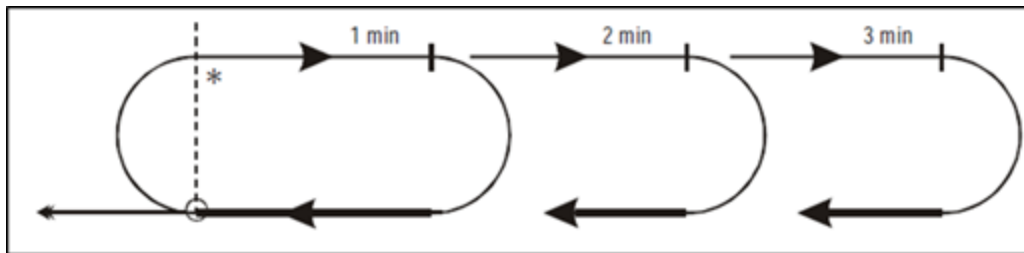
Figure 15.24. Base Turn with More Than One Track.



**15.31. Racetrack or (NAS Only) HILPT.** [ICAO Doc 8168 Volume 1, Section 4, Chapter 3; AIM 5-4-9] This procedure consists of a turn from the inbound track through 180 degrees from overhead the facility or fix on to the outbound track for 1, 2, or 3 minutes specified in 30-second increments, followed by a 180 degree turn in the same direction to return to the inbound track (Figure 15.25 and Figure 15.26). As an alternative to timing, a DME distance or an intersecting radial or bearing may limit the outbound leg. Racetrack procedures are used when sufficient distance is not available in a straight segment to accommodate the required loss of altitude and when entry into a reversal procedure is not practical. They may also be specified as alternatives to reversal procedures to increase operational flexibility (in this case, they are not necessarily published separately).

15.31.1. [NAS Only] The HILPT is depicted as a holding pattern printed with a heavy black line in the plan view and established over an IF or FAF.

**Figure 15.25. Racetrack or (NAS Only) HILPT.**



15.31.2. Entry procedures are in accordance with the holding entry procedures from [Chapter 13](#) with the following considerations:

15.31.2.1. Pilots will limit time on a 30-degree teardrop track to 1 minute and 30 seconds, then turn to a heading parallel to the outbound track for the remainder of the outbound time for an offset entry; pilots will limit time on a 30-degree teardrop track to 1 minute if the outbound time is only 1 minute. **(T-0)**.

15.31.2.2. Pilots will not turn direct to the facility without first intercepting the inbound track for a parallel entry. **(T-0)**.

15.31.2.3. Pilots will maneuver on the maneuvering side of the inbound track. **(T-0)**.

15.31.3. Timing:

15.31.3.1. When the procedure is based on a facility, the outbound timing starts from abeam the facility or on attaining the outbound heading, whichever occurs last.

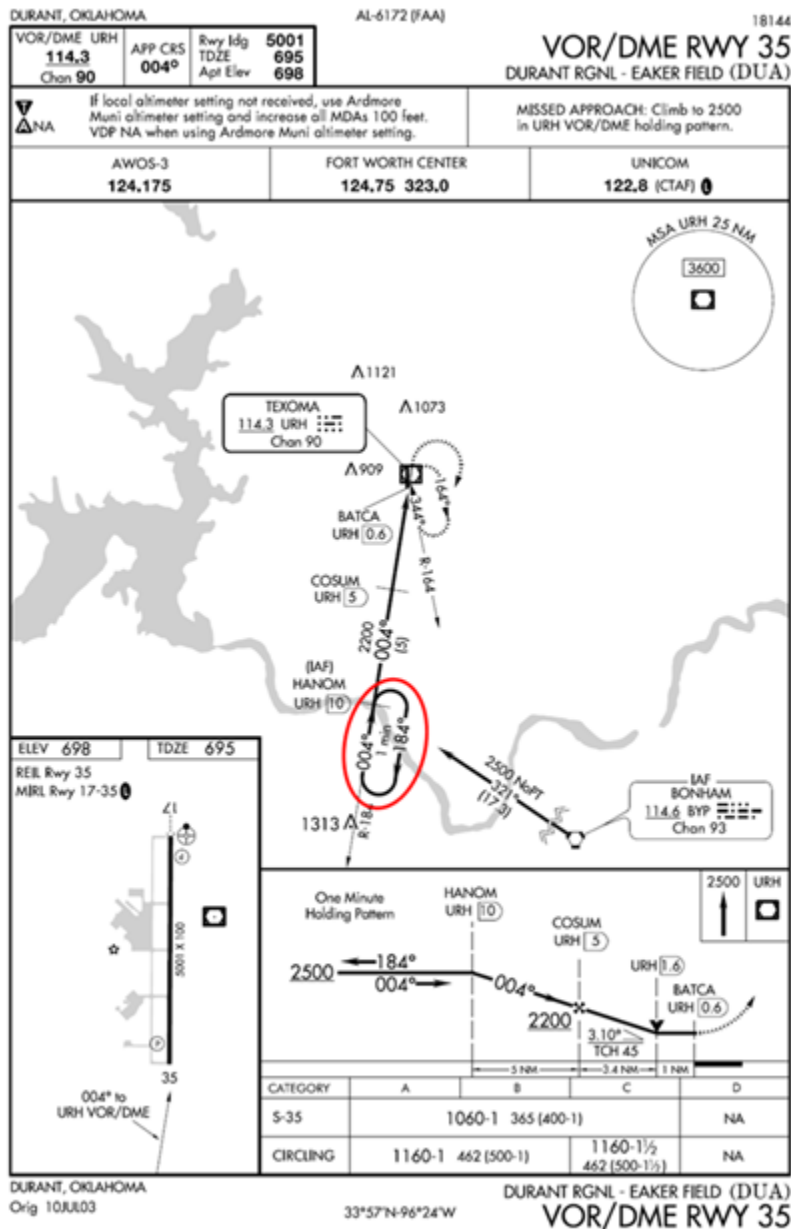
15.31.3.2. When the procedure is based on a fix, the outbound timing starts from attaining the outbound heading.

15.31.3.3. The turn onto the inbound track should be started within the specified time adjusted for winds, when encountering the published DME distance, or when the limiting radial or bearing has been reached, whichever occurs first.

15.31.3.4. Descent from the minimum holding altitude may be depicted in two ways: descent at the holding fix or descent on the inbound leg. The pilot must be established on the inbound segment of the approach before beginning descent when a descent is depicted on the inbound leg. **(T-0)**.

15.31.3.5. [AIM 5-4-9] If cleared for the approach prior to returning to the holding fix and the aircraft is at the prescribed altitude, additional circuits of the holding pattern are not necessary nor expected by ATC. If pilots elect to make additional circuits to lose excessive altitude or to become better established on track, it is their responsibility to advise ATC upon receipt of their approach clearance.

Figure 15.26. HILPT Approach.

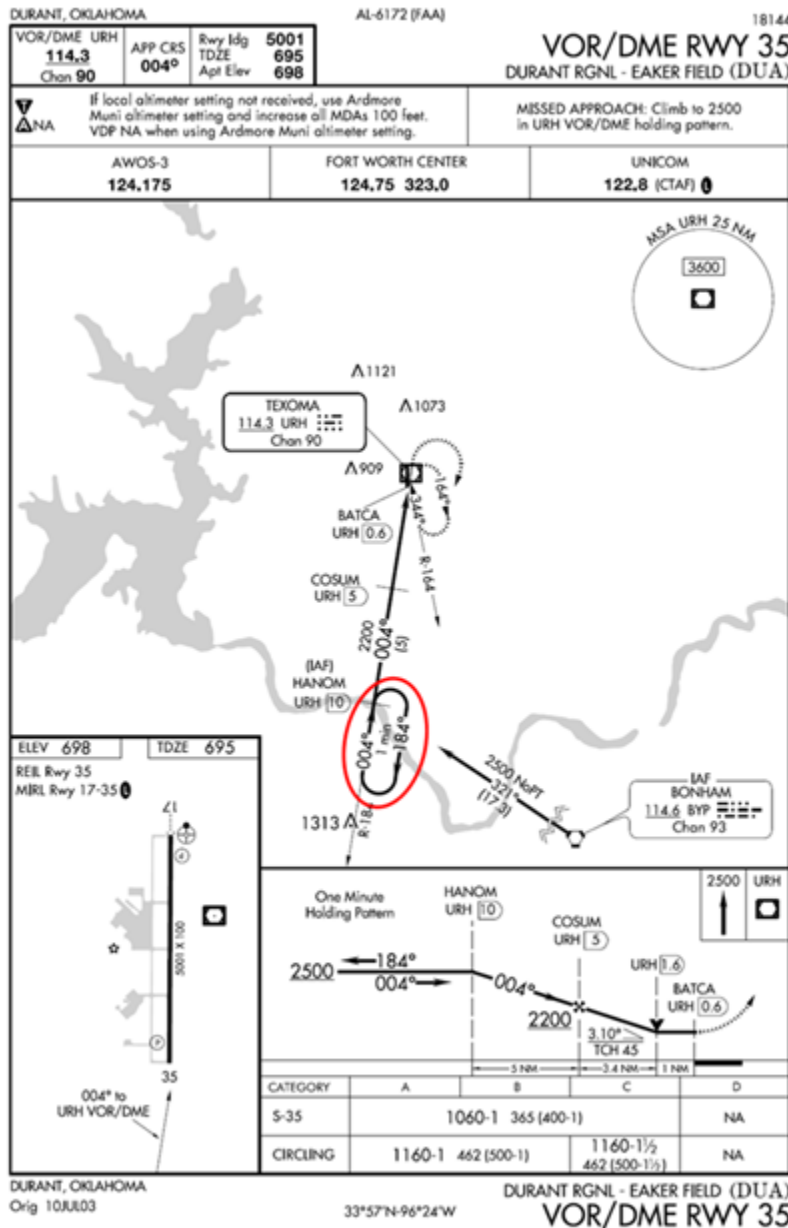


**15.32. Limitations on Procedure Turns (NAS Only).** [14 CFR Part 91.175(j)] Pilots will not execute a course reversal when:

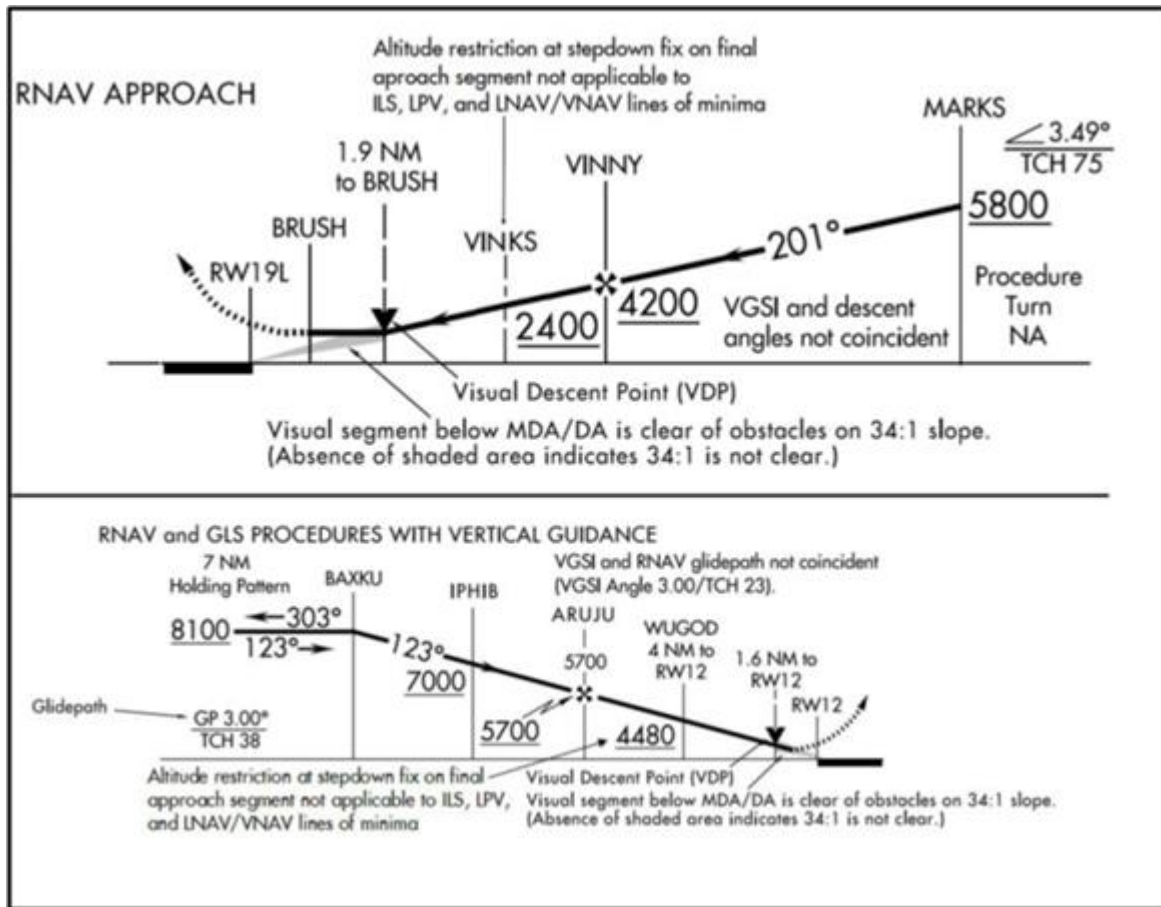
- 15.32.1. Cleared for a straight-in approach; **(T-0)**.
- 15.32.2. The symbol “NoPT” is depicted on the initial approach segment of the approach **(Figure 15.27)**; **(T-0)**.
- 15.32.3. Established on the inbound course after executing the appropriate entry and subsequently cleared for the approach; **(T-0)**.
- 15.32.4. A radar vector to the final approach course is provided; or **(T-0)**.

15.32.5. Conducting a timed approach from a holding fix [AIM 5-4-10]. (T-0).

Figure 15.27. [NAS Only] NoPT Routing.



**15.33. Stepdown Fixes.** [AIM 5-4-5] Altitude restrictions depicted at stepdown fixes within the final approach segment are applicable only when flying a non-precision approach to a straight-in or circling line of minima identified as a MDA (Figure 15.28). Stepdown fix altitude restrictions within the final approach segment do not apply to pilots using precision approach or approach with vertical guidance lines of minima identified as a DA or DH, since obstacle clearance on these approaches are based on the aircraft following the applicable vertical guidance. Pilots are responsible for adherence to stepdown fix altitude restrictions when outside the final approach segment regardless of which type of procedure the pilot is flying. (T-0).

**Figure 15.28. Instrument Procedure Stepdown Fixes.**

**15.34. High Altitude Approaches.** Establish approach configuration and airspeed prior to the FAF unless aircraft flight manual procedures require otherwise.

**15.35. Non-DME Teardrop High Altitude Approach.** Non-DME teardrop high altitude approaches are normally associated with VOR or NDB facilities ([Figure 15.29](#)).

15.35.1. When station passage occurs at the IAF, turn immediately in the shorter direction toward the outbound course and attempt to intercept it. Begin descent when established on a parallel or intercept heading to the approach course and outbound from IAF. Use a descent gradient of 800-1,000 feet per nautical mile (8 degrees to 10 degrees) to ensure the aircraft remains in protected airspace.

15.35.1.1. If arriving at the IAF below the published altitude, the pilot should maintain altitude and proceed outbound 15 seconds for each 1,000 feet the aircraft is below the published altitude before starting descent.

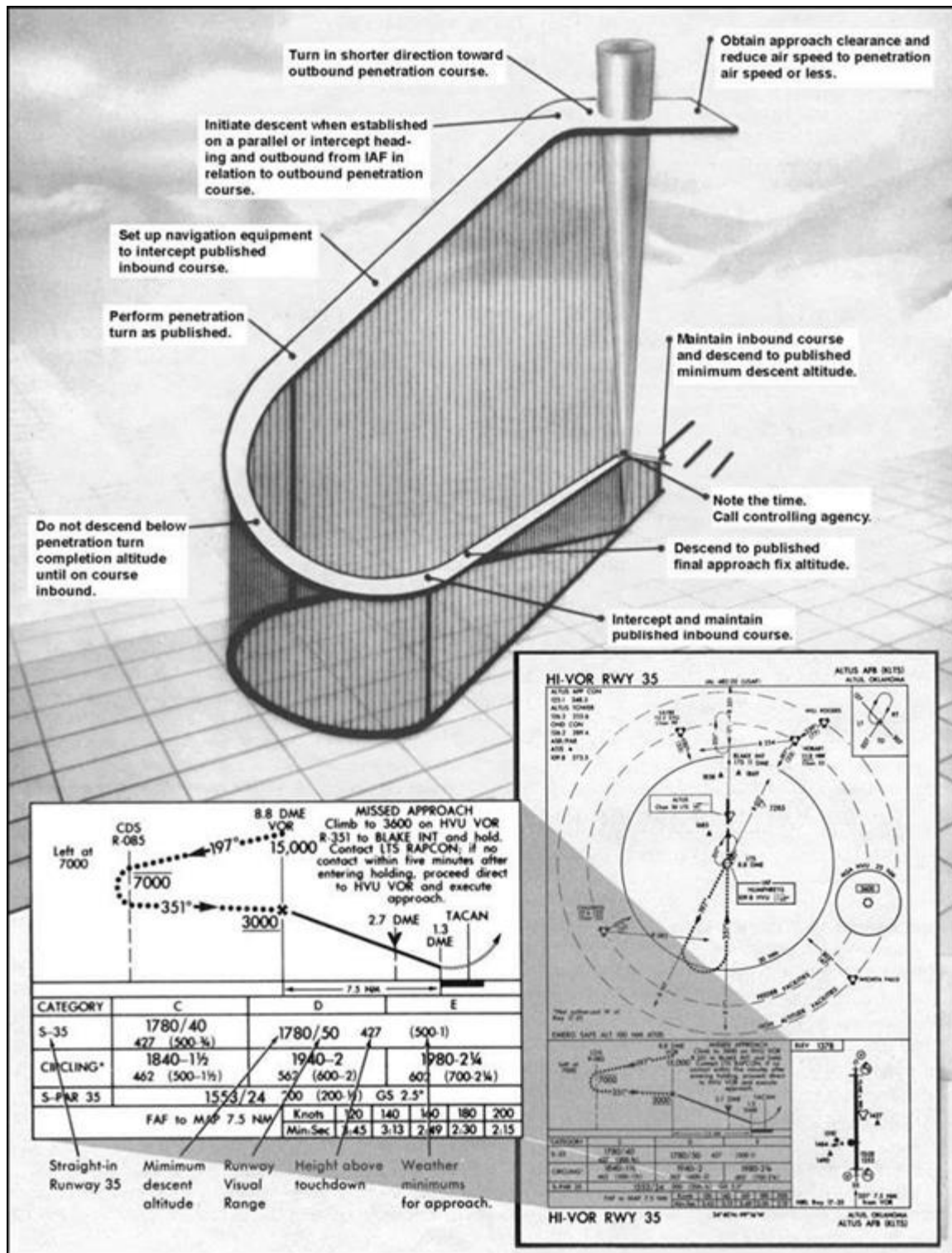
15.35.1.2. If arriving at the IAF above the published altitude, the pilot should descend to the published IAF altitude prior to starting the approach. Request maneuvering airspace from ATC if descent is required at the IAF.

15.35.2. A 30-degree angle of bank is normally used during the penetration turn; however, bank may be shallowed if undershooting course.

15.35.2.1. When a penetration turn altitude is not published, start the turn after descending one half the total altitude between the IAF and FAF altitudes.

15.35.2.2. If a penetration turn completion altitude is published, do not descend below this altitude until established on the inbound course.

Figure 15.29. Non-DME Teardrop High Altitude Approach.



15.36. Helicopter-Only Approaches. Helicopter only approaches are identified by the term “COPTER”, the type of facility producing final approach course guidance, and a numerical

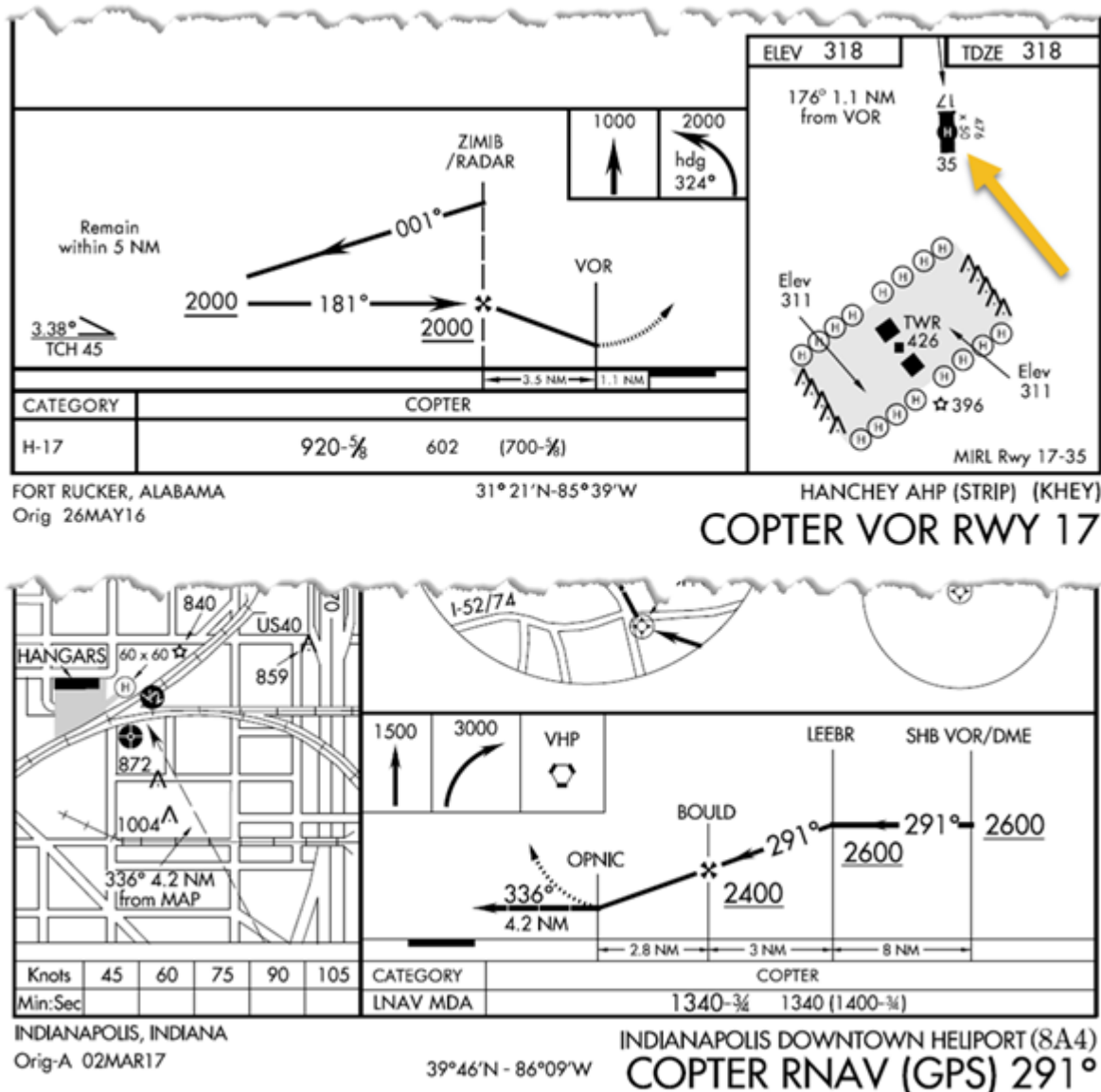


identification of the final approach course; for example, “COPTER VOR RWY 17” or “COPTER RNAV (GPS) 291°” (Figure 15.30).

15.36.1. These approaches are considered “straight-in” approaches. The pilot should plan to touch down on the threshold of the procedure runway or helipad. The designated instrument helipad is shown with inverse symbology if there are multiple helipads (Figure 15.30).

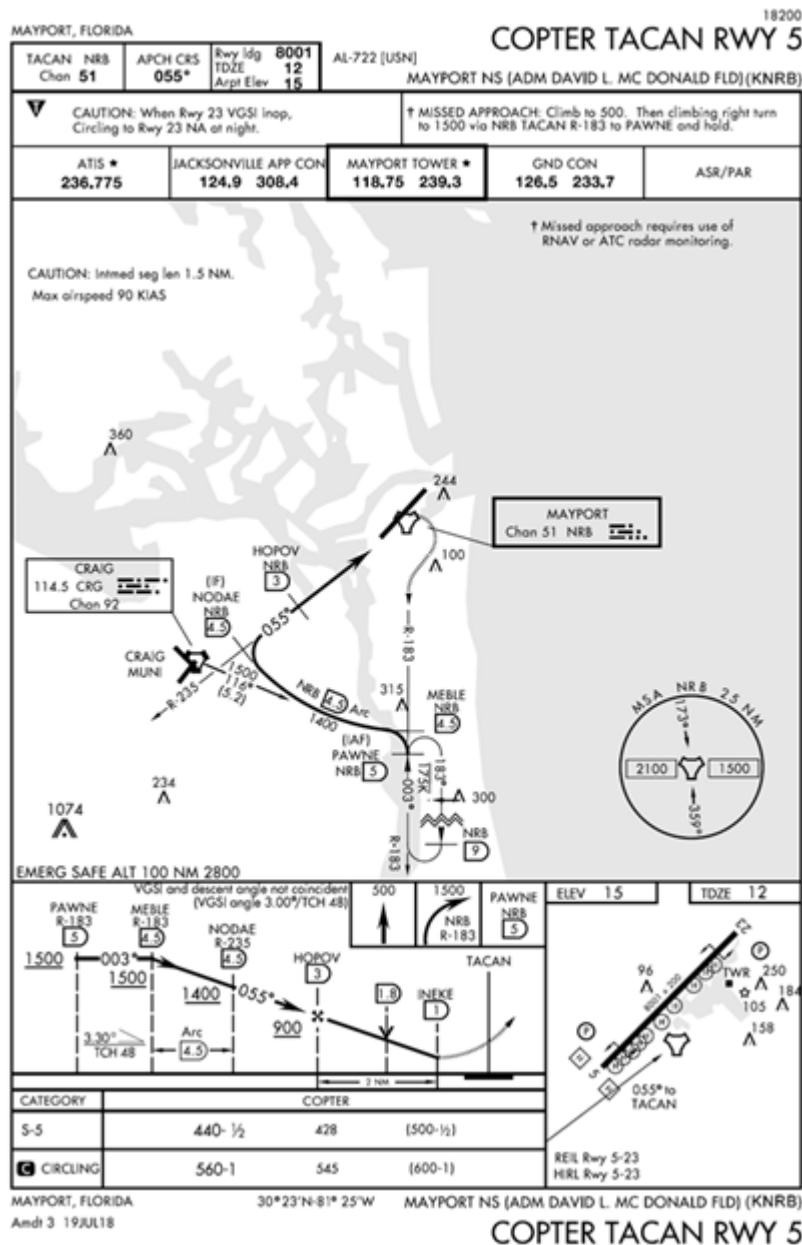
15.36.2. A maximum descent of 400 feet per nautical mile is normally planned for low altitude approaches; it may be as high as 800 feet per nautical mile for helicopter only approaches.

Figure 15.30. Helicopter-Only Approach.



15.36.3. Figure 15.31 is an example of a short final approach. The IAF is only 0.5 miles from the DME arc procedural track. The FAF to the MAP is 2.3 miles. While this approach should not be difficult to accomplish, careful review could prevent the pilot from becoming rushed during the maneuver.

Figure 15.31. Short Final Approach.



15.36.4. At locations where the MAP is located more than 2 statute miles from the landing site, the turn from the final approach to the visual segment is greater than 30 degrees, or the VFR segment from the MAP to the landing site has obstructions that require pilot actions to avoid them, a Point-In-Space (PinS) procedure may be developed (Figure 15.32 and Figure 15.33). These approaches are annotated “Proceed VFR from (MAP) or conduct the specified missed approach.” Some PinS approaches allow the pilot to fly to multiple heliports after reaching the MAP. If planning to use this type of approach, pay careful attention to weather conditions upon arrival, as VMC conditions are required to maneuver.

Figure 15.32. Point-in-Space (PinS) Approach.

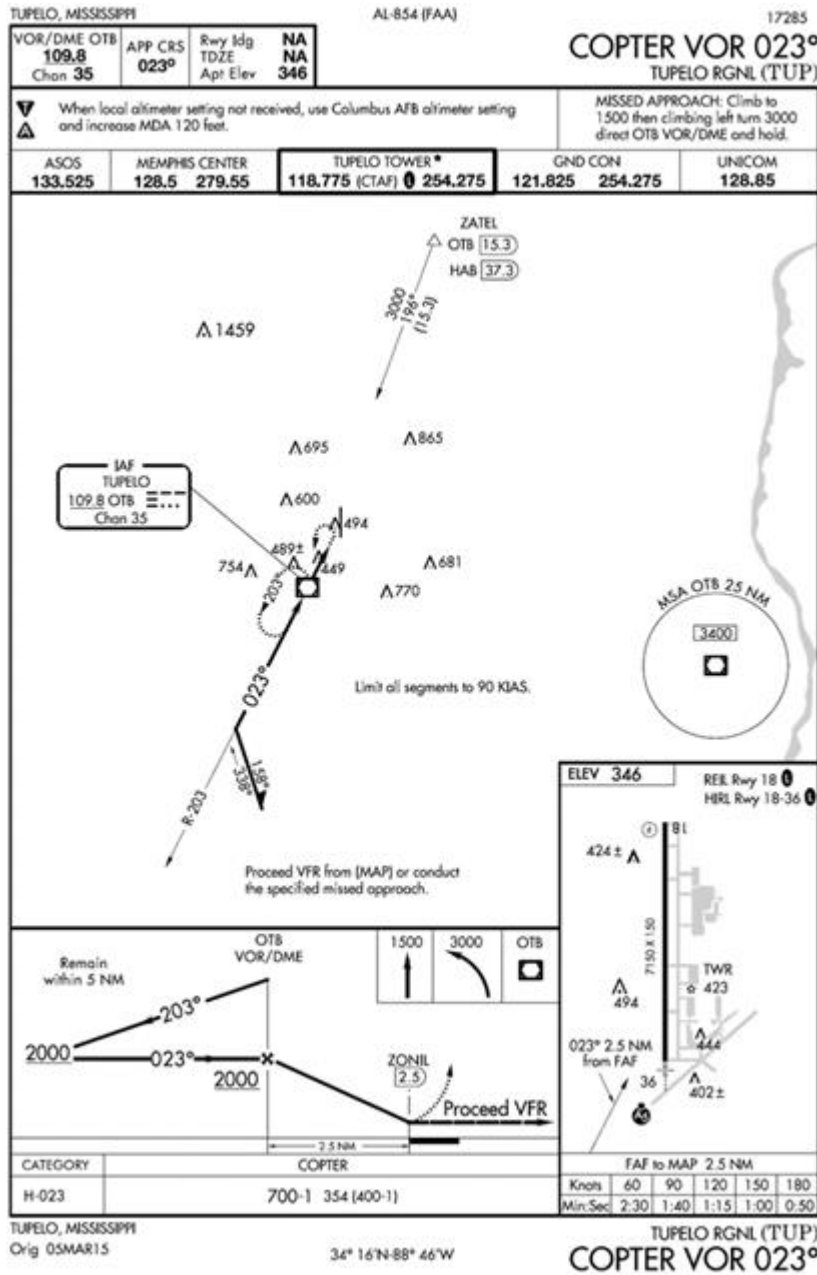
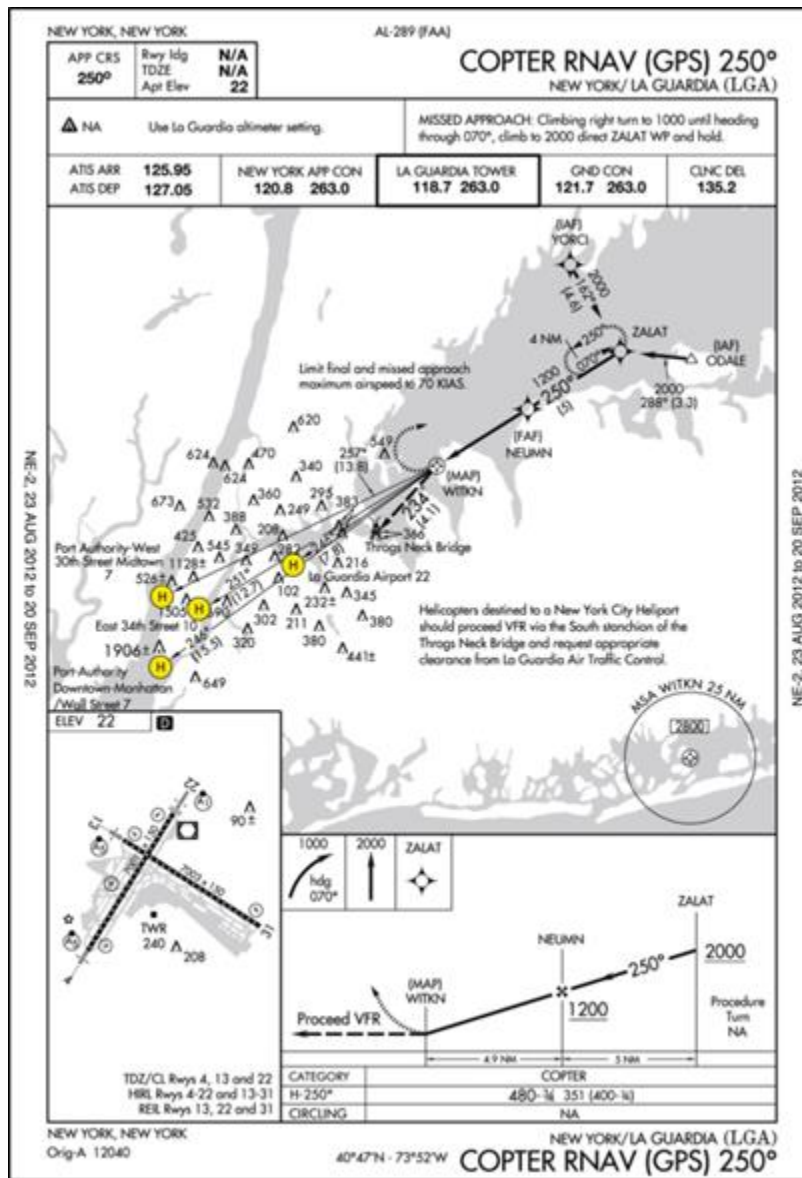


Figure 15.33. PinS Approach to Multiple Heliports.



**15.37. MAJCOM-Certified Approach.** At specific airfields, MAJCOMs may develop their own approach procedures for use by specific aircraft and MAJCOM-trained and -certified aircrews under specific conditions.

**15.38. Visual Approach.** [AIM 5-4-23] Visual approaches reduce pilot and controller workload and expedite traffic by shortening flight paths to the airfield. A visual approach is an IFR procedure conducted under IFR in VMC. Comply with controller’s instructions for vectors toward the airfield of intended landing or to a visual position behind a preceding aircraft. **(T-0)**.

15.38.1. A visual approach does not alter IFR flight plan cancellation responsibility. Radar service is automatically terminated without advising the pilot when instructed to change to advisory frequency.

15.38.2. If instructed by ATC to follow another aircraft, notify the controller if the aircraft to be followed is not in sight, unable to maintain visual contact with the aircraft to be followed, or for any other reason responsibility for visual separation cannot be assured. ATC may still clear the aircraft for a visual approach; however, ATC retains both aircraft separation and wake separation responsibility. When visually following a preceding aircraft, acceptance of the visual approach clearance constitutes acceptance of pilot responsibility for maintaining a safe approach interval and adequate wake turbulence separation.

15.38.3. After being cleared for a visual approach, proceed visually and clear of clouds to the airfield in the most direct and safe manner to establish the aircraft on a normal straight-in final approach. Clearance for a visual approach does not authorize the pilot to do an overhead or VFR traffic pattern.

15.38.4. A visual approach is not an instrument approach procedure and therefore does not have a missed approach segment. If a go-around is necessary for any reason, aircraft operating at controlled airfields are issued an appropriate advisory, clearance, or instruction by the tower. At non-towered airfields, aircraft are expected to remain clear of clouds and complete a landing as soon as possible. If a landing cannot be accomplished, the aircraft is expected to remain clear of clouds, contact ATC as soon as possible for further clearance (i.e., separation from other IFR aircraft is maintained under these circumstances).

15.38.5. [ICAO Doc 4444] The pilot must maintain visual reference to the terrain. **(T-1)**. The reported ceiling at the airfield must be at or above the initial approach altitude, or the pilot must report that meteorological conditions are such that a visual approach and landing can be completed. **(T-1)**. Visual approaches may be requested by the pilot or initiated by the controller. If initiated by the controller, in ICAO, concurrence by the pilot is required. Pilots will not fly visual approaches without ATC authorization. **(T-1)**.

15.38.6. [**NAS Only**] The pilot must have either the airfield or the preceding identified aircraft in sight, and the approach must be authorized and controlled by the appropriate ATC facility. **(T-0)**. The reported weather at the airfield must have a ceiling at or above 1000 feet and visibility of 3 miles or greater. **(T-0)**. **Note:** Helicopters making a PinS Approach may be requested to report when able to proceed to the landing area by visual reference to the prescribed surface route.

**15.39. Contact Approach (NAS Only).** A contact approach is a procedure that may be used by a pilot in lieu of conducting an instrument procedure to an airfield. It is not intended to be used to operate to an airfield without a published and functioning instrument procedure. Nor is it intended for an aircraft to conduct an approach to one airfield, and then when “in the clear”, discontinue that approach and proceed to another airfield.

15.39.1. Pilots operating on an IFR flight plan, when clear of clouds with at least 1 mile flight visibility and can reasonably expect to continue to the destination airfield in those conditions, may request ATC authorization for a contact approach.

15.39.2. ATC may authorize a contact approach provided:

15.39.2.1. The contact approach is specifically requested by the pilot. ATC cannot initiate this approach;

15.39.2.2. The reported ground visibility at the destination is at least 1 statute mile; and

15.39.2.3. The contact approach is made to an airfield having a published instrument approach procedure.

15.39.3. Advise ATC immediately if unable to continue the contact approach or if visibility is reduced to less than 1 mile.

15.39.4. When executing a contact approach, the pilot assumes responsibility for obstruction clearance. If radar service is being received, it automatically terminates when the pilot is instructed to change to advisory frequency.

15.39.5. Being cleared for a visual or contact approach does not authorize the pilot to fly a 360 degrees overhead traffic pattern. An aircraft conducting an overhead maneuver is VFR and the IFR flight plan is canceled when the aircraft reaches the initial point. Aircraft operating at an airfield without a functioning control tower must initiate cancellation of the IFR flight plan prior to executing the overhead maneuver. **(T-0)**.

**15.40. Charted Visual Flight Procedures.** Charted visual flight procedures may be established at airfields with control towers for environmental or noise abatement considerations as well as when necessary for safety and efficiency of air traffic operations (**Figure 15.34**). Designed primarily for turbojet aircraft, charted visual flight procedures depict prominent landmarks, courses, and recommended altitudes to a specific runway equipped with a visual or electronic vertical guidance. Most charted visual flight procedures also depict NAVAID information for supplemental navigation guidance only.

15.40.1. When informed charted visual flight procedures are in use, the pilot must advise the arrival controller on initial contact if unable to accept the charted visual flight procedure. **(T-0)**.

15.40.2. Pilots must have a charted visual landmark or a preceding aircraft in sight, and weather must be at or above the published minimums before ATC issues a charted visual flight procedure clearance. **(T-0)**.

15.40.3. Unless indicating a Class B airspace floor, all depicted altitudes are for noise abatement purposes and are recommended only. Pilots are not prohibited from flying other than recommended altitudes if operational requirements dictate. Weather minimums for charted visual flight procedures provide VFR cloud clearance at minimum vectoring altitudes. Therefore, clearance for a charted visual flight procedure is possible at MVA, which may be below the depicted altitudes.

15.40.4. When landmarks used for navigation are not visible at night, the approach is annotated “procedure not authorized at night.”

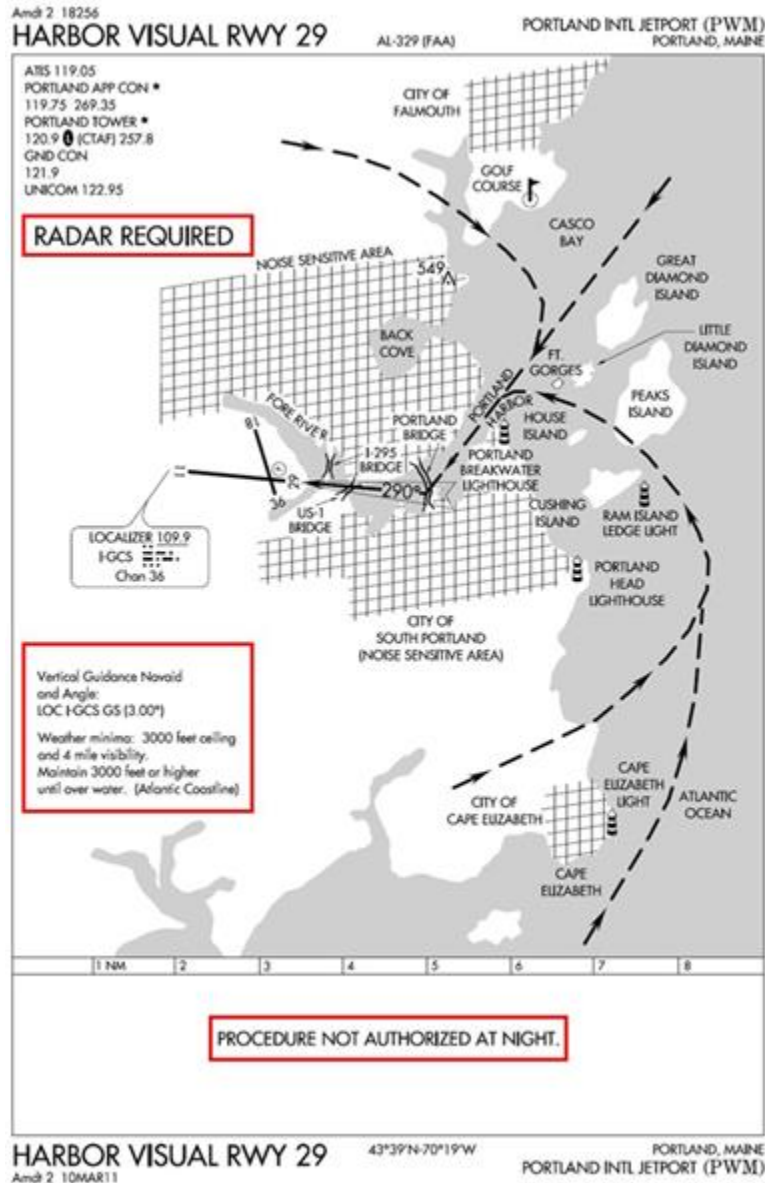
15.40.5. Charted visual flight procedures usually begin within 20 miles from the airfield.

15.40.6. Published weather minimums for charted visual flight procedures are based on minimum vectoring altitudes rather than recommended altitudes depicted on the charts.

15.40.7. ATC does not issue clearances for charted visual flight procedures when the weather is below the published minimum. When accepting a clearance to follow a preceding aircraft, pilots are responsible for maintaining a safe approach interval and wake turbulence separation. Pilots should advise ATC if at any point they are unable to continue an approach or lose sight of a preceding aircraft.

15.40.8. Charted visual flight procedures are not instrument approaches and do not have missed approach segments. The pilot should have preplanned climb-out options based on aircraft performance and terrain features.

**Figure 15.34. Charted Visual Flight Procedure.**



**15.41. Simultaneous Approaches to Parallel Runways.** [AIM 5-4-13] ATC procedures permit ILS, RNAV, or GLS instrument approach operations to dual or triple parallel runway configurations. Approaches to parallel runways are grouped into three classes: Simultaneous Dependent Approaches; Simultaneous Independent Approaches; and Simultaneous Close Parallel PRM Approaches ([Figure 15.35](#)).

15.41.1. RNAV approach procedures that are approved for simultaneous operations require GNSS as the sensor for position updating; VOR/DME, DME/DME and IRU position updating are NA.



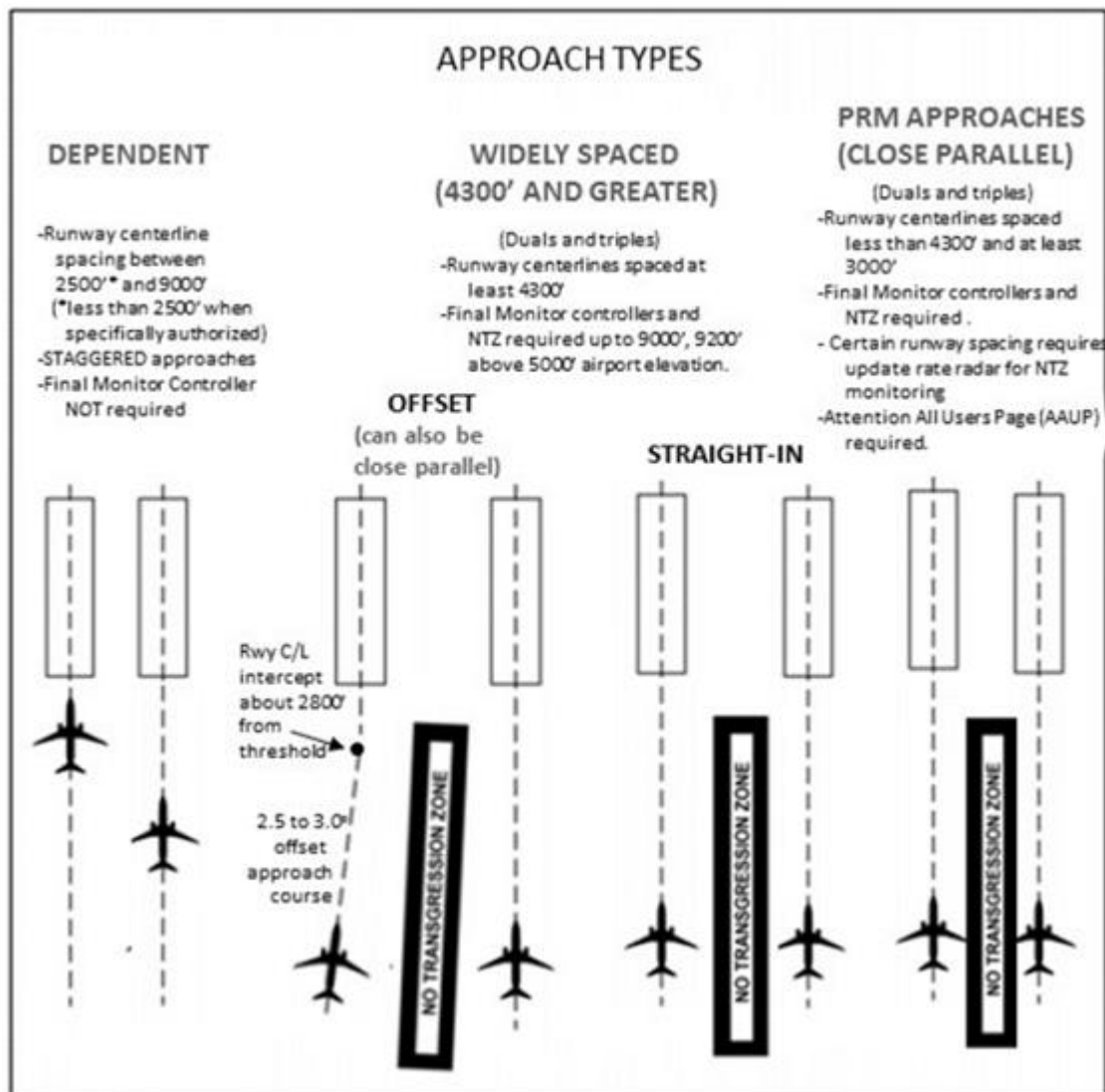
15.41.2. The classification of a parallel runway approach procedure is dependent on adjacent parallel runway centerline separation, ATC procedures, and airfield ATC final approach radar monitoring and communications capabilities.

15.41.3. At some airfields, one or more approach courses may be offset up to 3 degrees. ILS approaches with offset localizer configurations result in loss of CAT II/III capabilities and an increase in the DH (50 feet).

15.41.4. Depending on weather conditions, traffic volume, and the specific combination of runways being utilized for arrival operations, a runway may be used for different types of simultaneous operations to include closely spaced dependent or independent approaches. Pilots should ensure that they understand the type of operation that is being conducted and ask ATC for clarification if necessary.

15.41.5. Refer to [Chapter 17](#) for simultaneous close parallel PRM approaches.

**Figure 15.35. Simultaneous Approaches to Parallel Runways.**

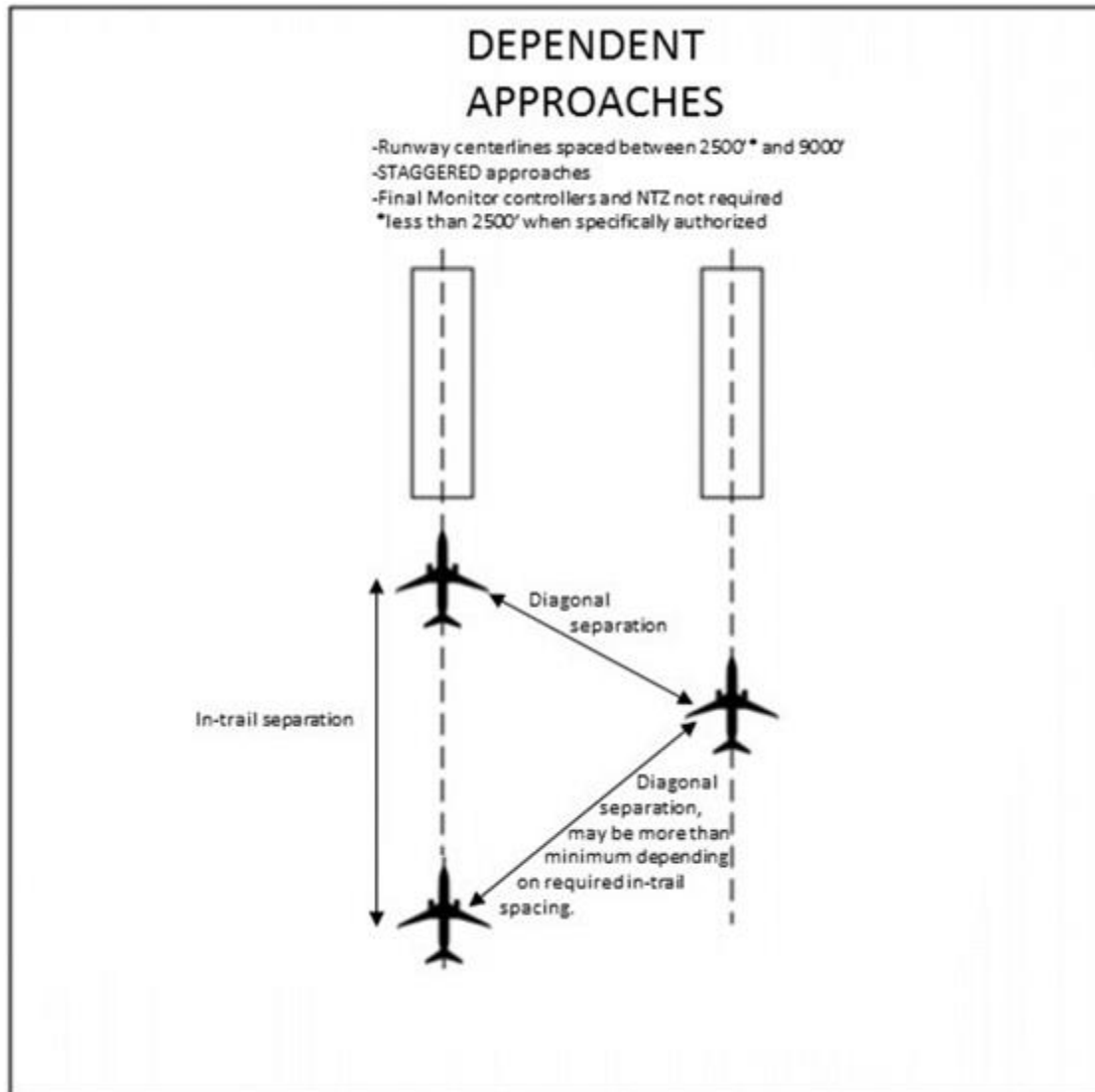


**15.42. Simultaneous Dependent Approaches.** [AIM 5-4-14] Simultaneous dependent approaches are an ATC procedure permitting approaches to airfields having parallel runway centerlines separated by at least 2,500 feet up to 9,000 feet (**Figure 15.36**).

15.42.1. Although non-precision minimums may be published, pilots must only use those procedures specifically authorized by chart note. **(T-0)**.

15.42.2. A simultaneous dependent approach differs from a simultaneous independent approach in that, the minimum distance between parallel runway centerlines may be reduced; there is no requirement for radar monitoring or advisories and a staggered separation of aircraft on the adjacent final course is required.

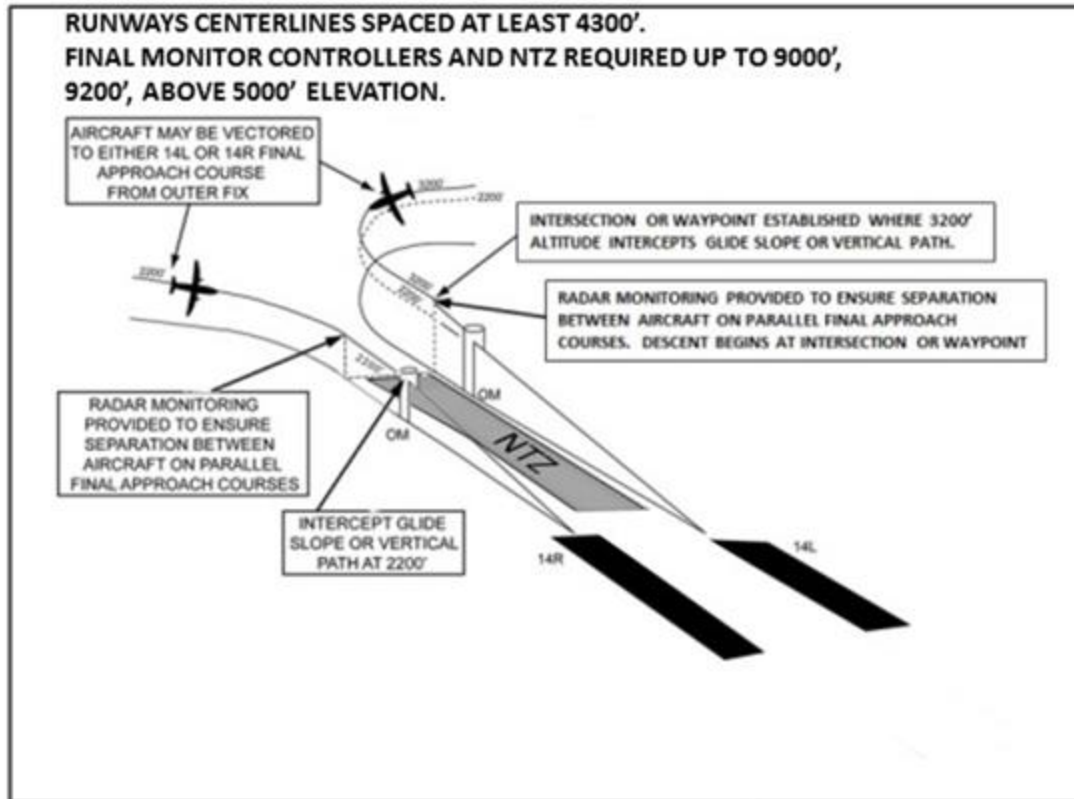
**Figure 15.36. Simultaneous Dependent Approaches.**



**15.43. Simultaneous Independent Approaches.** [AIM 5-4-15] An approach system permitting simultaneous ILS, RNAV, or GLS approaches to parallel runways with centerlines separated by

4,300 to 9,000 feet (9,200 feet for airfields above 5,000 feet elevation) utilizing no-transgression zone final monitor controllers (Figure 15.37).

Figure 15.37. Simultaneous (Parallel) Independent Approaches.



15.44. Simultaneous Converging Instrument Approaches. [AIM 5-4-17] ATC may conduct instrument approaches simultaneously to converging runways (i.e., runways having an included angle from 15 to 100 degrees) at airfields where a program has been specifically approved to do so. The basic concept requires that dedicated, separate standard instrument approach procedures be developed for each converging runway included. These approaches can be identified by the letter “V” in the title; for example, “ILS V RWY 17 (CONVERGING)” (Figure 15.38).

Figure 15.38. Simultaneous Converging Instrument Approach.

|                            |   |                    |                                  |   |
|----------------------------|---|--------------------|----------------------------------|---|
| PHILADELPHIA, PENNSYLVANIA |   |                    | AL-320 (FAA)                     | 18032   |
| LOC/DME I- <b>PHL</b>      | APP CRS   | Rwy Idg            | <b>ILS V RWY 9R (CONVERGING)</b> |   |
| <b>109.3</b>               | <b>087°</b>   | <b>10506</b>       | PHILADELPHIA INTL (PHL)          |   |
| Chan <b>30</b>             |   | TDZE <b>21</b>     |                                  |   |
|                            |   | Apt Elev <b>36</b> |                                  |   |
| <b>⚠</b> NA                | <b>Simultaneous approach authorized.</b><br>For inop ALS, increase S-ILS 9R all<br>Cats visibility to 2 SM. |                    | ALSF-2                           | MISSED APPROACH: Climbing right turn<br>to 3000 direct OOD VORTAC and hold. |
| D-ATIS                     | PHILADELPHIA TOWER  |                    |                                  |   |

## Chapter 16

### FINAL APPROACH

**16.1. General.** [AIM 5-4-5] Final approach guidance is categorized as non-radar, radar, procedures with a visual component (visual approach, contact approach, approaches with a visual segment and charted visual chart procedures), MAJCOM-certified approaches, or specialized procedures (converging approaches, simultaneous dependent and independent parallel approaches). Once inside the FAF, one navigation receiver available to the pilot flying must remain tuned to and display the facility that provides final approach course guidance. **(T-0)**.

**16.2. Final Approach Components.** In general, the final approach segment consists of glideslope or glidepath angles, intercept altitudes, FAF, stepdown fixes, visual descent point (VDP), VDA, MAP, MDA and DA. The FAF, stepdown fixes, VDP and the MAP can be defined by a NAVAID, RADAR, a waypoint, crossing radials of two NAVAIDs, or a radial and DME. The optimum final approach course length is 5 miles but may be up to 10 miles.

16.2.1. For a precision approach or approach with vertical guidance, the final approach segment begins where the glidepath intercepts the minimum glidepath intercept altitude indicated on the approach chart by the lightning bolt symbol. If ATC authorizes a lower intercept altitude, the final approach segment begins upon glideslope or glidepath interception at that altitude.

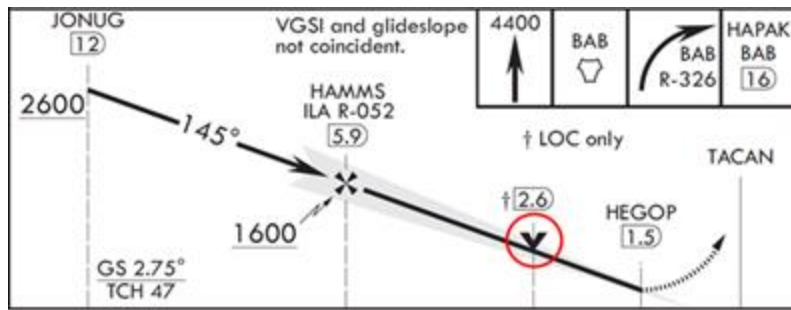
16.2.2. For a non-precision approach, the final approach segment begins either at the FAF depicted by a “Maltese cross” in the profile view of the approach along with a recommended, minimum, or mandatory crossing altitude; or at the point where the aircraft is established inbound on the final approach course where no FAF is depicted. Normally, aircraft cross the FAF at approach speed in the landing configuration.

**16.3. Visual Descent Point (VDP).** The VDP is a defined point on the final approach course of a non-precision approach straight-in procedure from which a stabilized descent from the MDA to the runway touchdown point may be commenced (**Figure 16.1**). Pilots should not descend below MDA prior to reaching the VDP. The VDP is identified by DME or area navigation along-track distance (i.e., LNAV only approaches) to the MAP. The VDP is based on the lowest MDA published on the instrument procedure and is harmonized with the angle of the VGSI if installed or the procedure VDA when not installed. If flying a higher MDA (e.g., higher category, higher mins required) calculate a new VDP. VDPs are not a mandatory part of the procedure.

16.3.1. While pilots should calculate a VDP if one is not published, use extreme caution when departing the MDA, as there may be an obstacle penetrating the 20:1 surface. Unless familiar with the airfield, if visibility is limited, consider remaining at the MDA even if the runway environment is in sight if terrain and obstacles along the final approach cannot be discerned.

16.3.2. Divide the HAT by the desired descent angle in degrees times 100. For example, a HAT of 450 feet and a desired descent angle to the runway of 3 degrees:  $450 \div (3 \times 100) = 1.5$  miles to descend from the MDA to TDZE.

Figure 16.1. VDP.



**16.4. Vertical Descent Angle (VDA).** VDAs are published to the maximum extent possible on non-precision approaches except those published in conjunction with vertically guided minimums (e.g., ILS, LNAV/VNAV, LPV), no-FAF procedures without stepdown fixes, or circling-only approaches. The published angle is for information only as it does not guarantee obstacle clearance below the MDA in the visual segment. Use the published angle and groundspeed to find a target rate of descent that can be flown with the vertical velocity indicator (VVI). When there are obstacles in the visual area between the MDA and touchdown, the instrument procedure does not show a VDA in the profile view and one of two statements is charted in the profile view: “Visual Segment-Obstacles” (Figure 16.2) or “Descent Angle NA” (Figure 16.3). A chart note indicates if the VGSI is not coincident with the VDA.

Figure 16.2. Visual Segment – Obstacles.

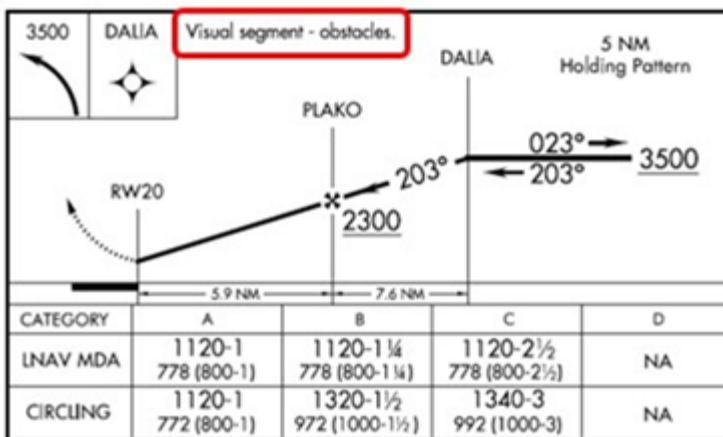
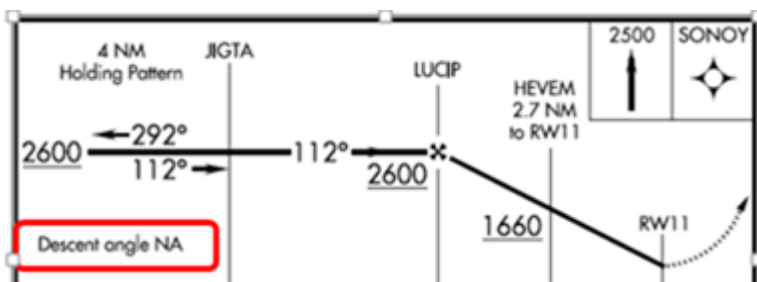


Figure 16.3. Descent Angle NA.



**16.5. Continuous Descent Final Approach (CDFA).** [ICAO Doc 8168 Volume 1; AC 120-108] Many ICAO States require the use of the CDFA technique and apply increased visibility or RVR requirements when the technique is not used. Pilots should use the CDFA technique when practicable.

16.5.1. [EU-OPS 1] Civil operators in the EU must fly all non-precision approaches using the CDFA technique unless otherwise approved by the authority for a specific approach to a particular runway. An increase to the approach minima is required if the CDFA technique is not used. Refer to the FLIP AP series or the ICAO State AIP for exceptions.

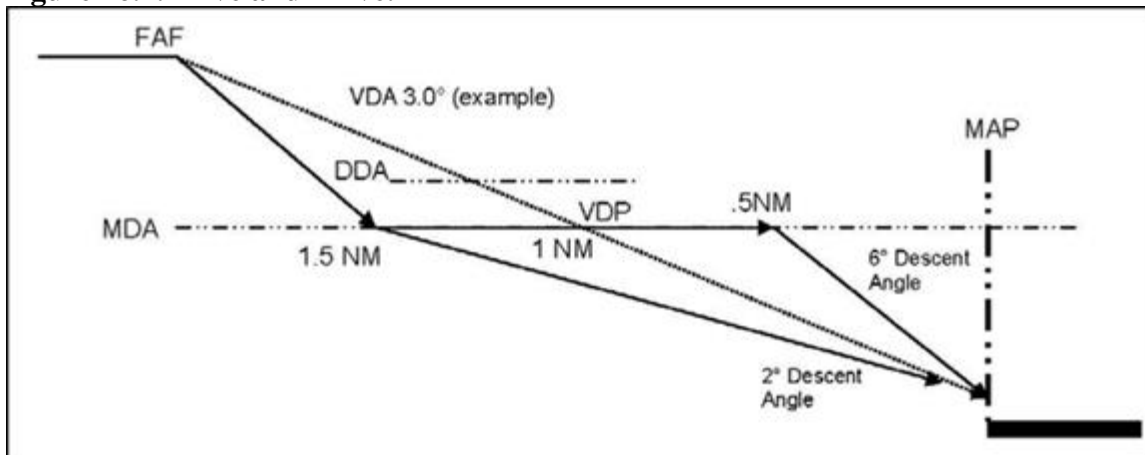
16.5.2. CDFA is the preferred method that allows for flying the final approach segment of a non-precision approach as a continuous descent. It is consistent with stabilized approach procedures and has no level-off. A CDFA starts from an altitude or height at or above the FAF and proceeds to an altitude or height approximately 50 feet above the landing runway threshold or to a point where the flare maneuver should begin for the type of aircraft being flown. This method harmonizes USAF flight operations with FAA, European Aviation Safety Agency and ICAO standards.

16.5.3. Controlled flight into terrain (CFIT) is a primary cause of worldwide commercial aviation fatal accidents. Unstable approaches are a key contributor to CFIT events. Non-precision approaches are designed with and without stepdown fixes in the final segment. Stepdowns flown without a constant descent require multiple thrust, pitch, and altitude adjustments inside the FAF. These adjustments increase pilot workload and potential errors during a critical phase of flight. Non-precision approaches designed without stepdown fixes in the final segment allow pilots to immediately descend to the MDA after crossing the FAF. In both cases, the aircraft remains at the MDA until descending for the runway or reaching the MAP. This practice is commonly referred to as “dive and drive,” can result in extended level flight as low as 250 feet AGL in IMC and shallow or steep final approaches.

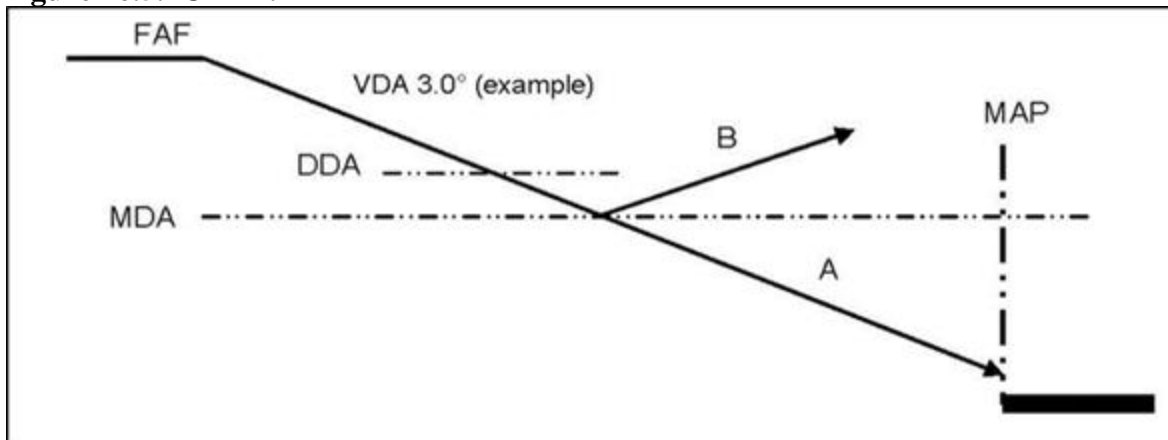
16.5.3.1. **Figure 16.4** is an example of an aircraft leveled at the MDA (“dive and drive”) and is proceeding to the MAP to acquire the visual references to continue the approach below the MDA. The 3.0 degree VDA would be used in this example to fly a CDFA.

16.5.3.2. As the aircraft approaches the published MAP, the required descent angle to the runway threshold steepens. At approximately 0.5 nautical miles from the MAP, the required angle increases to 6 degrees. At a groundspeed of 120 knots, a 1,270 foot per minute rate of descent would be required to cross the threshold at the planned TCH of 50 feet. The steep final angle, low-power setting and high descent rate may result in an unstable approach and unsafe condition in the transition to landing.

16.5.3.3. If the pilot descends 0.5 nautical miles early, a 2 degree descent angle is required. At a groundspeed of 120 knots, this corresponds to a 425 foot per minute rate of descent. Higher power settings and increased deck angles are required.

**Figure 16.4. Dive and Drive.**

16.5.4. **Figure 16.5** is an example of using a CDFA. In this example, flying the VDA or CDFA from the FAF results in reaching the DDA and MDA prior to the published MAP. The pilot has two courses of action: continue visually to the landing runway if the required visual cues are acquired or execute a missed approach.

**Figure 16.5. CDFA.**

16.5.5. A stabilized approach is a key feature to a safe approach and landing. Operators are encouraged by the FAA and ICAO to use the stabilized approach concept to help eliminate CFIT. The stabilized approach concept is characterized by maintaining a stable approach speed, descent rate, vertical flightpath, and configuration to the landing touchdown point. Depart the FAF configured for landing and on the proper approach speed, power setting, and flightpath before descending below the minimum stabilized approach height.

16.5.6. Precision instrument procedures and approach procedures with vertical guidance have a continuous descent approach profile in their design. Non-precision approaches were not originally designed with this vertical path but may easily be flown using the CDFA technique. Flying non-precision approaches with a continuous descent profile provides a safety advantage over flying approaches using the “dive and drive” technique. CDFA has several advantages:

16.5.6.1. Increased safety by employing the concepts of stabilized approach criteria and procedure standardization;



16.5.6.2. Improved situational awareness and reduces pilot workload;

16.5.6.3. Improved fuel efficiency by minimizing the low-altitude level flight time;

16.5.6.4. Reduced noise level (noise abatement) by minimizing the level flight time at high thrust settings;

16.5.6.5. Procedural similarities to precision approach operations; and

16.5.6.6. Reduced probability of infringement on required obstacle clearance during the final approach segment.

16.5.7. CDFAs require the use of a published VDA or barometric vertical guidance on the instrument procedure. RNAV approaches with LNAV/VNAV minima are published with a glidepath. Non-precision approach or RNAV approaches with LNAV only minima are published with a VDA. Aircraft with FMS, Baro-VNAV, or WAAS typically provide the published glidepath or VDA when the instrument procedure is selected from the database. Aircraft equipped with flight path angle allow the pilot to enter an electronic descent angle based on the published glidepath or VDA.

16.5.8. Pilots should use the “Instrument Takeoff or Approach Procedure Charts Rate of Climb/Descent Table” on the inside back cover (or EFB legend) of the terminal procedures publication to convert the published VDA or glideslope into the required rate of descent (Figure 16.6).

**Figure 16.6. Find Descent Gradient.**

| INSTRUMENT TAKEOFF OR APPROACH PROCEDURE CHARTS<br>RATE OF CLIMB/DESCENT TABLE<br>(ft. per min)   |      |                      |     |     |     |      |      |      |      |      |      |       |      |
|---|------|----------------------|-----|-----|-----|------|------|------|------|------|------|-------|------|
| A rate of climb/descent table is provided for use in planning and executing climbs or descents under known or approximate ground speed conditions. It will be especially useful for approaches when the localizer only is used for course guidance. A best speed, power, altitude combination can be programmed which will result in a stable glide rate and altitude favorable for executing a landing if minimums exist upon breakout. Care should always be exercised so that minimum descent altitude and missed approach point are not exceeded. |      |                      |     |     |     |      |      |      |      |      |      |       |      |
| ft./NM  | %    | GROUND SPEED (knots) |     |     |     |      |      |      |      |      |      | ANGLE |      |
|   |      | 40                   | 90  | 120 | 150 | 180  | 210  | 240  | 270  | 300  | 330  |       | 360  |
| 12  | 2.50 | 150                  | 230 | 300 | 380 | 460  | 530  | 610  | 680  | 760  | 840  | 910   | 1.43 |
| 20  | 3.29 | 200                  | 300 | 400 | 500 | 600  | 700  | 800  | 900  | 1000 | 1100 | 1200  | 1.89 |
| 20  | 3.46 | 210                  | 320 | 420 | 530 | 630  | 740  | 840  | 950  | 1050 | 1160 | 1260  | 1.98 |
| 20  | 3.62 | 220                  | 330 | 440 | 550 | 660  | 770  | 880  | 990  | 1100 | 1210 | 1320  | 2.07 |
| 20  | 3.79 | 230                  | 350 | 460 | 580 | 690  | 810  | 920  | 1040 | 1150 | 1270 | 1380  | 2.17 |
| 20  | 3.95 | 240                  | 360 | 480 | 600 | 720  | 840  | 960  | 1080 | 1200 | 1320 | 1440  | 2.26 |
| 20  | 4.11 | 250                  | 380 | 500 | 630 | 750  | 880  | 1000 | 1130 | 1250 | 1380 | 1500  | 2.36 |
| 20  | 4.28 | 260                  | 390 | 520 | 650 | 780  | 910  | 1040 | 1170 | 1300 | 1430 | 1560  | 2.45 |
| 20  | 4.44 | 270                  | 410 | 540 | 680 | 810  | 950  | 1080 | 1220 | 1350 | 1490 | 1620  | 2.54 |
| 20  | 4.61 | 280                  | 420 | 560 | 700 | 840  | 980  | 1120 | 1260 | 1400 | 1540 | 1680  | 2.64 |
| 20  | 4.77 | 290                  | 440 | 580 | 730 | 870  | 1020 | 1160 | 1310 | 1450 | 1600 | 1740  | 2.73 |
| 30  | 4.94 | 300                  | 450 | 600 | 750 | 900  | 1050 | 1200 | 1350 | 1500 | 1650 | 1800  | 2.83 |
| 30  | 5.10 | 310                  | 470 | 620 | 780 | 930  | 1090 | 1240 | 1400 | 1550 | 1710 | 1860  | 2.92 |
| 30  | 5.27 | 320                  | 480 | 640 | 800 | 960  | 1120 | 1280 | 1440 | 1600 | 1760 | 1920  | 3.01 |
| 30  | 5.43 | 330                  | 500 | 660 | 830 | 990  | 1160 | 1320 | 1490 | 1650 | 1820 | 1980  | 3.11 |
| 340   |      | 340                  | 510 | 680 | 850 | 1020 | 1190 | 1360 | 1530 | 1700 | 1870 | 2040  | 3.20 |
| 350   | 5.76 | 350                  | 530 | 700 | 880 | 1050 | 1230 | 1400 | 1580 | 1750 | 1930 | 2100  | 3.30 |
| 360   | 5.92 | 360                  | 540 | 720 | 900 | 1080 | 1260 | 1440 | 1620 | 1800 | 1980 | 2160  | 3.39 |

16.5.9. Find the descent rate based on groundspeed. In Figure 16.7, with a 3.2 degree VDA and a groundspeed of 150 KIAS, the descent rate is 850 feet per minute.

Figure 16.7. Find Descent Rate.

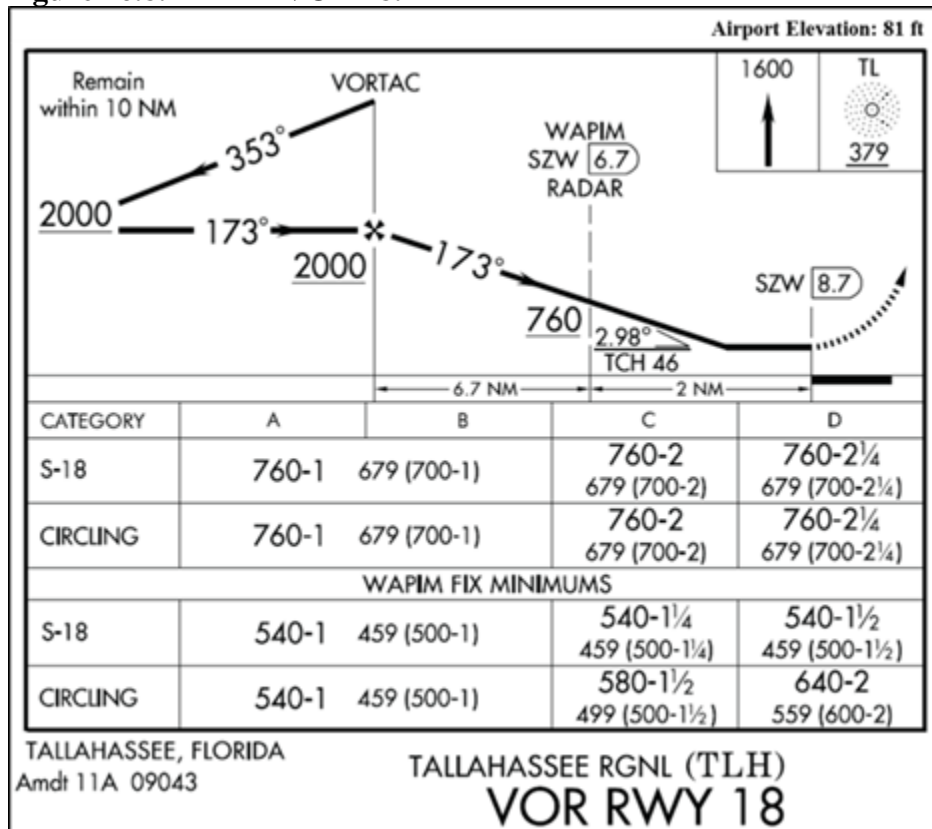
INSTRUMENT TAKEOFF OR APPROACH PROCEDURE CHARTS  
RATE OF CLIMB/DESCENT TABLE  
(ft. per min)

A rate of climb/descent table is provided for use in planning and executing climbs or descents under known or approximate ground speed conditions. It will be especially useful for approaches when the localizer only is used for course guidance. A best speed, power, altitude combination can be programmed which will result in a stable glide rate and altitude favorable for executing a landing if minimums exist upon breakout. Care should always be exercised so that minimum descent altitude and missed approach point are not exceeded.

| ft./NM | %    | GROUND SPEED (knots) |     |     |     |      |      |      |      |      |      |      | ANGLE |
|--------|------|----------------------|-----|-----|-----|------|------|------|------|------|------|------|-------|
|        |      | 60                   | 90  | 120 | 150 | 180  | 210  | 240  | 270  | 300  | 330  | 360  |       |
| 152    | 2.50 | 150                  | 230 | 300 | 360 | 460  | 530  | 610  | 680  | 760  | 840  | 910  | 1.43  |
| 200    | 3.29 | 200                  | 300 | 400 | 500 | 600  | 700  | 800  | 900  | 1000 | 1100 | 1200 | 1.89  |
| 210    | 3.46 | 210                  | 320 | 420 | 520 | 630  | 740  | 840  | 950  | 1050 | 1160 | 1260 | 1.98  |
| 220    | 3.62 | 220                  | 330 | 440 | 550 | 660  | 770  | 880  | 990  | 1100 | 1210 | 1320 | 2.07  |
| 230    | 3.79 | 230                  | 350 | 460 | 570 | 690  | 810  | 920  | 1040 | 1150 | 1270 | 1380 | 2.17  |
| 240    | 3.95 | 240                  | 360 | 480 | 600 | 720  | 840  | 960  | 1080 | 1200 | 1320 | 1440 | 2.26  |
| 250    | 4.11 | 250                  | 380 | 500 | 620 | 750  | 880  | 1000 | 1130 | 1250 | 1380 | 1500 | 2.36  |
| 260    | 4.28 | 260                  | 390 | 520 | 640 | 780  | 910  | 1040 | 1170 | 1300 | 1430 | 1560 | 2.45  |
| 270    | 4.44 | 270                  | 410 | 540 | 670 | 810  | 950  | 1080 | 1220 | 1350 | 1490 | 1620 | 2.54  |
| 280    | 4.61 | 280                  | 420 | 560 | 700 | 840  | 980  | 1120 | 1260 | 1400 | 1540 | 1680 | 2.64  |
| 290    | 4.77 | 290                  | 440 | 580 | 720 | 870  | 1020 | 1160 | 1310 | 1450 | 1600 | 1740 | 2.73  |
| 300    | 4.94 | 300                  | 450 | 600 | 750 | 900  | 1050 | 1200 | 1350 | 1500 | 1650 | 1800 | 2.83  |
| 310    | 5.10 | 310                  | 470 | 620 | 770 | 930  | 1090 | 1240 | 1400 | 1550 | 1710 | 1860 | 2.92  |
| 320    | 5.27 | 320                  | 480 | 640 | 800 | 960  | 1120 | 1280 | 1440 | 1600 | 1760 | 1920 | 3.01  |
| 330    | 5.43 | 330                  | 500 | 660 | 820 | 990  | 1160 | 1320 | 1490 | 1650 | 1820 | 1980 | 3.11  |
| 340    | 5.60 | 340                  | 510 | 680 | 850 | 1020 | 1190 | 1360 | 1530 | 1700 | 1870 | 2040 | 3.20  |
| 350    | 5.76 | 350                  | 530 | 700 | 880 | 1050 | 1230 | 1400 | 1580 | 1750 | 1930 | 2100 | 3.30  |
| 360    | 5.92 | 360                  | 540 | 720 | 900 | 1080 | 1260 | 1440 | 1620 | 1800 | 1980 | 2160 | 3.39  |

16.5.10. The VDA is calculated from the FAF altitude to the TCH. On approaches with stepdown fixes, the goal is to publish a VDA that clears the stepdown fix altitude. The VDA may be calculated from the stepdown fix altitude to the TCH. In this situation, the VDA is published on the instrument procedure following the associated stepdown fix. The descent angle between the FAF altitude and the stepdown fix altitude is often shallower than the published VDA (Figure 16.8). Pilots should plan to descend beyond the FAF at the published VDA and clear the stepdown fix altitude.

Figure 16.8. KTLH VOR 18.



16.5.10.1. To calculate the descent point beyond the FAF, first determine the desired altitude to lose: FAF (2,000 feet) – [airport elevation (81 feet) + TCH (46 feet)] = 1,873 feet. Divide the desired altitude to lose (1,873 feet) by the descent gradient (316 feet per nautical mile). This produces a distance of 5.9 nautical miles from the runway threshold, which is a point approximately 2.8 DME beyond the FAF (Figure 16.9).

Figure 16.9. Calculating a CDFA Descent Point beyond the FAF.

$$\begin{aligned}
 &= \frac{FAF - (Airport\ Elevation + TCH)}{Descent\ Gradient} \\
 &= \frac{2000ft - (81ft + 46ft)}{316ft/NM} = \frac{1873ft}{316ft/NM} = 5.9NM
 \end{aligned}$$

16.5.11. Do not descend below the MDA when executing a missed approach from a CDFA. (T-0). A DDA is an altitude above the MDA where a missed approach should be initiated to ensure the aircraft does not descend below the published MDA. Follow aircraft flight manual guidance for DDA; MAJCOMs will establish acceptable methods for calculating DDA if aircraft flight manual guidance does not adequately address DDA (e.g., use of demonstrated altitude lost in a go-around, use of industry practice 50 feet above the MDA as the DDA).

16.5.11. (AFMC) Use 50 feet above MDA for DDA unless flight manual requires/specifies another technique.

## 16.6. Flying the Approach.

16.6.1. Avoid rapid descents on final by crossing the FAF at the published altitude. When a turn is required over the FAF, turn immediately and intercept the final approach course to remain within the protected airspace. Do not descend to the MDA or stepdown fix altitude until past the FAF. When the FAF is identified by the NAVAID for the approach, a straight-in approach course change of up to 30 degrees may be published. To determine the approximate initial descent rate required on final, refer to the VVI chart in the instrument procedure or use one of the formulas provided in [Attachment 2](#).

16.6.2. Timing is required when the final approach does not terminate at a published fix. When timing is used to identify the MAP, begin timing when passing the FAF or the starting point designated in the timing block on the instrument procedure. This point is usually the FAF but it may be a fix not co-located with the FAF such as an outer marker (OM), NDB, crossing radial, or DME fix. Time and distance tables on the approach chart are based on groundspeed.

16.6.2.1. If timing is not specifically depicted on the instrument approach procedure, timing is NA as a means of identifying the MAP.

16.6.2.2. If both timing and another means of identifying the MAP are published (e.g., DME), timing is normally only used as a backup unless the other means of MAP identification is not operational.

**16.7. Runway Environment.** Aircrew will not descend below MDA, DA, or DH until sufficient visual reference with the runway environment has been established and the aircraft is in position to execute a safe landing. **(T-0)**.

16.7.1. The runway environment consists of one or more of the following elements:

16.7.1.1. The approach light system.

16.7.1.2. The runway end identifier lights.

16.7.1.3. The runway lights.

16.7.1.4. The visual approach slope indicator (VASI).

16.7.1.5. The threshold, threshold markings, or threshold lights.

16.7.1.6. The touchdown zone, touchdown zone markings, or touchdown zone lights.

16.7.1.7. The runway or runway markings.

16.7.2. The pilot will not descend below 100 feet above the TDZE using the approach lights as a reference unless the red terminating bars or the red side row bars are also distinctly visible and identifiable. **(T-0)**.

**16.8. ILS or LOC.** Required components of the ILS are the glideslope, localizer, and outer marker.

16.8.1. If the OM is inoperative or not installed, it may be replaced by DME. **Note: (NAS Only)** The OM may be replaced by another NAVAID, a crossing radial, a waypoint, or a radar

fix, provided these substitutes are depicted on the approach plate or identified by NOTAM [FAA Order 6750.24].

16.8.2. If the glideslope fails or is unavailable, the approach reverts to an approach without glidepath guidance.

16.8.3. The ILS or LOC approach must be discontinued if the localizer course becomes unreliable, or any time full-scale deflection of the CDI occurs on final approach. **(T-0)**.

16.8.4. [FAA Order 6750.24] An OM or suitable substitute is only required to indicate the FAF for non-precision approach operations (i.e., LOC only). The FAF for ILS approach operations is the published glideslope intercept altitude, not the OM. Therefore, an OM or suitable substitute is not required for ILS approach operations.

16.8.5. Airborne marker beacon receivers that have a selective sensitivity feature should always be operated in the “low” sensitivity position.

16.8.6. If making an autopilot coupled approach or auto land operations, use the aircraft flight manual procedures for the category of ILS approach being conducted. When the ceiling is less than 800 feet or the visibility of less than 2 miles, vehicles and aircraft are not authorized in or over the ILS critical area when an arriving aircraft is between the ILS FAF and the airfield (except for aircraft that land, exit a runway, depart or execute a missed approach). When executing either an autopilot coupled approach or auto land operations and the ceiling is above 800 feet and the visibility is more than 2 miles, the pilot should advise ATC as soon as practical but not later than the FAF. This allows time for clearance of the appropriate ILS critical area or for an advisory issuance.

16.8.6.1. If controllers advise “localizer or glideslope signal not protected,” be alert for unstable or fluctuating ILS indications that may prevent an autopilot-coupled approach.

16.8.6.2. When aircraft equipment and crew qualification permit, the localizer and glideslope may be used for autopilot operations to the points specified in FLIP for each category of ILS approach, unless a restriction is published on the approach procedure.

16.8.7. Set the published localizer front course in the course selector window prior to attempting localizer interception for ILS, LOC, and LOC Back Course (LOC BC) approaches. On a LOC BC, the term “front course” refers to the inbound course depicted on the ILS or LOC approach for the opposite runway. Follow aircraft flight manual guidance for aircraft specific procedures.

16.8.7.1. Unless the aircraft’s ILS equipment includes reverse sensing capability, when flying inbound on the back course it is necessary to steer the aircraft in the direction opposite the needle deflection when making corrections from off-course to on-course. This “fly away from the needle” is also required when flying outbound on the front course of the localizer. Do not use back course signals for approach unless a LOC BC instrument procedure is published for that particular runway and the approach is authorized by ATC.

16.8.7.2. [AIM 1-1-9] False glideslope signals may exist around the localizer back course approach which can cause the glideslope flag alarm to disappear and present unreliable glideslope indications. Disregard all glideslope signal indications when making a localizer back course approach unless a glideslope is specified on the approach and landing chart.

16.8.8. [AIM 1-1-9] Be alert when approaching the glideslope intercept. False courses and reverse sensing occur at angles considerably greater than the published glidepath. Where available, use other NAVAIDs to help identify the localizer course and glideslope intercept point.

16.8.9. Do not descend below localizer minimums if the aircraft is more than half-scale below or full scale above the glideslope. If the glideslope is recaptured to within the above tolerance, descent may be continued to the DA.

16.8.10. The middle marker (MM) may not be used as the sole means of identifying the MAP. If the MM is the only way to identify the MAP (e.g., no timing published or DME out of service), then the approach is not authorized. Although the MM cannot be the sole means, it may assist the pilot in identifying the MAP on certain localizer approaches. To determine the location of the MAP, compare the distance from the FAF to MAP adjacent to the timing block. It may not be the same point as depicted in the profile view. If the MM is received while executing such an approach, and the primary indications (e.g., DME or timing) agree, consider the aircraft to be at the MAP and take appropriate action.

### **16.9. RNAV (GPS) and GPS Approach Procedures.**

16.9.1. Unless circling from the approach, VNAV guidance should be followed if provided by aircraft avionics and certified for use by the MAJCOM.

16.9.2. VNAV guidance may be used to LNAV minimums; however, the aircraft must level off at the MDA or utilize a DDA if the runway environment is not in sight. **(T-0)**. Due to the temperature and pressure altitude effects, USAF crews will not use VNAV guidance below any published MDA or DA. **(T-0)**.

16.9.3. Do not activate the missed approach lateral navigation or turn away from the final approach course prior to the missed approach waypoint. **(T-2)**.

**16.10. Visual Segment.** Some instrument procedures contain a published visual segment (**Figure 16.10**). The visual segment of an instrument procedure begins at the DA or MDA and continues to the runway. The words “Fly Visual” or “Fly Visual to Airport” appear in the profile view of the instrument procedure. A dashed line in the profile view with an approximate heading and distance to the end of the runway.

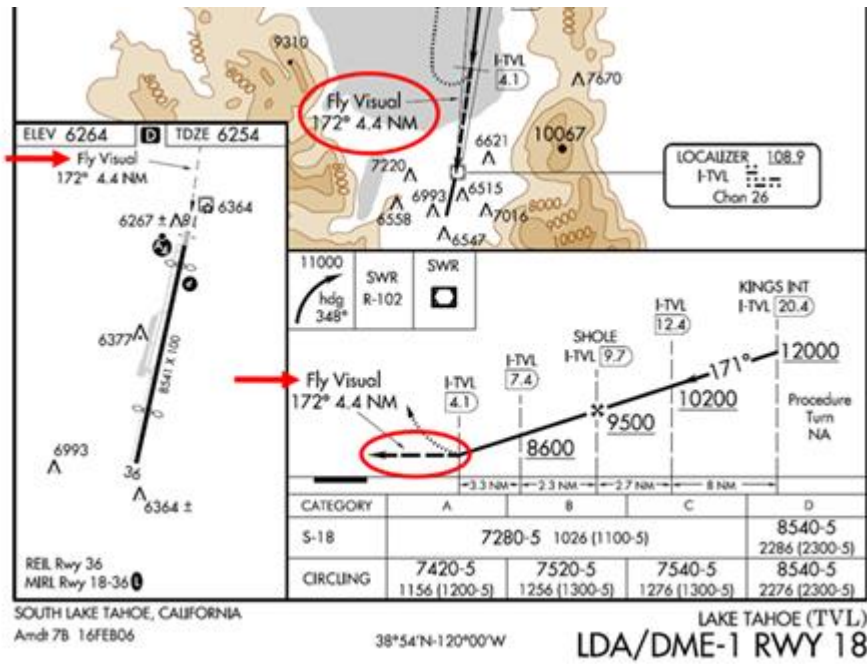
16.10.1. The depicted ground track associated with the visual segment should be flown as dead reckoning course. When executing the visual segment, remain clear of clouds and proceed to the airfield maintaining visual contact with the ground.

16.10.2. Altitude on the visual segment is at the discretion of the pilot, and it is the pilot’s responsibility for obstacle clearance.

16.10.3. Missed approach obstacle clearance is assured only if the missed approach is commenced at the published MAP. Before initiating an instrument procedure that contains a visual segment, the pilot should have preplanned climb out options based on aircraft performance and surrounding terrain. Obstacle clearance is the responsibility of the pilot when the approach is continued beyond the MAP.



Figure 16.10. Visual Segment.





Chapter 17

SPECIAL AIRCREW AND AIRCRAFT CERTIFICATION REQUIRED APPROACHES

**17.1. General.** Certain instrument procedures require specific aircraft certification and additional aircrew training and certification. MAJCOMs must provide training and operational approval for each individual procedure type listed in this chapter; training and approval for one procedure type does not extend to other procedure types (e.g., operational approval for CAT II procedures does not also authorize Special Authorization CAT I procedures). Aircrews may identify these instrument procedures by a chart **Note**:

- 17.1.1. "SPECIAL AIRCREW & AIRCRAFT CERTIFICATION REQUIRED", or
- 17.1.2. "AUTHORIZATION REQUIRED".

**17.2. Special Authorization Category I (SA CAT I).** [FAA Order 8400.13] Special Authorization CAT I allows a DH of 150 feet and RVR 1400 at runways with reduced lighting; a head-up display (HUD) must be used to DH (**Figure 17.1**). (**T-0**).

- 17.2.1. Single pilot operators are prohibited from using SA CAT I landing minimums. (**T-0**).
- 17.2.2. The runway has a landing distance of at least 5000 feet.
- 17.2.3. Required lighting and equipment: simplified short approach lighting system with runway alignment indicator lights (SSALR), medium intensity approach lighting system with runway alignment indicator lights (MALSR), approach lighting system with sequenced flashing lights (ALSF) -1, or ALSF-2; high intensity runway lighting (HIRL); and touchdown RVR sensor.

**Figure 17.1. SA CAT I ILS Approach.**



**17.3. Category II (CAT II).** [FAA Order 8400.13, AC 120-118] CAT II allows a DH of 100 feet and an RVR of 1200 feet; RVR may be reduced to 1000 feet with autoland or HUD to touchdown when noted on the procedure (**Figure 17.2**).

17.3.1. Required lighting: ALSF-2; HIRL; touchdown zone (TDZ) lighting; and runway centerline lights (RCL).

17.3.2. CAT II ILS operations require a touchdown RVR sensor. A rollout sensor is also required for CAT II operations below RVR 1600. When the runway is in excess of 8000 feet in length, a midpoint RVR sensor is required in addition to the touchdown and rollout sensors for CAT II operations below RVR 1600.

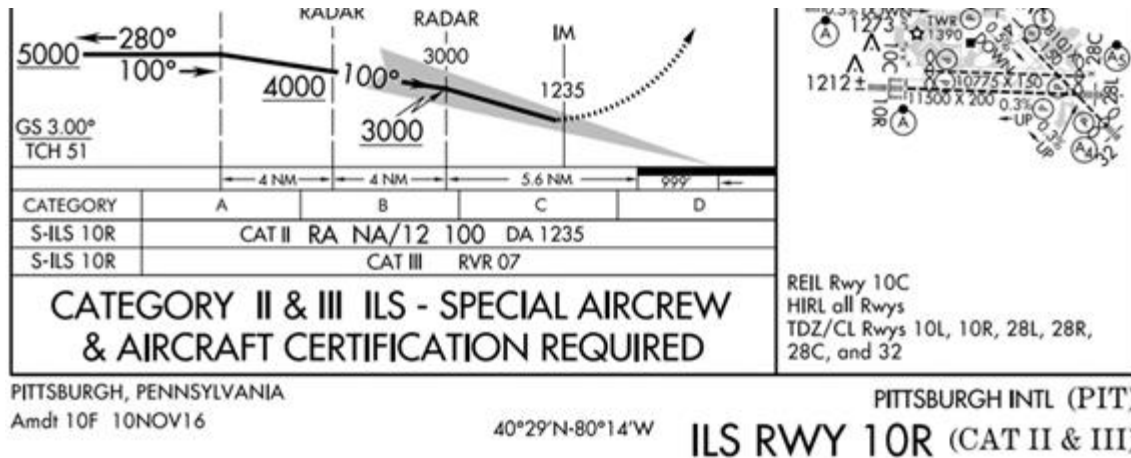
17.3.3. CAT II operations require an operational ATC tower; if the tower does not provide continuous service, operations are not authorized when the tower is closed.

17.3.4. “RA NA” is annotated in the CAT II line of minima when radio altimeter minimums are not authorized for a CAT II approach. Only the inner marker (IM) may be used to identify the DH due to terrain, obstacles, or other local requirements that preclude the use of radio altimeter minimums.

17.3.5. Only aircrew authorized for CAT II operations flying operationally certified CAT II aircraft may fly CAT II approaches.

17.3.6. Only aircrew authorized for CAT II operations flying aircraft operationally certified CAT III aircraft equipped with an operable autoland or HUD approved to touchdown capability may fly CAT II approaches to RVR 1000 minimums [FAA Order 8400.13, Chapter 6].

**Figure 17.2. CAT II ILS Approach.**



**17.4. “Copter” Category II.** [FAA Order 8900.1 Volume 4] Copter ILS CAT II allows a DH of 100 feet and an RVR of 1200 feet (Figure 17.3).

17.4.1. Unpublished DH reductions are not authorized.

17.4.2. The required visibility may not be reduced [14 CFR Part 97.3].

17.4.3. A marker beacon receiver with aural and visual indications of the IM or a functioning radio altimeter is required for Copter CAT II ILS operations with DH below 150 feet.

**Figure 17.3. COPTER CAT II ILS Approach.**

**17.5. Special Authorization Category II with Reduced Lighting (SA CAT II).** [FAA Order 8400.13] Special Authorization CAT II allows a DH of 100 feet and an RVR of 1200 feet; autoland or HUD must be used to touchdown (**Figure 17.4**). **(T-0)**.

17.5.1. SA CAT II approaches require a runway with landing distance of at least 6000 feet.

17.5.2. SA CAT II approaches require the following lighting: SSALR, MALSR (with threshold bar that is separate from runway end lights), ALSF-1, or ALSF-2; and HIRL.

17.5.2.1. CAT II and III operations (including SA CAT II) may continue if an installed ALSF-2 is operating as a SSALR or SALS, or MALSR is operating as a MALS [FAA Order 6750.24].

17.5.2.2. MAJCOMs may authorize SA CAT II aircrew to continue CAT II operations if the installed TDZ or RCLS fail [FAA Order 6750.24].

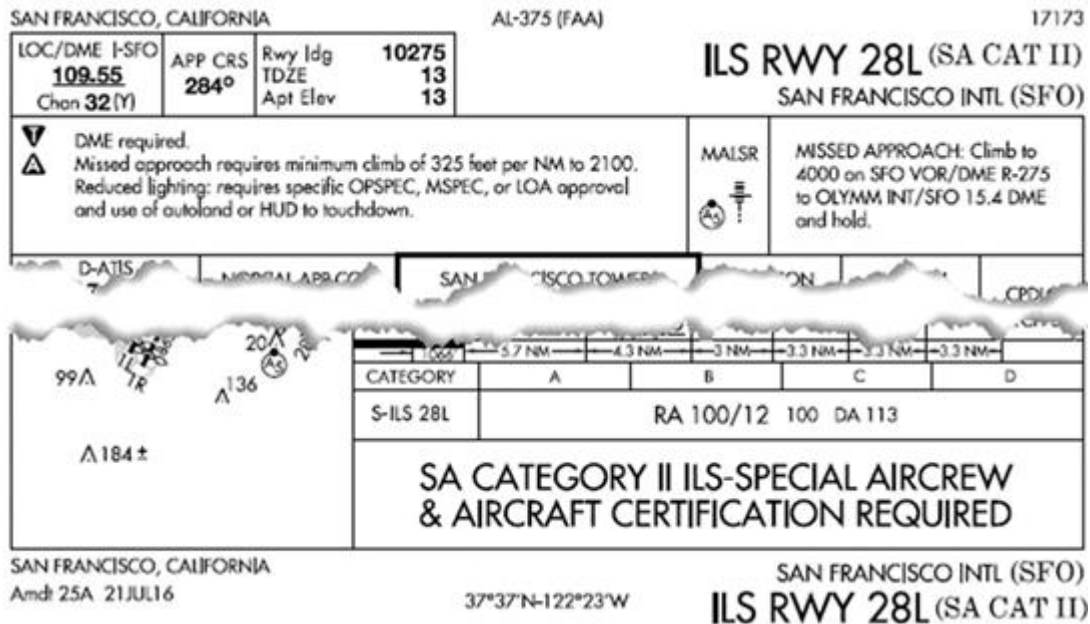
17.5.3. SA CAT II operations at RVR 1600 require a touchdown RVR sensor. **(T-0)**. SA CAT II operations at RVR 1200 require a minimum of two RVR sensors; one RVR sensor must be for the touchdown zone. **(T-0)**.

17.5.4. SA CAT II operations require an operational ATC tower; if the tower does not provide continuous service, operations are not authorized when the tower is closed. **(T-0)**.

17.5.5. "RA NA" is annotated in the SA CAT II line of minima when radio altimeter minimums are not authorized for a SA CAT II approach. Only the IM may be used to identify the DH due to terrain, obstacles, or other local requirements that preclude the use of radio altimeter minimums.

17.5.6. Only aircrew authorized for CAT II operations flying operationally certified CAT III aircraft equipped with an operable autoland or HUD approved to touchdown capability may fly SA CAT II approaches. **(T-0)**.

Figure 17.4. SA CAT II ILS Approach.



**17.6. Category III (CAT III).** [FAA Order 8400.13] CAT III operations allows a DH below 100 feet or no DH and a visibility of RVR 300 ([Figure 17.5](#)).

17.6.1. CAT III operations are separated into three subcategories [AIM 1-1-9]:

17.6.1.1. CAT IIIa does not have a DH or DH below 100 feet; RVR not less than 700 feet.

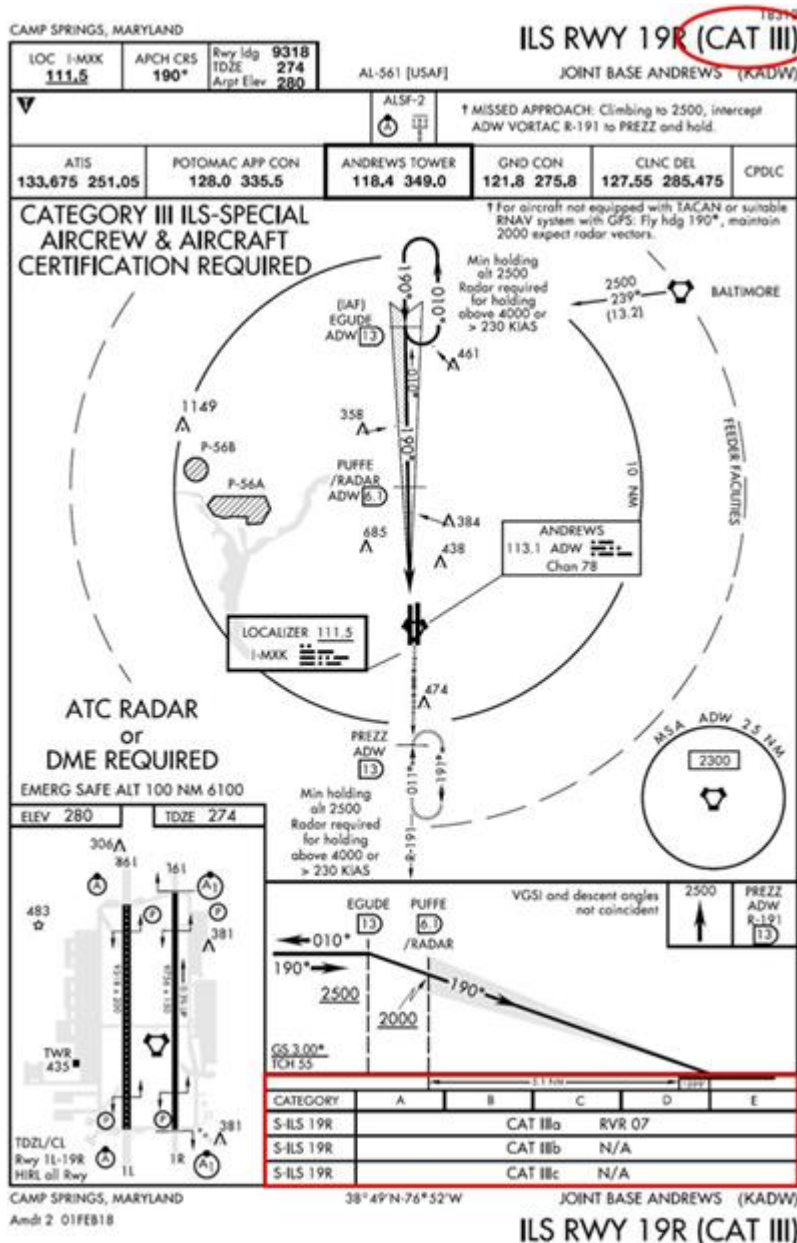
17.6.1.2. CAT IIIb does not have a DH or DH below 50 feet; RVR less than 700 feet but not less than 150 feet or (**NAS Only**) 300 feet.

17.6.1.3. CAT IIIc does not have a DH and no RVR limitation. CAT IIIc operations are currently not authorized [FAA Order 8900.1 Volume 4 Chapter 2].

17.6.1.4. Alert Height is 100 feet above the highest elevation in the touchdown zone, above which a CAT III approach would be discontinued and a missed approach initiated if a failure occurred in one of the required redundant operational systems in the airplane or in the relevant ground equipment. Below this height, the approach, flare, touchdown, and rollout may be safely accomplished following any individual failure in the associated CAT III systems.

17.6.2. Reference DH and Alert Height by AGL measured on the radar altimeter.

Figure 17.5. CAT III ILS Approach.



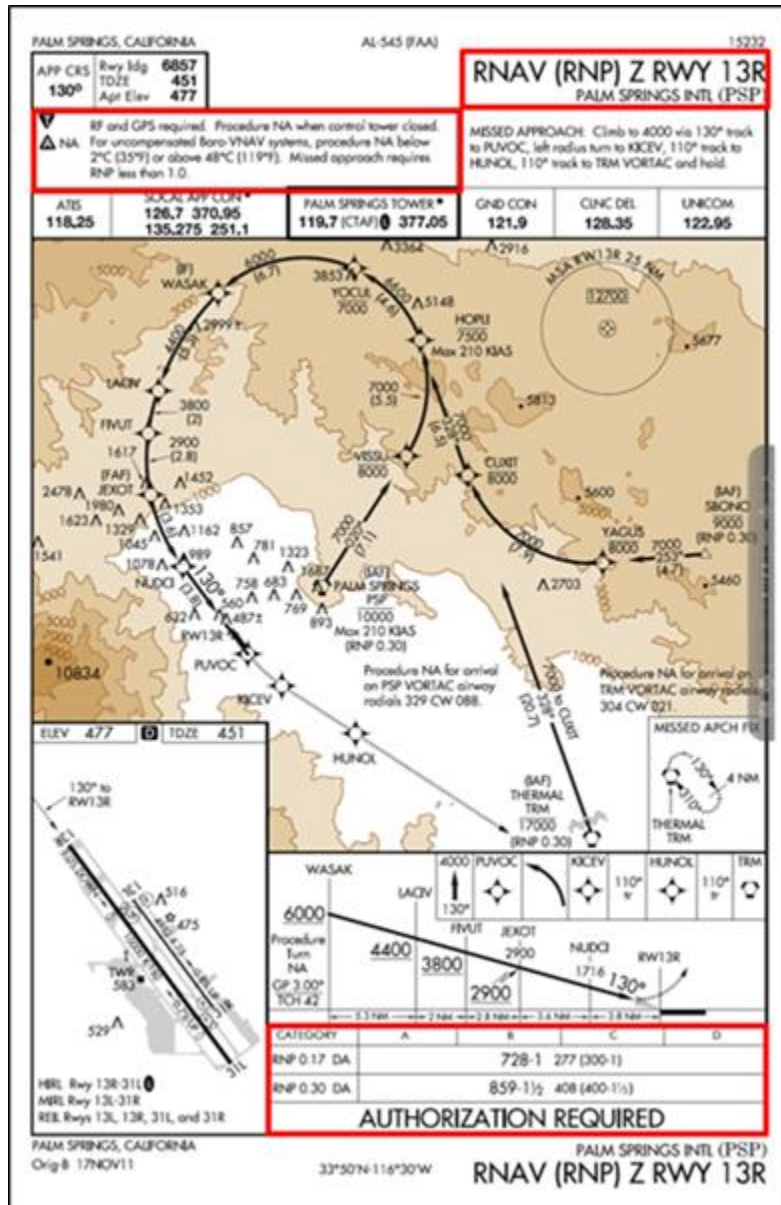
**17.7. Simultaneous Close Parallel ILS Precision Runway Monitor (PRM) / RNAV PRM / GLS PRM Approaches.** [AIM 5-4-16] The term “PRM” alerts pilots that specific airborne equipment, training, and procedures are required for the approach. MAJCOM training and certification is required prior to participation in ILS PRM, RNAV PRM, or GLS PRM approaches. (T-0).

**17.8. Simultaneous Offset Instrument Approaches (SOIA).** [AIM 5-4-16] The SOIA procedure utilizes an ILS PRM approach to one runway and an offset LDA PRM approach with glideslope to the adjacent runway. MAJCOM training and certification is required prior to participation in SOIA. (T-0).



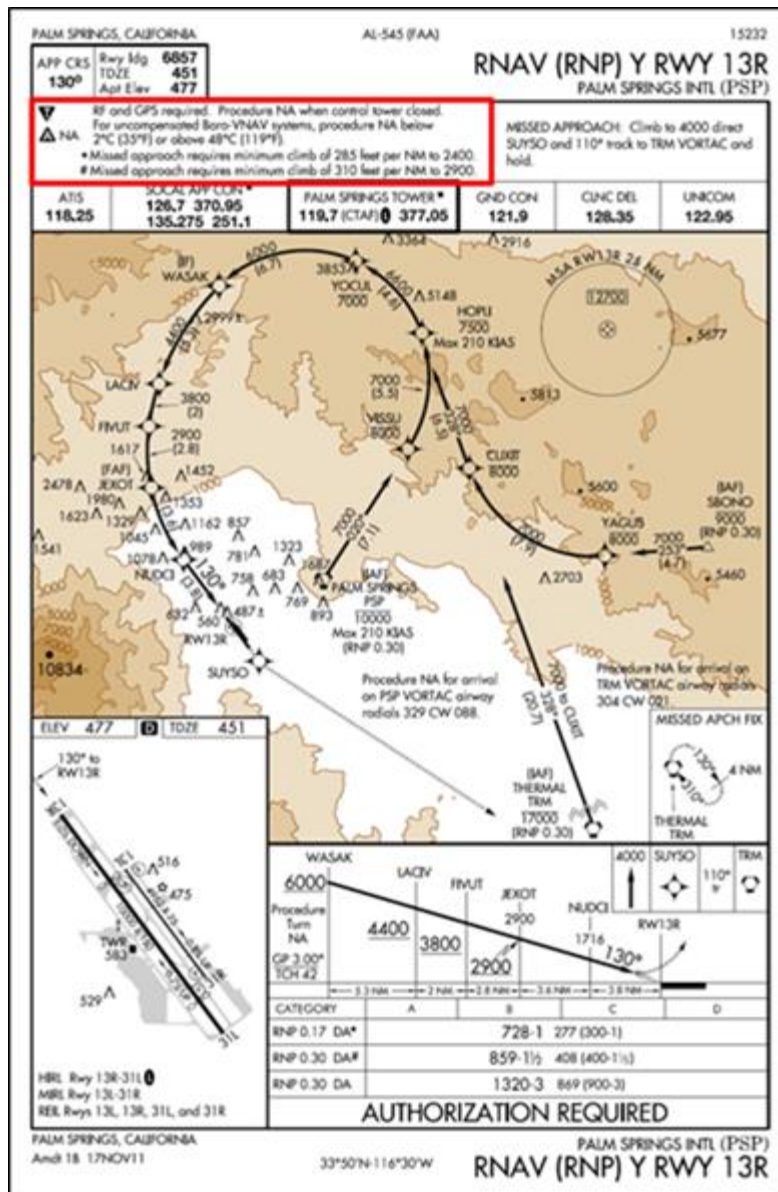
**17.9. RNP Authorization Required (AR) Approach Procedures.** [AC 90-101; AIM 5-4-18] Each published line of minima has an associated RNP value defining the lateral and vertical performance requirements. A minimum RNP type is documented as part of the RNP AR authorization and may vary depending on aircraft configuration or operational procedures (e.g., GPS inoperative, use of flight director vice autopilot). Procedures may require RF capability or missed approach instructions with RNP values less than 1.0. (Figure 17.6)

**Figure 17.6. RNP Values.**



17.9.1. RNP AR approaches are developed based on standard approach speeds and a 200 foot per nautical mile climb gradient in the missed approach. Any exceptions to these standards are indicated on the approach procedure (Figure 17.7).

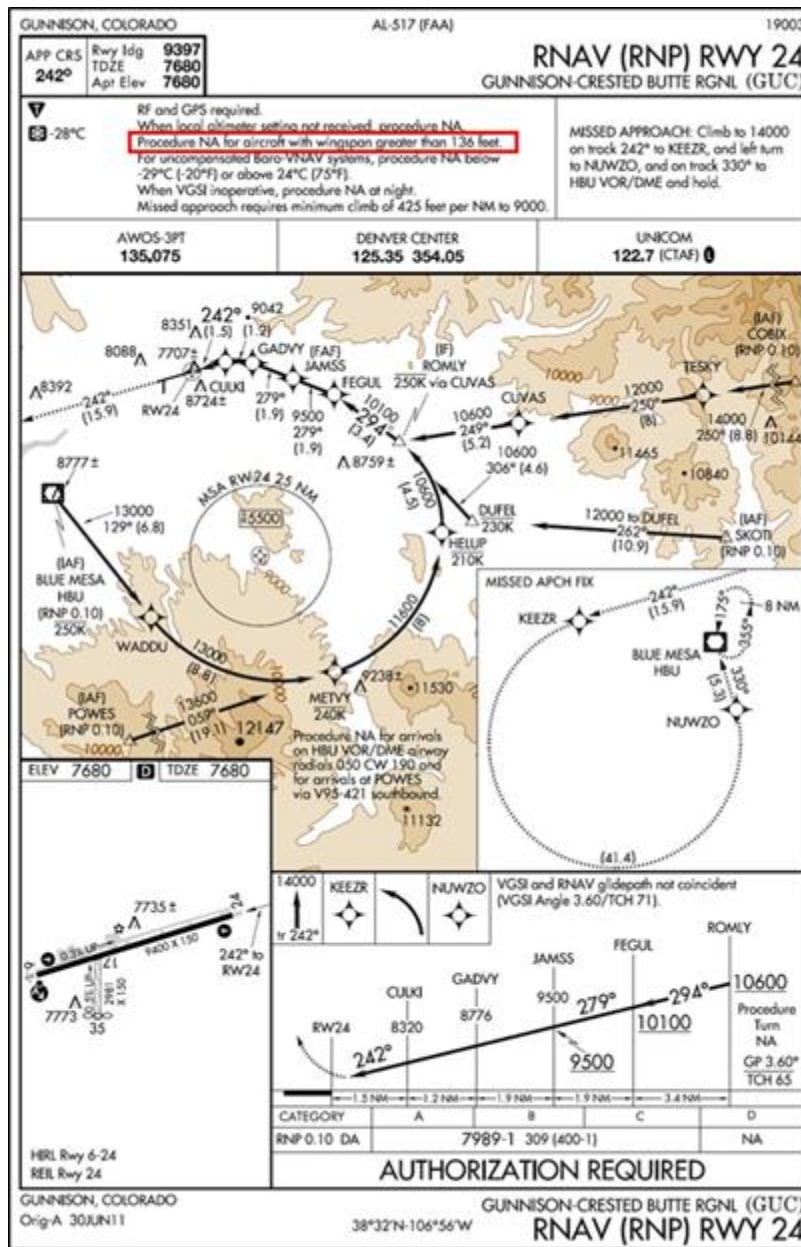
Figure 17.7. Nonstandard Missed Approach Climb Gradient.



17.9.2. RNP AR approach minimums may be dependent on aircraft size (Figure 17.8). Large aircraft may require higher minimums due to gear height or wingspan. Approach procedure charts are annotated with applicable aircraft size restrictions.

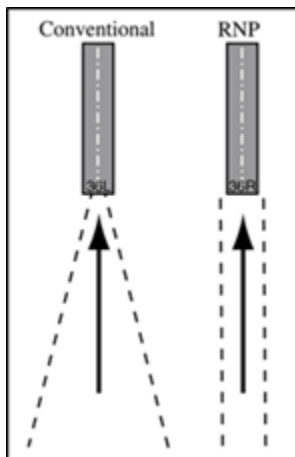


Figure 17.8. Aircraft Size Restrictions.

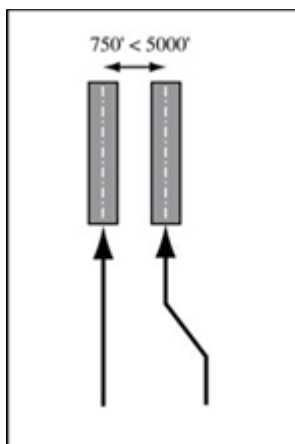


17.9.3. RNP stand-alone approach operations provide access to runways regardless of the ground-based NAVAID infrastructure and designed to avoid obstacles, terrain, airspace, or resolve environmental constraints.

17.9.4. RNP parallel approach operations may be used for parallel approaches where the runway separation is adequate (Figure 17.9). Parallel approach procedures may be used either simultaneously or as stand-alone operations. They may be part of either independent or dependent operations based on ATC’s ability to provide radar monitoring.

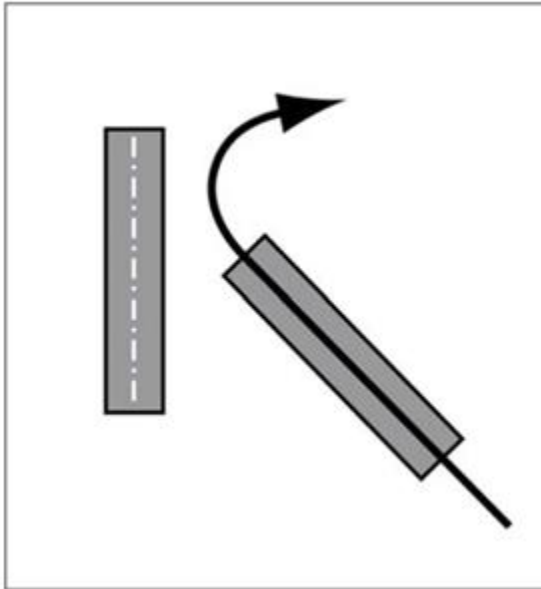
**Figure 17.9. RNP Parallel Approach Operations.**

17.9.5. RNP parallel approach runway transition approaches begin as a parallel IFR approach operation using simultaneous runway procedures (Figure 17.10). Visual separation standards are used after the FAF to permit aircraft to transition in visual conditions along a predefined lateral and vertical path to align with the runway centerline.

**Figure 17.10. RNP Parallel Approach Runway Transition Operations.**

17.9.6. RNP converging runway operations provide a precise curved missed approach path that conforms to aircraft separation minimums for simultaneous operations at airfields where runways converge (Figure 17.11). Dual runway operations may continue to lower ceiling and visibility values than currently available by flying the curved RNP missed approach path.

**Figure 17.11. RNP Converging Runway Operations.**



## Chapter 18

### LANDING

**18.1. General.** The transition from instrument to visual flight conditions varies with each approach. Pilots seldom experience a distinct transition from instrument to visual conditions during an approach in obscured weather.

**18.2. Land and Hold Short Operations (LAHSO).** [FAA Order 7110.118A] The PIC is the final authority whether to take-off, land, or continue a touch-and-go when LAHSO is in effect. The PIC may not accept a LAHSO clearance without MAJCOM training. **(T-1). Exception:** PIC may passively participate in LAHSO (land or takeoff when another aircraft has been given a LAHSO clearance).

**18.3. Reduced Same Runway Separation (RSRS).** MAJCOMs may approve non-formation RSRS operations. Host ATC and user units will publish RSRS procedures. **(T-2).** MAJCOM approval shall include MDS-specific RSRS criteria governing similar and dissimilar landing, touch-and-go or low approach operations.

**18.3. (AFMC) Reduced Same Runway Separation.** The FOA may authorize RSRS operations. If authorized, comply with the minimum criteria established by AFMC/A3O. If implemented, procedures must be published in the local flying (11-series) directives/supplements. **(T-2).**

**18.4. Helicopter Landing Areas.** Helicopters may operate to and from other than established landing areas (e.g., fields, highways, parks) if conducting an operational or training mission. For training missions, permission must be received to use the area and safeguards must exist to permit operations without hazard to persons or property. **(T-3).**

**18.5. Landing With Hot Armament.** MAJCOMs will publish procedures for aircraft operations with hot armament.

**18.5. (AFMC) Landing with Hot Armament.** Units that conduct operations with live armament will publish procedures for live/hung ordnance in the unit supplement to AFMAN 11-2FTV3, local airfield operations instructions, and in-flight guide. **(T-2).**

**18.6. Touch-and-Go Landings.** MAJCOMs will publish guidance addressing operating conditions and qualifications.

**18.6. (AFMC) Touch-and-Go Landings.** Touch-and-go landings are authorized provided requirements of AFMAN 11-2FTV3 and AFMAN 11-2FTV1 are met.

**18.7. Turns after Touch-and-Go or Low Approach.** The minimum turn altitude after takeoff is 400 feet above the DER elevation, unless required by a published procedure or ATC. **(T-0). Exception:** The PIC may turn at a safe altitude when executing closed patterns.

**18.8. Traffic Pattern.** [14 CFR 91.126, ICAO Annex 2] Fly traffic patterns in accordance with control tower instructions, local flying procedures, or FLIP. **(T-1).**

18.8.1. At non-towered airports or part-time-towered airports when the control tower is not operating, pilots should make all turns to the left unless the airport displays approved light signals, visual markings, or FLIP indicates right turns. **Note:** This includes circling approaches to a left base, unless the approach procedure explicitly states otherwise.

18.8.2. [Helicopter only] Avoid the flow of fixed-wing aircraft unless operating at a compatible airspeed.

**18.9. Illusions and Vision in Flight.** [AIM 8-1-5; AIM 8-1-6] There are many phenomena, such as rain, smoke, snow, and haze, which may restrict visibility. Knowledge of these various factors aids in making a safe, smooth transition from instrument to visual flight. Refer to AFH 11-203V1 for a detailed description of weather conditions.

18.9.1. Approach lights, runway markings, runway lights, and contrasts are the primary sources of visual cues. Become familiar with the lighting and marking patterns at the destination and correlate them with the weather to prepare for the transition to visual flight. In minimum visibility conditions, the visual cues and references for flare and runway alignment are extremely limited compared to the normal references used during a visual approach. Therefore, the aircraft's projected runway contact point may not be visible until considerably below published minimums.

18.9.2. When flying a straight-in approach in VMC, the pilot has almost unlimited peripheral visual cues available for depth perception, vertical positioning, and motion sensing. Even so, varying length and width of unfamiliar runways can lead to erroneous perception of aircraft height above the runway surface. A relatively wide runway may give the illusion that the aircraft is below a normal glidepath; conversely, a relatively narrow runway may give the illusion of being high. With an awareness of these illusions under unlimited visibility conditions, it becomes easy to appreciate a pilot's challenges in a landing situation in which the approach lights and runway lights are the only visual cues available.

18.9.3. Instrument approach lights do not provide adequate vertical guidance to the pilot during low visibility instrument approaches. Available visual cues may not allow the pilot to adequately determine vertical position or vertical motion.

18.9.3.1. Studies have shown that the sudden appearance of runway lights when the aircraft is at or near minimums in conditions of limited visibility often gives the pilot the illusion of being high. They have also shown that when the approach lights become visible, pilots tend to abandon the established glidepath, ignore flight instruments, and instead rely on the poor visual cues.

18.9.3.2. When flying into ground fog from above, if the pilot initially sees the runway or approach lights, these cues tend to disappear entering the fog bank. The loss of these visual cues can induce the illusion or sensation of climbing. Limited visual cues can cause the illusion that the aircraft is above normal glidepath and potentially result in a pushover reaction (i.e., "duck-under"), an increased rate of descent, and a short or hard landing.

18.9.4. In limited visibility, approach lights may not be seen until the aircraft is close to the ground which may delay the normal transition to landing. The delay in reducing the descent rate when the aircraft is very close to the ground may create a situation in which sufficient lift cannot be generated to break the rate of descent when the pilot realizes the aircraft is going to land short.

18.9.4.1. A method to prevent a high rate of descent and a short or hard landing is to maintain composite cross-check using external visual cues, the glideslope indicator or flight director, VVI, and attitude indicator (AI) indications.

18.9.4.2. Another potential duck-under situation occurs when the pilot attempts to land within the first 500 to 1,000 feet of the runway after breaking out of an overcast condition. In this case, the pilot may attempt to establish a visual profile similar to the one used most often. Establishing the visual profile usually involves reducing power and changing attitude to aim the aircraft at some spot short of the end of the runway. High sink rates and poor thrust/lift relationships can develop quickly which may cause undershoots or hard landings. Landing decisions should be based upon the normal touchdown point from the instrument approach. If stopping distances are in doubt, proceed to an alternate.

18.9.4.3. At 100-foot elevation and a 3 degrees glideslope, an aircraft is approximately 1,900 feet from the runway point of intercept. If the aircraft's final approach speed is 130 knots (215 feet per second), the pilot has about 9 seconds to bring visual cues into the cross-check, ascertain lateral and vertical position, determine a visual flight path, and establish appropriate corrections. More than likely, 3 to 4 seconds is spent integrating visual cues before making a necessary control input. By this time, the aircraft is 600 to 800 feet closer to the runway point of intercept, 40 to 60 feet lower, and possibly well into the flare. Therefore, it is essential to be prepared to use visual cues properly and with discretion during the final stages of a low visibility approach. Prior to total reliance on visual information, confirm that the instrument indications support the visual perspective.

**18.10. Approach Lighting Systems (ALS).** [FLIP FIH] Approach lighting systems are visual aids used during instrument conditions to supplement the guidance information of electronic aids such as VOR, TACAN, PAR, and ILS. The approach lights are designated high intensity (the basic type of installation) or medium intensity. Most runway and approach light systems allow the tower controller to adjust the lamp brightness for different visibility conditions, or at a pilot's request. The extreme brilliance of high intensity lights penetrates fog, smoke, precipitation, etc., but may cause excessive glare under some conditions. The approach lighting systems currently in use appear in the FIH.

**18.11. Runway Lighting Systems.** [AFMAN 11-218] Basic runway lighting systems are used to aid the pilot in defining the usable landing area of the runway. These are runway edge lighting system, runway centerline lighting system and touchdown zone lights.

**18.12. Runway Markings.** [AFMAN 11-218] Runway markings are designed to make the landing area more conspicuous and to add a third dimension for night and low visibility operations.

**18.13. Circling Approaches.** [AIM 5-4-20; ICAO Doc 8168 Volume 1] Visual maneuvering (i.e., "circling") is the term used to describe the phase of flight after an instrument approach has been completed. It brings the aircraft into position for landing on a runway which is not suitably located for straight-in approach (i.e., one where the criteria for alignment or descent gradient cannot be met). A circling approach is a visual flight maneuver conducted under IFR. Each circling situation is different due to variables such as runway layout, final approach track, wind velocity, and meteorological conditions.

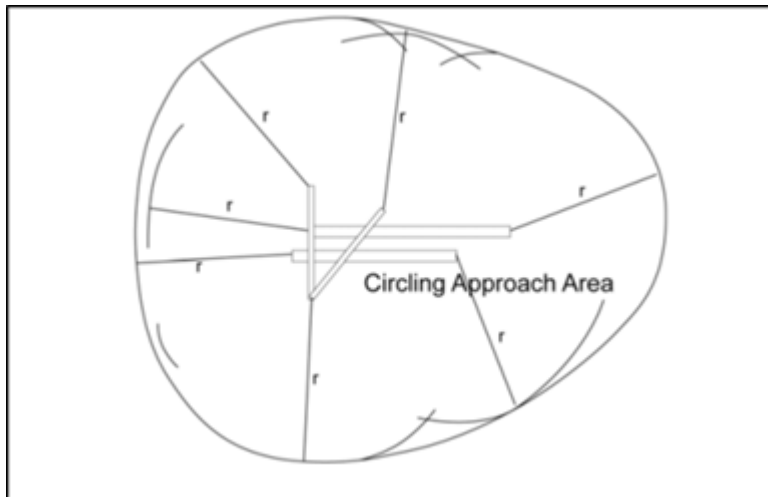
18.13.1. Pilots will not circle from a GLS, an ILS without a localizer line of minima, or an RNAV (GPS) approach without an LNAV line of minima. **(T-0)**. Pilots will not circle from an approach without a published circling line of minima. **(T-0)**.

18.13.2. State the aircraft category when requesting circling MDA from the controller prior to circling from an airport surveillance radar (ASR) approach.

18.13.3. The circling minima listed on instrument procedures apply to all approach types on the instrument procedure (e.g., ILS or LOC, VOR or TACAN). If planning to circle from an approach with vertical guidance, pilots must ensure the aircraft is within the appropriate circling radius for the aircraft category and above the circling MDA before abandoning the precision glideslope. **(T-0)**.

**18.14. Circling Protected Area.** [AIM 5-4-20; ICAO Doc 8168 Volume 2] Circling approach protected areas are defined by the tangential connection of arcs drawn from each runway end as shown in **Figure 18.1**. Obstruction clearance areas (i.e., “protected airspace”) are determined by aircraft category. If it is necessary to maneuver at speeds in excess of the upper limit of the speed range authorized, use the landing minima for the category appropriate to the maneuvering speed. Pilots must ensure they remain within the required obstacle clearance radius and maintain situational awareness. **(T-0)**. If there is any doubt, accomplish the missed approach.

**Figure 18.1. Circling Approach Area.**



18.14.1. **[NAS Only]** Prior to late 2012, circling approach protected areas used fixed-radius distances, dependent on aircraft category, as shown in **Table 18.1**. These approaches can be identified by the absence of the “negative C” symbol on the circling line of minima.

**Table 18.1. US TERPS Standard Circling Criteria.**

| Circling MDA (feet MSL)                      | CAT A | CAT B | CAT C | CAT D | CAT E |
|--|-------|-------|-------|-------|-------|
| All Altitudes                                | 1.3   | 1.5   | 1.7   | 2.3   | 4.5   |
| <b>Note:</b> Distances are in nautical miles |       |       |       |       |       |

18.14.2. After 2012, TERPS procedure designers began designing circling approach protected areas based on a radius distance dependent on the aircraft category and the altitude of the circling MDA, which accounts for the true airspeed increase with altitude. The approaches utilizing the expanded circling approach areas can be identified by the presence of the “negative C” symbol on the circling line of minima (**Figure 18.2** and **Table 18.2**).



Figure 18.2. Expanded Circling Area Annotation.

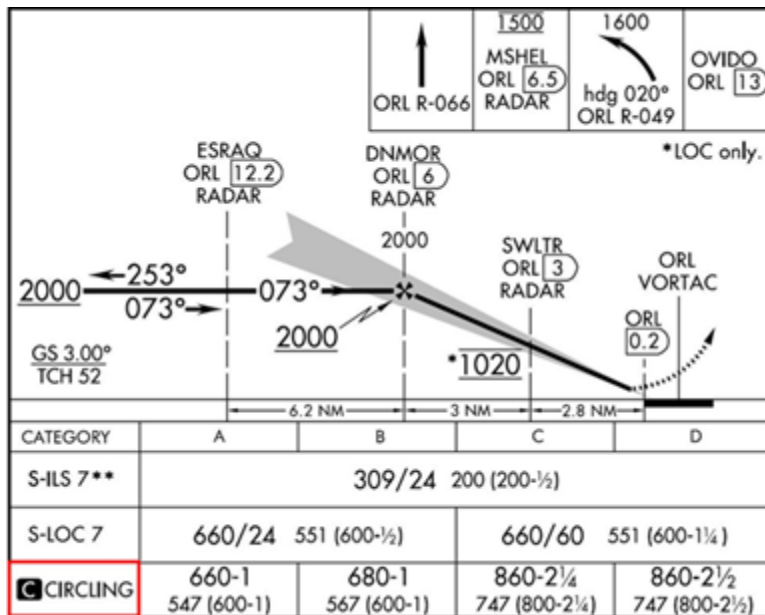


Table 18.2. US TERPS Expanded Circling Approach Maneuvering Airspace.

| Circling MDA (feet MSL) | CAT A | CAT B | CAT C | CAT D | CAT E |
|-------------------------|-------|-------|-------|-------|-------|
| 1000 or less            | 1.3   | 1.7   | 2.7   | 3.6   | 4.5   |
| 1001 – 3000             | 1.3   | 1.8   | 2.8   | 3.7   | 4.6   |
| 3001 – 5000             | 1.3   | 1.8   | 2.9   | 3.8   | 4.8   |
| 5001 – 7000             | 1.3   | 1.9   | 3.0   | 4.0   | 5.3   |
| 7001 – 9000             | 1.4   | 2.0   | 3.2   | 4.2   | 5.3   |
| 9001 and above          | 1.4   | 2.1   | 3.3   | 4.4   | 5.5   |

**Note:** Distances are in nautical miles

18.14.3. [ICAO] Circling area radii are in accordance with [Table 18.3](#) ICAO circling bank angle is 20 degrees average achieved or 3 degrees per second, whichever requires less bank.

**Table 18.3. PANS-OPS Circling Area Radii.**

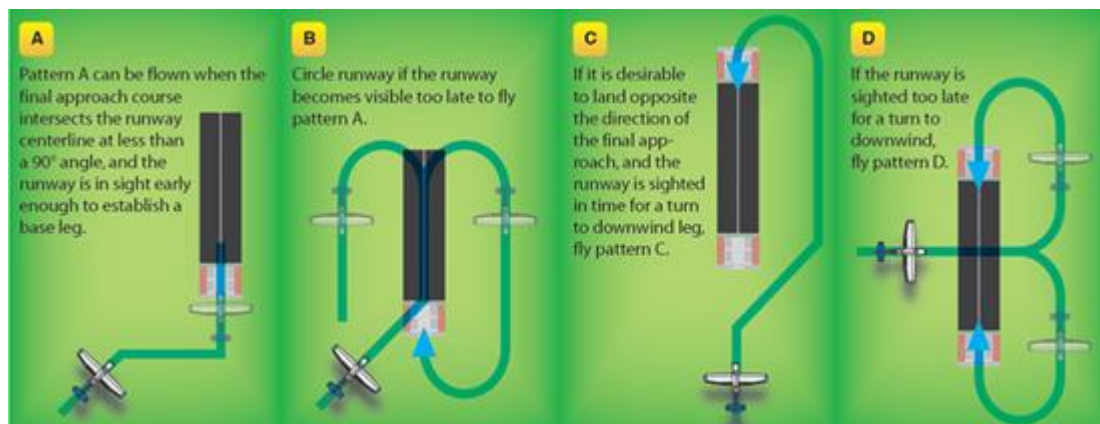
|                                | CAT A  | CAT B | CAT C                 | CAT D | CAT E                 |
|--------------------------------|--|-------|-----------------------|-------|-----------------------|
| <b>Maximum Speed (KIAS)</b>    | 100  | 135   | 180                   | 205   | 240                   |
| <b>Obstruction Clearance</b>   | 90 meters (295 feet)                         |       | 120 meters (394 feet) |       | 150 meters (492 feet) |
| <b>Circling MDA (feet MSL)</b> | <b>Circling Area Radii in Nautical Miles</b> |       |                       |       |                       |
| 1000 or less                   | 1.6  | 2.5   | 4.1                   | 5.1   | 6.7                   |
| 1001 – 3000                    | 1.6  | 2.6   | 4.2                   | 5.2   | 6.9                   |
| 3001 – 5000                    | 1.7  | 2.7   | 4.3                   | 5.4   | 7.0                   |
| 5001 – 7000                    | 1.7  | 2.8   | 4.5                   | 5.6   | 7.4                   |
| 7001 – 9000                    | 1.8  | 2.9   | 4.7                   | 5.9   | 7.8                   |
| 9001 and above                 | 1.9  | 3.1   | 4.9                   | 6.2   | 8.2                   |

18.14.4. There is no secondary obstacle clearance area for circling maneuvers. Certain sectors may be excluded from consideration where prominent obstacles exist. In this case, a note is provided excluding this sector from use during the circling maneuver.

18.14.5. The maximum speed for circling is in accordance with **Table 18.3 (NAS Only)**. The maximum speed for circling is the aircraft category speed for the instrument procedure flown.

18.14.6. If the controller has a requirement to specify the direction of the circling maneuver in relation to the airfield or runway, the controller issues instructions in the following manner: “Circle west of the airport for a right base to runway one eight.” ATC should not issue clearances such as “extend downwind leg” that take the aircraft out of the protected area.

18.14.7. There may be situations when a circling approach is required but no ceiling is published. In this case, the required ceiling is the HAA plus 100 feet and rounded up to the next one hundred foot value. For example, if the HAA is 757 feet, add 100 feet to get 857 feet and then round up to the nearest one hundred foot value, which would be 900 feet.

**Figure 18.3. Circling Maneuver Examples.**

**18.15. Accomplishing the Circling Maneuver.** Maneuver the shortest path to the base or downwind leg, as appropriate, considering existing weather conditions ([Figure 18.3](#)). There is no restriction from passing over the airfield or other runways.

18.15.1. Make either left or right turns to final unless directed by the controlling agency to turn in a specific direction or limited by published restrictions. Circling maneuvers may be made while VFR or other flying operations are in progress at the airfield.

18.15.2. At non-towered airfields consider over flying the airfield to observe current wind and other traffic which may be on the runway or flying near the airfield.

18.15.3. Do not descend below circling MDA until the pilot is able to place the aircraft on a normal glidepath to the landing runway and execute a safe landing. The common tendency is to maneuver too close to the runway at altitudes lower than normal VFR pattern altitude due to using the same visual cues as normal VFR pattern altitudes. Select a pattern that displaces the aircraft far enough from the runway for a turn to final without overbanking or overshooting.

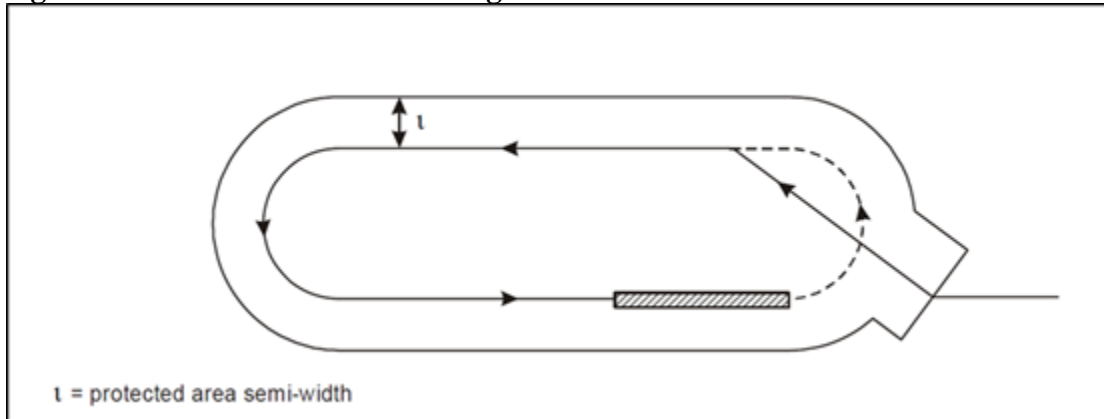
**18.16. [ICAO] Visual Maneuver Using a Prescribed Track.** [ICAO Doc 8168 Volume 1, Part 4, Section 7] An ICAO State may prescribe a specific track for visual maneuvering in addition to the circling area in those locations where clearly defined visual features permit and if it is operationally desirable. Flight crews need to be familiar with the terrain and visual cues to be used for this procedure. **Note:** Navigation is primarily by visual reference and any radio navigation information presented is advisory only and the missed approach for the normal instrument procedures applies.

18.16.1. The direction and length of each segment are defined, if a speed restriction is prescribed, it is published on the chart. The length of the final segment is based on an allowance of 30 seconds of flight before the threshold. When a minimum altitude or height is specified at the beginning of a segment, the length of the final segment is adjusted, if necessary considering the descent gradient or angle.

18.16.2. The protected area is based on a corridor with a constant width, centered on the nominal track. The corridor starts at the “divergence” point and follows the track, including a go-around for a second visual maneuvering with prescribed track ([Table 18.4](#) and [Figure 18.4](#)).

**Table 18.4. Semi-Width of the Corridor.**

| Semi-Width of the Corridor | Aircraft Category |       |       |       |       |
|----------------------------|-------------------|-------|-------|-------|-------|
|                            | A                 | B     | C     | D     | E     |
| Meters                     | 1,400             | 1,500 | 1,800 | 2,100 | 2,600 |
| Feet                       | 4,593             | 4,921 | 5,905 | 6,890 | 8,530 |

**Figure 18.4. Visual Maneuver Using a Prescribed Track Protected Area.**

**18.17. Side-Step Maneuver.** [AIM 5-4-19] ATC may authorize an instrument procedure which serves either one of parallel runways that are separated by 1,200 feet or less, followed by a straight-in landing on the adjacent runway where side-step minimums are published (**Figure 18.5**). Aircraft executing a side-step maneuver are cleared for a specified non-precision approach and landing on the adjacent parallel runway. For example “Cleared ILS runway seven left approach, side-step to runway seven right.”

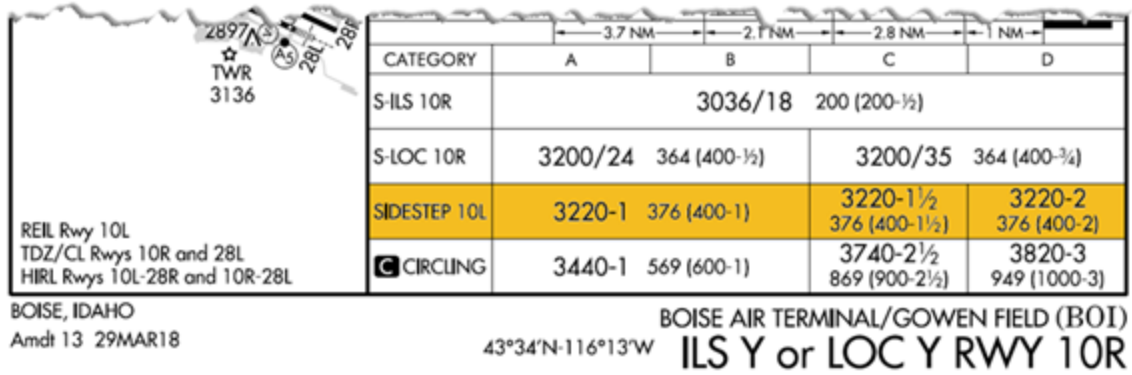
18.17.1. Pilots will not side-step without a published sidestep line of minima. **(T-0)**.

18.17.2. Pilots are expected to commence the side-step maneuver as soon as possible after the runway or runway environment is in sight. Typically this occurs inside the FAF.

18.17.3. Side-step minimums are flown to a MDA regardless of the approach authorized.

18.17.4. Follow the missed approach specified for the approach procedure just flown unless otherwise directed by ATC if visual reference is lost during the maneuver. An initial climbing turn toward the landing runway ensures that the aircraft remains within the obstruction clearance area.

Figure 18.5. Published Side-Step Minimums.



## Chapter 19

### MISSED APPROACH

**19.1. General.** When a landing cannot be accomplished, advise ATC. Upon reaching the missed approach point, the pilot must comply with the missed approach instructions for the procedure being used unless an alternate missed approach procedure is specified by ATC. References for this chapter are 14 CFR 91.175, AIM 5-4-21 and 5-5-5, FAA-H-8083-16 Chapter 4, ICAO Doc 8168 Volume 1 Part 1 Section 4 Chapter 6, unless otherwise noted.

**19.2. Missed Approach.** Fly the missed approach instructions for the procedure being flown or ATC-assigned alternate missed approach instructions. **(T-0).** The PIC must ensure that the aircraft has climbed to a safe altitude prior to proceeding off the published missed approach. **(T-0).**

19.2.1. When the missed approach is initiated prior to the MAP, the pilot will, unless otherwise cleared by ATC, fly the instrument procedure as specified on the approach plate, including altitude restrictions, to the MAP at or above the MDA, DA, or DH before executing the missed approach instructions. **(T-0).**

19.2.2. Any turns on the missed approach will not begin until the aircraft reaches the MAP; likewise, if the aircraft reaches the MAP before descending to the MDA, the missed approach will be initiated at the MAP. **(T-0).**

19.2.3. Ensure the aircraft can meet or exceed 200 feet per nautical mile or the published climb gradient, whichever is higher, to an appropriate IFR altitude whichever ensures obstacle clearance with all engines operating. **(T-1).** **Note:** or meet 400 feet per nautical mile for “Copter Only” approaches **(T-0).**

**19.3. ICAO Bank Angle.** [ICAO Doc 8168 Volume 1, Table I-2-3-1] ICAO missed approach bank angle is 15 degrees average achieved or 3 degrees per second, whichever requires lesser bank.

**19.4. Missed Approach Instructions.** A clearance for an approach includes a clearance to fly the published missed approach on the instrument procedure, unless otherwise instructed by ATC.

19.4.1. Pilots must comply with the missed approach instructions for the procedure being flown or ATC-issued alternate missed approach instructions. **(T-0).**

19.4.2. Pilots must ensure that they have climbed to a safe altitude prior to proceeding off the published missed approach. **(T-0).**

19.4.3. Abandoning the missed approach procedure prior to reaching the published altitude may not provide adequate terrain clearance. An additional climb may be required after reaching the holding pattern before proceeding back to the IAF or to an alternate.

**19.5. ATC Notification.** [AIM 5-4-7] When executing a missed approach (i.e., when cleared to land and subsequently execute a missed approach or upon reaching the MAP and unable to continue) the pilot will notify ATC as soon as possible. **(T-0).** Request follow-on action clearance as time permits (e.g., clearance to an alternate airfield, another approach, or holding).

**19.6. Missed Approach Airspeed.** Comply with any published speed restrictions on the instrument procedure. The maximum ICAO missed approach speeds are shown in **Table 19.1** [ICAO Doc 8168 Volume 1].

**Table 19.1. ICAO Maximum Missed Approach Speed.**

| <b>Aircraft Category</b>  | <b>Maximum Speed for MAP (knots) Intermediate</b> | <b>Maximum Speed for MAP (knots) Final</b> |
|---|---|--|
| A <sup>1,2</sup>  | 100   | 110  |
| B   | 130   | 150  |
| C   | 160   | 240  |
| D   | 185   | 265  |
| E   | 230   | 275  |
| H <sup>3</sup>  | 90  | 90   |
| CAT H (PinS)  | 70 or 90  | 70 or 90                                   |
| CAT H (PinS) procedures based on basic GNSS may be designed using maximum speeds of 90 KIAS or 70 KIAS depending on operational need.   |   |  |
| <b>Notes:</b>   |   |  |
| 1) The minimum final approach speed considered for a CAT A aircraft is 70 knots. This is only critical when the missed approach point is specified by a distance from the FAF. In these cases, a slower speed when combined with a tailwind may cause the helicopter to reach the start of climb after the point calculated for CAT A aircraft. This reduces the obstacle clearance in the missed approach phase. |   |  |
| 2) Conversely, a slower speed combined with a headwind could cause the helicopter to reach the missed approach point and any subsequent turn altitude before the point calculated for CAT A aircraft, and hence depart outside the protected area.  |   |  |
| 3) Therefore, for helicopters, speed should be reduced below 70 knots only after the visual references necessary for landing have been acquired and the decision has been made that an instrument missed approach procedure will not be departed.   |   |  |

**19.7. Missed Approach Phases.** [ICAO Doc 8168 Volume 2].

19.7.1. The initial phase begins at the MAP and ends at the start of climb. This phase requires concentrated attention of the pilot on establishing the climb and the changes in airplane configuration. It is assumed that guidance equipment is not extensively utilized and no turns are specified in this phase.

19.7.2. The intermediate phase extends from the start of climb. The climb is continued, normally straight ahead. It extends to the point where 50 meters (164 feet) (Cat H, 40 m (132 feet)) obstacle clearance is obtained and can be maintained. The intermediate missed approach track may be changed from the initial phase by a maximum of 15 degrees. During this phase it is assumed that the aircraft begins track corrections.

19.7.3. The final phase begins at the point where 50 meters (164 feet) (Cat H, 40 m (132 feet)) obstacle clearance is first obtained and can be maintained. It extends to the point where a new approach, holding, or a return to enroute flight is initiated. Turns may be prescribed in this phase.

**19.8. Turning Missed Approach.** [ICAO Doc 8168 Volume 1, Part 1, Section 4, Chapter 6] Turns in a missed approach procedure are only prescribed where terrain or other factors make a turn necessary.



**19.9. RNAV Missed Approach.** The missed approach waypoint for RNAV approaches without vertical guidance (i.e., LP and LNAV), is normally the runway threshold but may be located prior to the threshold, on or off runway centerline. RNAV approaches with vertical guidance (i.e., LPV and LNAV/VNAV) and GLS approaches utilize a DA.

19.9.1. RNAV missed approach procedures are RNAV 1 or RNP 1.

19.9.2. There are no RNP requirements for the missed approach if it is based on conventional means (e.g., VOR, DME, NDB, or dead reckoning).

19.9.3. RNAV missed approach holding waypoints are fly-over waypoints. If these waypoints are dual-use (i.e., the named waypoint has a different attribute on another procedure or enroute chart), see [paragraph 10.4.2](#).

19.9.4. [ICAO Doc 9613; AC 90-105] The flight guidance mode should remain in LNAV when initiating a go-around or missed approach to enable display of deviation and positive course guidance during a missed approach RF leg. If the aircraft does not provide this capability, crew procedures must be used that assure the aircraft will adhere to the specified flightpath during the RF leg. **(T-0)**. Pilots must be able to couple the autopilot or FD to the navigation system (i.e., engage LNAV) by 500 feet AGL during missed approach procedures that include an RF leg. **(T-0)**.

19.9.5. [AIM 1-1-17] To execute a missed approach, activate the missed approach after crossing the missed approach waypoint. GPS missed approach procedures require pilot action to sequence from the missed approach waypoint to the missed approach procedure. If the missed approach is not activated, the GPS receiver displays an extension of the inbound final approach course and displayed distance increases from the missed approach waypoint. Once the missed approach is activated, CDI sensitivity will change to the terminal (+/-1 NM) sensitivity. Missed approach routings in which the first track is via a course rather than direct to the next waypoint require additional action from the pilot to set the course in accordance with aircraft flight manual procedures.

**19.10. Radar Approaches.** [AIM 5-4-11] Precision approach radar (PAR) approaches utilize a radar glidepath to a DA to determine the MAP. ASR approaches utilize an MDA to the MAP. The pilot is advised of the location of the MAP procedure and is advised of the aircraft's position each mile from the runway, airfield, heliport or MAP, as appropriate. At locations where ATC radar service is provided, conform to radar vectors when provided by ATC in lieu of the published missed approach procedure.

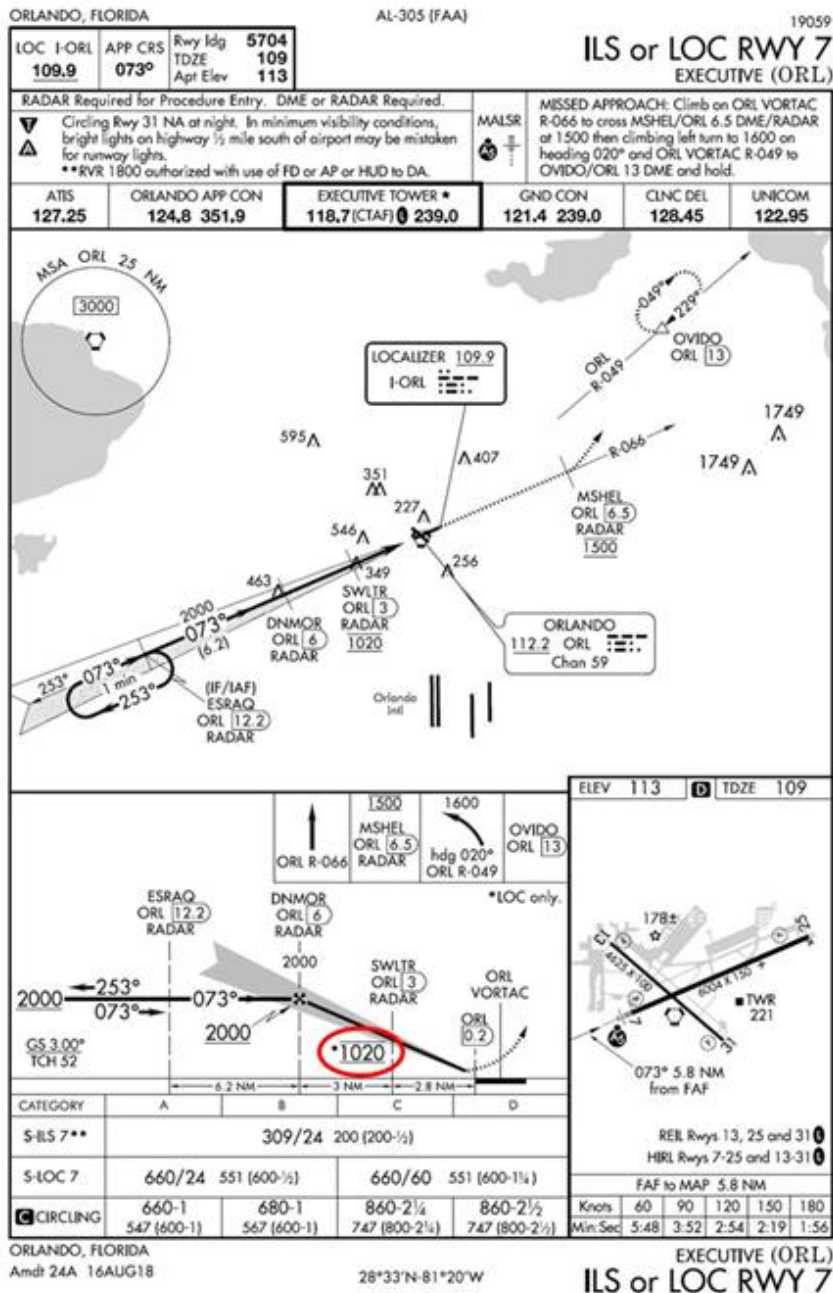
**19.11. CDF A Missed Approach Procedures.** [ICAO Doc 8168 Volume 1] If the visual references required to land have not been acquired when the aircraft is approaching the MDA, the climbing portion of the missed approach is initiated at an altitude above the MDA sufficient to prevent the aircraft from descending below the MDA. At no time is the aircraft flown in level flight at or near the MDA. **Note:** Depending upon the location of the MAP, the descent from the MDA, once the runway environment is in sight, often needs to be initiated prior to reaching the MAP to execute a normal (i.e., 3 degrees) descent to landing.

**19.12. Early Missed Approach Initiation.** When the missed approach is initiated prior to the MAP, the pilot will, unless otherwise cleared by ATC, fly the instrument procedure as specified on the approach plate, including altitude restrictions, to the MAP at or above the MDA, DA, or DH before executing the missed approach instructions. **(T-0)**.

19.12.1. Any turns on the missed approach will not begin until the aircraft reaches the MAP; likewise, if the aircraft reaches the MAP before descending to the MDA, the missed approach will be initiated at the MAP. (T-0).

19.12.2. **Figure 19.1** is an example of an approach altitude restriction that would not permit an early climb should the pilot choose to initiate a missed approach prior to SWLTR. In this example, unless authorized by ATC, a missed approach initiated prior to SWLTR would still require the pilot to descend to the 1,020 feet altitude restriction at SWLTR prior to climbing due to overlying protected airspace for approach routes into Orlando International.

**Figure 19.1. Early Missed Approach Restriction.**



**19.13. Delayed Missed Approach Decision.** Obstacle clearance is the pilot's responsibility if the decision to execute a missed approach occurs beyond the MAP or below the MDA, DA, or DH. Contact ATC as soon as possible to obtain an amended clearance.

19.13.1. If unable to contact ATC for any reason, the pilot should attempt to re-intercept a published segment of the missed approach and comply with route and altitude instructions.

19.13.2. If unable to contact ATC, and in the pilot's judgment it is no longer appropriate to fly the published missed approach procedure, then consider either maintaining visual conditions if practicable and reattempt a landing, or a circle-climb over airfield. Executing a missed approach past the MAP at a location with high terrain may necessitate an excessive climb gradient and make intercepting the published MAP procedure impractical.

19.13.3. Continuous contact with an air traffic facility may not be possible when a missed approach becomes necessary while operating at an airfield that is not served by an operating control tower. The pilot should execute the appropriate missed approach procedure without delay and contact ATC when able to do so.

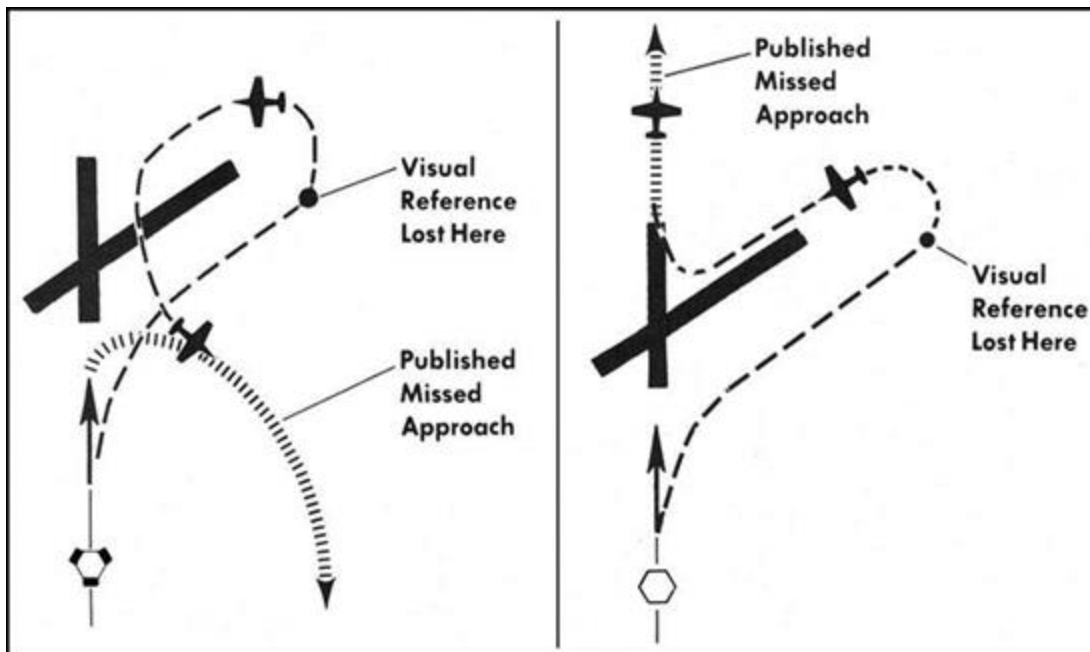
19.13.4. In all cases, prudent mission planning should be performed to consider geographical features, obstacles, restrictions, aircraft performance capabilities. The "Trouble T" section and departure procedures in the terminal procedures publication are a good supplemental source of information for obstacle, takeoff visual climb requirements, and standard climb rate data not specifically expressed on the approach chart.

**19.14. Loss of Visual Reference While Circling.** [AIM 5-4-21; ICAO Doc 8168 Volume 1] If unable to maintain required visual references while circling or unable to make a safe landing execute the missed approach specified for the instrument procedure just flown, unless otherwise directed. Transition from the circling maneuver to the missed approach by executing a climbing turn, within the protected circling area, towards the landing runway, returning to circling altitude or higher. Continue to turn until established on the missed approach course (**Figure 19.2**) or alternate missed approach instructions. An immediate climb must be initiated to ensure climb gradient requirements are met. **(T-0)**.

19.14.1. [ICAO] A missed approach will be executed whenever the runway environment is not in sight during the circling maneuver. **(T-0)**. The runway environment includes features such as the runway threshold, approach lighting aids, or other markings identifiable with the runway.

19.14.2. [NAS Only] A missed approach will be executed whenever an identifiable part of the airfield is not distinctly visible to the pilot during a circling maneuver at or above MDA, unless the inability to see an identifiable part of the airfield results only from a normal bank of the aircraft during the circling maneuver. **(T-0)**.

Figure 19.2. Missed Approach from the Circling Approach.



**19.15. Training – Multiple Approaches.** [FAA Order 7110.65] Prior to the FAF, the controller is required to issue appropriate departure instructions to be followed upon completion of approaches that are not to full stop landings. The pilot should tell the controller how the approach terminates prior to beginning the approach. ATC climb-out instructions include a specific heading or a route of flight and altitude. The controller should state, “After completing low approach/touch-and-go, climb and maintain (altitude). Turn (left or right) heading (degrees).” Climb-out instructions may be omitted after the first approach if instructions remain the same.

## Chapter 20

### EXTREME LATITUDE NAVIGATION

**20.1. General.** Areas of Magnetic Unreliability (AMU) consist of two large areas of operation, centered around the earth's poles where unique features significantly complicate air navigation. The two major factors affecting navigation in the polar regions are magnetic variation and the convergence of true meridians at the poles.

20.1.1. MAJCOMs will provide aircraft-specific operational approval and training prior to authorizing operations using NAVAIDs oriented to true or grid north. As a minimum, procedures and training should address:

20.1.1. (AFMC) Aircraft operation using NAVAIDs oriented to true or grid north are not authorized unless specifically required by a test plan.

20.1.1.1. Identification of areas where reference to true or grid north is required.

20.1.1.2. Procedures for displaying true or grid heading reference.

20.1.1.3. Procedures for verifying magnetic variation information from the aircraft navigation computer. Procedures for inputting manual magnetic variation information,

20.1.1.4. Procedures for returning to automatic magnetic variation computation.

20.1.1.5. Minimum equipment requirements

20.1.1.6. Emergency procedures in the event of true or grid navigation equipment failure while operating in the AMU.

20.1.2. Since the horizontal component of the Earth's magnetic field vanishes near the magnetic poles, magnetic compasses are highly unreliable and unusable in an area approximately 1,000 nautical miles from each magnetic pole. Within these areas, air navigation is further complicated by very rapid changes in magnetic variation over short distances as isogonic lines converge. For example, when flying between the magnetic north pole and the geographic North Pole, a heading of true north results in a magnetic heading of south (magnetic variation of 180).

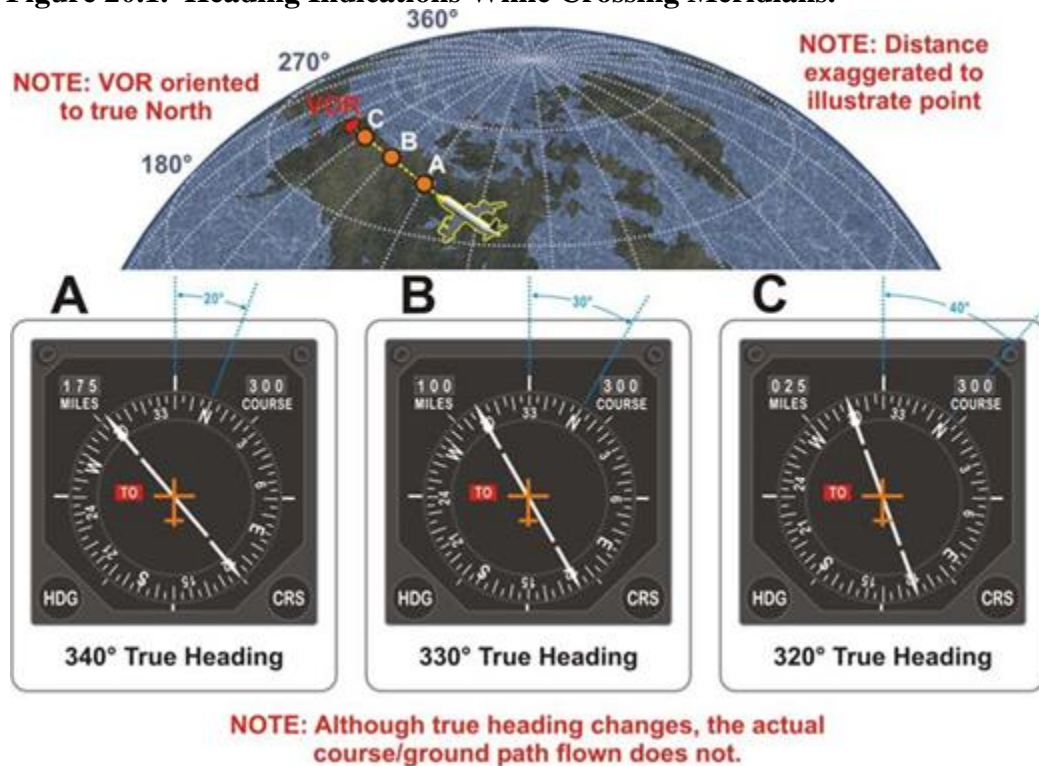
20.1.3. Since the two major AMUs also occur near the geographic poles, the convergence of meridians also presents an additional navigation problem. When flying courses at the extreme latitudes (polar operations), convergence of the meridians can create rapid changes in true headings and true courses with small changes in aircraft position. While maintaining a course without turning, the true heading changes strictly based on the aircraft's relative position to the true pole as it crosses meridians. **Figure 20.1** provides a graphical depiction of how heading information changes in relation to the angular difference from true north as meridians are crossed. As a result, relatively small errors introduced can make determining the aircraft's actual position very difficult when trying to determine the proper heading to fly to maintain or correct back to the desired flight path. When even small errors occur, very large navigation errors can develop over extremely short distances.

20.1.4. Due to the combined effects of magnetic unreliability and the geographic convergence of meridians at acute angles, when flying in the polar regions, to navigate more precisely, a



“grid” system was developed. Navigating in the AMU was also enhanced by the development of gyro driven heading indicators.

**Figure 20.1. Heading Indications While Crossing Meridians.**



## 20.2. Boundaries of the AMU.

20.2.1. The Canadian AIP establishes the basic boundaries for the Northern Hemisphere AMU. In general, this corresponds to Canadian Northern Domestic Airspace, and the entire Canadian Northern and Arctic Control Areas. AMUs are also depicted on Canadian enroute charts. The FAA refers to the Northern Hemisphere AMU as the “north polar area” and defines this region as all geographical areas and airspace located above 78° north.

20.2.2. The FAA refers to the Southern Hemisphere AMU as the “south polar area” and defines this region as any area south of the 60° south latitude.

**20.3. Grid Operations.** Grid navigation is a reorientation of the standard heading references and is used to offset the difficulties of trying to navigate in an AMU (north or south polar area) using conventional techniques and procedures. Grid navigation uses a set of parallel and perpendicular “green” lines depicted on most GNC and JNC charts and enables the aircrew to fly a constant grid heading while crossing rapidly changing longitudinal lines and contend with the erratic magnetic variations present in the AMU. The use of a grid heading, whether provided automatically by on board systems or manually calculated, provides a method upon which an aircrew can safely navigate in an AMU region. Most modern USAF aircraft incorporate a heading reference switch that allows the pilot to select between true, magnetic, or grid. With the heading reference selected to grid mode, the on board navigation systems should automatically switch to grid operations and update the navigation displays to reflect aircraft grid heading and position. In grid mode, the onboard navigation magnetic variation is automatically set to “0” (zero) and therefore magnetic

heading is equal to true heading. The on-board system then applies a known correction (added or subtracted), based on the current longitudinal line to provide a grid heading for the pilot to fly.

20.3.1. There are several ways grid lines may be depicted on charts depending on the type of projection. For example, the polar grid chart is designed using the prime meridian as the base reference line of longitude. An aircrew may calculate a grid heading based on this standard reference.

20.3.2. To manually calculate a grid heading, the pilot needs to multiply the appropriate longitude with the chart's convergence factor (normally stated in the margin) and then add or subtract the aircraft true heading. The convergence factor is particular to the chart being used and is determined by the angle at which the "longitudinal line" cuts across the "grid" line. This angle is known as the convergence angle. In the Southern Hemisphere, the pilot adds "east longitudinal" lines and subtracts "west longitudinal" lines to calculate a grid heading. It is the opposite in the Northern Hemisphere (add "west longitude" and subtract "east longitude"). Since the convergence factor on the polar grid chart is equal to 1 (one), to obtain grid heading, the pilot adds or subtracts the longitudinal line to true heading. As an example, at McMurdo Station, the longitudinal line of the Pegasus Field (NZPG) runway is 167 "east;" therefore for any given true heading, adding 167 gives grid heading. Refer to AFPAM 11-216, Air Navigation for more details on grid navigation.

#### **20.4. Definition of an Emergency in the AMU.**

20.4.1. Many situations are considered an emergency regardless of geographic location. For example, engine failure is considered an emergency by most aircrews whether in or out of the AMU. When operating in the AMU, USAF directives require aircraft to be equipped with a heading source other than magnetic. However, there are situations (e.g., electrical power loss, gyro failure) where the heading source may become inoperative after entering the AMU. A simple gyro failure typically would not be considered an emergency outside the AMU, especially if an alternative means of navigation is available. This situation is dramatically different in the AMU where navigation options may be extremely limited, diversion airfields widely spaced, radar vectors are generally unavailable, weather conditions are less than optimal, and communications often unreliable. Any equipment failure in the AMU that leaves an aircrew with magnetic information as the sole source of heading information is typically considered an emergency.

20.4.2. The techniques outlined below are useful for emergency navigation should the true or grid heading source become inoperative or unreliable while operating in the AMU. Use of these techniques should be limited to emergency navigation to an alternate, the planned destination, or out of the AMU. They should not be used as normal navigation procedures for aircraft not equipped with a heading source other than magnetic.

20.4.2.1. In the unlikely event that all navigation systems become unavailable, reversion to manual navigation (i.e., dead reckoning) is required. Radar, NAVAIDs, or visual fixes may be available. Application of basic navigation principles ensures that the aircraft proceeds in a direction that at least approximates the desired track until more accurate navigation or a safe landing is possible. A thorough review of basic dead reckoning techniques and procedures is recommended prior to flight in the AMU, particularly without a navigator on board. The pilot should always have a backup dead reckoning plan ready for every flight in the AMU. **Note:** Accurately plotting the cleared flight path track on a



suitable chart, along with frequent position checks, helps ensure the flight remains on course. This not only increases and maintains positional awareness but enables the pilot to make the transition to dead reckoning should one or more navigation systems fail.

20.4.2.2. If the aircraft has an additional heading reference system, the pilot may be able to operate the system in directional gyro mode and manually set the heading to coincide with the FMS, true, or inertial heading from the primary navigation source in accordance with flight manual. This provides a backup true heading reference in case the primary navigation system fails. Update the heading periodically in accordance with the flight manual to correct for drift. **Note:** This technique is not acceptable for use as the primary means of navigation but is very useful as an emergency backup source of true heading information.

## 20.5. Using the VOR in the AMU.

### 20.5.1. Flight instrument indications and interpretation:

20.5.1.1. Because of problems associated with magnetic referenced navigation in the AMU, VOR navigation stations are aligned to true north in this area.

20.5.1.2. Flight instrument indications and interpretation for VORs in the AMU are different than for conventional VORs outside the AMU. This is due to convergence of the meridians and the fact that VOR radials are defined at the station, not at the aircraft. The VOR display does not provide a “relative bearing” to the VOR, it uses the received radial and displays it against that azimuth value on the horizontal situation indicator. At lower latitudes, the received radial matches the relative bearing to the station, so there appears to be no difference between them. In the AMU, it is quite likely that the VOR bearing pointer does not point at the station or even at the correct true bearing to the station. This is because the radial being sent out from the station is specific to true north from the station which is slightly different from true north seen at the aircraft.

20.5.1.3. True VOR radials, which are based on phase relationships formed at the VOR transmitter are decoded in the aircraft. The radial leaving the VOR station is based on the meridian (true north) location of the station, while at the aircraft, the VOR radial information is decoded and portrayed using a heading which is based on the meridian at the location of the aircraft, not the VOR station. The difference or apparent error seen on the instruments depends on the aircraft distance from the VOR and the convergence angle of the meridians involved. The difference seen become zero as the VOR station is crossed, where the station and aircraft meridians are the same.

20.5.1.4. Aligning the VORs to true north eliminates the magnetic variation problem and compass unreliability factors but does not eliminate the convergence angle problem.

### 20.5.2. Navigating TO the station:

20.5.2.1. To proceed direct to the station, center the CDI with an inbound bearing and make heading corrections as necessary to keep the CDI centered. Make heading corrections similar to wind corrections to maintain a desired track. Approaching the station, the true heading changes progressively until passing the station when it is the same as the CDI course (+/- wind drift). Reference the VOR indications versus the heading indications represented in [Figure 20.1](#). Do not select magnetic heading references, stay in true heading.

Do not turn to a true heading that places the bearing pointer at the top of the case and keep it there until the aircraft arrives over the station. Doing this would eventually get the aircraft to the station, but it would take the aircraft off the direct course.

#### 20.5.3. Navigating FROM the station:

20.5.3.1. Making use of VOR bearing information in this case is the reverse of the paragraph above. Set the desired outbound radial and keep the CDI centered. The heading required to keep the CDI centered progressively diverges from the CDI course. If the outbound radial is not printed on the chart and outbound information is desired, draw a true north line from the station symbol, then plot a course line from the station and measure the course. Set that radial and keep it centered. This should not be relied upon as the primary means of navigation.

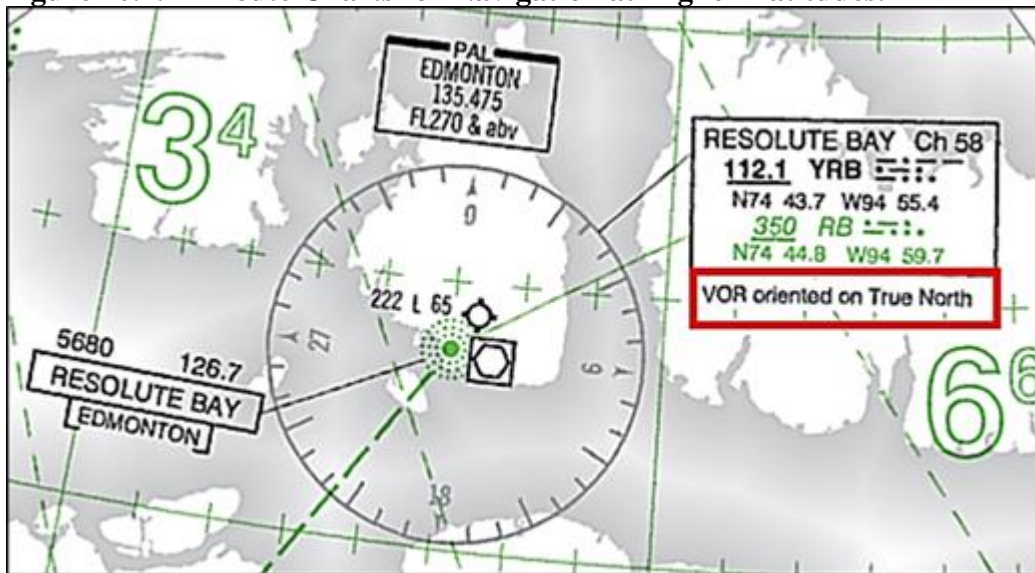
#### 20.5.4. Using off-route true VORs to perform coast-in or coast-out, and enroute accuracy checks:

20.5.4.1. Interpreting bearing information from an off-route VOR station is somewhat involved. Plot a true north line from the station as a reference to draw the true radial or bearing that represents the centered CDI radial. Locate the aircraft's position on this line using the DME indicated distance.

20.5.4.2. To check the FMS indicated true track to the station, plot a true north line from the plotted aircraft position and measure the true track back to the VOR station using the true north line at the aircraft location. This should match the indicated FMS true track. The FMS distance to the VOR station should match the DME indication.

**20.6. Using an NDB in the AMU.** Despite some inherent errors that may cause minor inaccuracies, the NDB offers an excellent source upon which to navigate from in the AMU since the basic operating principle remains unaffected. The automatic direction finder (ADF) needle simply points directly towards the NDB station. Even if the compass card and other navigation anomalies are occurring from operating in the AMU, the ADF needle points to a properly tuned and identified NDB station. This attribute of the NDB can greatly reduce some of the concerns experienced when dealing with the navigation complexities caused by the rapidly changing magnetic variation or meridian convergence at higher latitudes.

**20.7. Enroute Navigation at High Latitudes.** Enroute navigation in higher latitude regions may be based on reference to true or grid north instead of the customary reference to magnetic north. Procedures vary greatly between aircraft type and avionics capabilities. Thorough mission planning is essential to accurate navigation at higher latitudes. Refer to enroute charts for proper heading source and NAVAID orientation ([Figure 20.2](#)).

**Figure 20.2. Enroute Charts for Navigation at Higher Latitudes.**

20.7.1. Normally, navigation north of 70° north latitude or south of 60° south latitude is conducted with reference to true north or grid north. Specific procedures vary greatly depending on aircraft type, avionics capabilities, and crew complement. Unless otherwise annotated, where there is a reference to true north, the text also applies in southern latitudes and applies to navigation with reference to grid north or grid south.

20.7.1.1. There are areas officially designated AMU at extreme high and low latitudes. For areas north of 70° north and south of 60° south that are not officially designated as AMUs, MAJCOMs will determine the highest allowable latitude for aircraft capable of displaying only magnetic heading.

20.7.1.1. (AFMC) Comply with flight manual and MDS lead MAJCOM guidance.

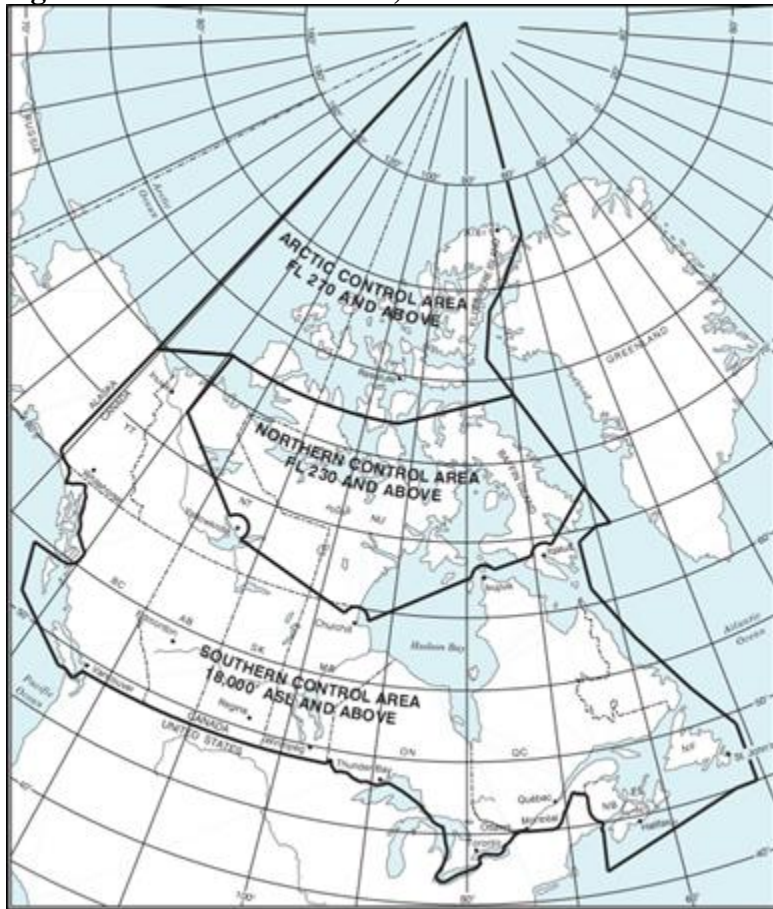
20.7.1.2. Although partly south of 70° north, the entire Canadian Northern and Arctic Control Areas and areas of Northern Domestic Airspace are designated as Areas of Magnetic Unreliability (Figure 20.3).

20.7.2. Aircraft navigation displays must be set to display true north prior to flying true headings or courses. (T-2). Suitably equipped aircraft may also use grid reference.

20.7.3. Outside of designated AMUs, aircraft unable to display true or grid heading may use NAVAIDS oriented to true north for enroute navigation provided procedures listed below are followed.

20.7.3.1. Aircraft navigation computers may automatically provide magnetic variation information. Accuracy of this magnetic variation depends on the period since the last magnetic variation update and aircraft system.

20.7.3.2. When true or grid heading information cannot be displayed, aircraft magnetic variation information must be verified with current aeronautical charts prior to use of area navigation equipment to fly true or grid courses. (T-2). Consult the aircraft flight manual and MAJCOM guidance for specific procedures for navigation with reference to true or grid north.

**Figure 20.3. Canadian Arctic, Northern and Southern Control Areas.**

## 20.8. True North Enroute Procedures.

20.8.1. For navigation using VOR or TACAN, if the NAVAID is oriented to true north, use the following procedures for enroute navigation:

20.8.1.1. If the aircraft allows selection of true north as a heading reference, select true north. No additional corrections are required for courses or headings.

20.8.1.2. If the aircraft does not allow selection of true north as a heading reference, use the following procedures:

20.8.1.2.1. VOR and TACAN courses do not require correction for magnetic variation.

20.8.1.2.2. Set the desired true course in the CDI. The aircraft CDI indicates deviations left and right of the desired true course. With magnetic heading displayed, the bearing pointer does not point to the station, but instead indicates true bearing to the station. Therefore, when established on track, the CDI is centered on the desired true course, but the bearing pointer indicates true bearing to the station and is displaced from aircraft no-wind heading by the amount of station magnetic variation. For example, the Thule magnetic variation was approximately 45° west in 2015 (-0.86 degrees/year rate of change). When proceeding inbound on the Thule 180T radial (360T course), the aircraft no-wind heading is 060, while the bearing pointer points to 360T. This discrepancy

between aircraft heading and desired course may make flight director guidance unreliable.

20.8.1.2.3. All headings require corrections for magnetic variation.

20.8.2. Unlike a VOR or TACAN, an NDB cannot be oriented to true north. ADF needles always display relative bearing to the station. Use the following procedures:

20.8.2.1. If the aircraft allows selection of true north as a heading reference, select true north. No additional corrections are required for relative bearings.

20.8.2.2. If the aircraft does not allow selection of true north as a heading reference, all relative bearings require correction for magnetic variation.

20.8.2.2.1. Aircrew should compute and fly the appropriate magnetic course by correcting the desired true course for the magnetic variation at the current aircraft location. This correction should be updated at least every 5 degrees of magnetic variation or every 30 nautical miles, whichever occurs first.

**20.9. Chart Reading in High Latitudes.** Chart reading in high latitudes presents unique challenges. The nature of the terrain is significantly different, charts are less detailed and less precise, seasonal changes may alter the terrain appearance or hide it completely from view, and there are fewer cultural features.

20.9.1. In high latitudes, there are few distinguishable features from which to determine a position. Built-up features are practically nonexistent and the few that do exist are usually closely grouped, offering little help when flying long navigation legs. Natural features may be limited in variety and are difficult to distinguish from each other. Lakes can seem endless in number and identical in appearance. The countless coastal inlets are extremely difficult to identify. Recognizable, reliable checkpoints are few and far between.

20.9.2. Map reading in high latitudes is further complicated by inadequate charting. Some polar areas are yet to be thoroughly surveyed. The charts portray the appearance of general locales, but many individual terrain features are merely approximated or omitted entirely. In place of detailed outlines of lakes, for example, charts often carry the brief annotation, "Many lakes".

20.9.3. When snow blankets the terrain from horizon to horizon, pilotage becomes acutely difficult. Coastal ice becomes indistinguishable from the land, coastal contours can change dramatically, and many inlets, streams, and lakes disappear. Blowing snow may extend to heights of 200 to 300 feet and may continue for several days, but visibility is usually excellent. However, when snow obliterates surface features and the sky is covered with a uniform layer of clouds so that no shadows are cast, the horizon disappears, causing earth and sky to blend together. This forms an unbroken expanse of white called whiteout. In this complete lack of contrast, distance and height above ground are virtually impossible to estimate. Whiteout is particularly prevalent in northern Alaska during late winter and spring. The continuous darkness of night presents another hazard; nevertheless, surface features are often visible because the snow is an excellent reflector of light from the moon, the stars, and the aurora.

MARK D. KELLY, Lt Gen, USAF  
Deputy Chief of Staff, Operations

**(AFMC)**

EVAN C. DERTIEN, Major General, USAF  
Director of Air, Space and Cyberspace Operations

**Attachment 1****GLOSSARY OF REFERENCES AND SUPPORTING INFORMATION*****References***

- AC 20-131A, Airworthiness Approval of Traffic Alert and Collision Avoidance Systems (TCAS-II) and Mode S Transponders, 29 March 1993
- AC 20-138D, Airworthiness Approval of Positioning and Navigation Systems, 28 March 2014
- AC 20-140C, Guidelines for Design Approval of Aircraft Data Link Communication Systems Supporting Air Traffic Services (ATS), 28 September 2016
- AC 20-150B, Airworthiness Approval of Satellite Voice (SATVOICE) Equipment Supporting Air Traffic Service (ATS) Communication, 23 December 2014
- AC 20-151C, Airworthiness Approval of Traffic Alert and Collision Avoidance Systems (TCAS II), Versions 7.0 & 7.1 and Associated Mode S Transponders, 21 July 2017
- AC 20-165B, Airworthiness Approval of Automatic Dependent Surveillance - Broadcast OUT Systems, 7 December 2015
- AC 20-167A, Airworthiness Approval of Enhanced Vision System, Synthetic Vision System, Combined Vision System, and Enhanced Flight Vision System Equipment, 6 December 2016
- AC 20-172B, Airworthiness Approval for ADS-B In Systems and Applications, 20 May 2015
- AC 70-2A, Reporting of Laser Illumination of Aircraft, 8 February 2013
- AC 90-100A, U.S. Terminal and En Route Area Navigation (RNAV) Operations, 14 April 2015
- AC 90-101A, Approval Guidance for RNP Procedures with AR, 09 February 2016
- AC 90-105A, Approval Guidance for RNP Operations and Barometric Vertical Navigation in the U.S. National Airspace System and in Oceanic and Remote Continental Airspace, 7 March 2016
- AC 90-106A, Enhanced Flight Vision Systems, 2 March 2017
- AC 90-107, Guidance for Localizer Performance with Vertical Guidance and Localizer Performance without Vertical Guidance Approach Operations in the U.S. National Airspace System, 11 February 2011
- AC 90-108, Use of Suitable Area Navigation (RNAV) Systems on Conventional Routes and Procedures, 3 March 2011
- AC 90-114A, Automatic Dependent Surveillance-Broadcast Operations, 7 March 2016
- AC 90-117, Data Link Communications, 3 October 2017
- AC 90-23G, Aircraft Wake Turbulence, 10 February 2014
- AC 90-91K, North American Route Program, 11 December 2008
- AC 90-96A, Approval of U.S. Operators and Aircraft to Operate Under Instrument Flight Rules (IFR) in European Airspace Designated for Basic Area Navigation (B-RNAV) and Precision Area Navigation (P-RNAV), 13 January 2005
- AC 91-70B, Oceanic and Remote Continental Airspace Operations, 1 February 2019



AC 91-85B, Authorization of Aircraft and Operators for Flight in Reduced Vertical Separation Minimum (RVSM) Airspace, 29 January 2019

AC 120-28D, Criteria for Approval of Category III Weather Minima for Takeoff, Landing, and Rollout, 13 July 1999

AC 120-29A, Criteria for Approval of Category I and Category II Weather Minima for Approach, 12 August 2002

AC 120-76D, Authorization for Use of Electronic Flight Bags, 27 Oct 2017

AC 120-108, Continuous Descent Final Approach, 20 January 2011

AC 120-118, Criteria for Approval/Authorization of All Weather Operations (AWO) for Takeoff, Landing, and Rollout, 2 July 2018

AFH 11-203V1, Weather for Aircrews, 12 Jan 2012

AFI 17-221, *Spectrum Interference Resolution Program*, 11 May 2018

AFI 11-202V1, *Aircrew Training*, 27 September 2019

**(Added-AFMC)** AFI 11-202V2, *Aircrew Standardization and Evaluation Program*, 5 December 2018

AFI 11-208, *Department of Defense Notice to Airmen System*, 13 February 2018

AFI 11-209, *Participation in Aerial Events*, 22 May 2018

AFI 11-214, *Air Operations Rules and Procedures*, 14 August 2012

AFI 11-253, *Managing Off-Station Purchases of Aviation Fuel and Ground Services*, 19 August 2013

AFI 11-301V1, *Aircrew Flight Equipment (AFE) Program*, 17 October 2017

AFI 11-401, *Aviation Management*, 10 December 2010

**(Added-AFMC)** AFI11-401\_AFMCSUP, *Aviation Management*, 1 April 2021

AFI 11-403, *Aerospace Physiological Training Program*, 30 November 2012

AFI 11-409, *High Altitude Airdrop Mission Support Program*, 9 September 2015

AFI 13-201, *Airspace Management*, 21 August 2012

AFI 33-115, *Air Force Information Technology (IT) Service Management*, 6 September 2014

AFI 33-322, *Records Management Program*, 4 June 2012

AFI 33-360, *Publications and Forms Management*, 1 December 2015

AFI 48-123, *Medical Examination and Standards*, 5 November 2013

AFI 61-201, *Management of Scientific and Technical Information (STINFO)*, 28 January 2016

AFI 62-601, *USAF Airworthiness*, 11 June 2010

AFI 63-112, *Cockpit Working Groups*, 9 August 2006

AFI 63-137, *Assurance of Communications, Navigation, Surveillance/Air Traffic Management (CNS/ATM), Navigation Safety, and Next Generation Air Transportation System (NextGen) Performance*, 29 March 2012

AFI 65-503, *US Air Force Cost and Planning Factors*, 13 July 2018

AFI 91-202, *The US Air Force Mishap Prevention Program*, 24 June 2015

AFJI 11-204, *Operational Procedures for Aircraft Carrying Hazardous Materials*, 11 November 1994

AFMAN 10-206, *Operational Reporting*, 18 June 2018

**(Added-AFMC)** AFMAN 11-202V3, *Flight Operations*, 9 Jun 2020

AFMAN 11-218, *Aircraft Operations and Movement on the Ground*, 05 April 2019

AFMAN 11-230, *Instrument Procedures*, 24 July 2019

**(Added-AFMC)** AFMAN 11-2FTV1, *Flight Test Aircrew Training*, 25 Feb 2019

**(Added-AFMC)** AFMAN 11-2FTV3, *Flight Test Operations Procedures*, 28 December 2020

AFMAN 11-402, *Aviation and Parachutist Service*, 24 January 2019

AFMAN 11-502, *Small Unmanned Aircraft Systems*, 29 July 2019

AFMAN 17-1203, *Information Technology (IT) Asset Management (ITAM)*, 18 May 2018

AFMAN 17-1301, *Computer Security (COMPUSEC)*, 10 February 2017

AFMAN 33-363, *Management of Records*, 1 March 2008

AFMAN 91-223, *Aviation Safety Investigations and Reports*, 14 September 2018

AFPAM 11-216, *Air Navigation*, 1 March 2001

AFPD 11-2, *Aircrew Operations*, 31 January 2019

AFPD 11-4, *Aviation Service*, 11 Apr 2019

**(Added-AFMC)** DAFI33-360, *Publications and Forms Management*, 15 Dec 2018

EU-OPS 1, *Regulation (EU) No 965/2012 on Air Operations*, 5 October 2012

Federal Aviation Administration (FAA), *Aeronautical Information Manual (AIM)*, 15 August 2019

Federal Aviation Administration Order 6750.24E, *Instrument Landing System and Ancillary Electronic Component Configuration and Performance Requirements*, 29 March 2012

Federal Aviation Administration Joint Order 7110.10AA, *Flight Services*, 15 August 2019

Federal Aviation Administration Joint Order 7400.2M, *Procedures for Handling Airspace Matters*, 28 January 2019

Federal Aviation Administration Joint Order 7610.4V, *Special Operations*, 5 July 2019

Federal Aviation Administration Order 7110.118A, *Land and Hold Short Operations (LAHSO)*, 9 November 2015

- Federal Aviation Administration Order 7930.2S, *Notices to Airmen (NOTAM)*, 11 December 2018
- Federal Aviation Administration Order 8260.19H, *Flight Procedures and Airspace*, 20 July 2017
- Federal Aviation Administration Order 8260.3D, *United States Standard for Terminal Instrument Procedures (TERPS)*, 16 February 2018
- Federal Aviation Administration Order 8260.46G, *Departure Procedure (DP) Program*, 9 November 2018
- Federal Aviation Administration Order 8260.58A, *United States Standard for Performance Based Navigation (PBN) Instrument Procedure Design*, 14 March 2016
- Federal Aviation Administration Order 8400.13F, *Procedures for the Evaluation and Approval of Facilities for Special Authorization Category I Operations and All Category II and III Operations*, 25 October 2019
- Federal Aviation Administration FAA-H-8083-3B, *Airplane Flying Handbook*, 2016
- Federal Aviation Administration FAA-H-8083-15B, *Instrument Flying Handbook*, 2012
- Federal Aviation Administration FAA-H-8083-16B, *Instrument Procedures Handbook*, 2017
- Federal Aviation Administration FAA-H-8083-25B, *Pilot's Handbook of Aeronautical Knowledge*, 2016
- Federal Aviation Administration Order 8900.1 Volume 4, *Aircraft Equipment and Operational Authorizations*, 1 May 2007
- International Civil Aviation Organization Annex 2, *Rules of the Air*, July 2005
- International Civil Aviation Organization Annex 10 Volume 1, *Radio Navigation Aids*, Seventh Edition, July 2018
- International Civil Aviation Organization Annex 14 Volume 1, *Aerodrome Design and Operations*, July 2018
- International Civil Aviation Organization Annex 15, *Aeronautical Information Services*, July 2018
- International Civil Aviation Organization Document 4444, *Air Traffic Management*, 2016
- International Civil Aviation Organization Document 7030, *Regional Supplementary Procedures*, 2014
- International Civil Aviation Organization Document 8168 Volume 1, *Aircraft Operations – Flight Procedures*, 2006
- International Civil Aviation Organization Document 8168 Volume 2, *Aircraft Operations – Construction of Visual and Instrument Flight Procedures*, 2014
- International Civil Aviation Organization Document 8400, *ICAO Abbreviations and Codes*, 10 Nov 2016
- International Civil Aviation Organization Document 9613, *Performance-based Navigation (PBN) Manual*, 2013

International Civil Aviation Organization Document 9849, *Global Navigation Satellite System (GNSS) Manual*, 2013

International Civil Aviation Organization Document 9869, *Performance-based Communication and Surveillance (PBCS) Manual*, 2017

International Civil Aviation Organization Document 10037, *Global Operational Data Link (GOLD) Manual, First Edition*, 2017

Federal Aviation Administration Joint Order 7110.65Y, *Air Traffic Control*, 20 June 2019

North Atlantic Operations Document 007, *North Atlantic Operations and Airspace Manual*, version 2019-2, 28 March 2019

RECAT-EU, *European Wake Turbulence Categorization and Separation Minima on Approach and Departure*, 15 July 2015

SS521-AG-PRO-010, *U.S. Navy Diving Manual*, 11 January 2017.

T.O. 42C-1-2, *Anti-Icing De-Icing and Defrosting of Parked Aircraft*

Title 14, Code of Federal Regulations, Part 1, *Definitions and Abbreviations*

Title 14, Code of Federal Regulations, Part 73, *Special Use Airspace*

Title 14, Code of Federal Regulations, Part 121, *Operating Requirements: Domestic, Flag, and Supplemental Operations*

Title 14, Code of Federal Regulations, Part 135, *Operating Requirements: Commuter and on Demand Operations and Rules Governing Persons on Board Such Aircraft*

Title 14, Code of Federal Regulations, Part 91, *General Operating and Flight Rules*

Title 14, Code of Federal Regulations, Part 93, *Special Air Traffic Rules*

Title 14, Code of Federal Regulations, Part 95, *IFR Altitudes*

Title 14, Code of Federal Regulations, Part 97, *Standard Instrument Procedures*

Title 14, Code of Federal Regulations, Part 99, *Security Control of Air Traffic*

Title 47, Code of Federal Regulations, Part 22, *Public Mobile Services*

TSO-C145e, *Airborne Navigation Sensors Using the Global Positioning System Augmented by The Satellite Based Augmentation System (SBAS)*, 5 May 2017

TSO-C146e, *Stand-Alone Airborne Navigation Equipment Using The Global Positioning System Augmented By the Satellite Based Augmentation System (SBAS)*, 5 May 2017

US AIP, *United States of America Aeronautical Information Publication*, 15 August 2019

### ***Prescribed Forms***

AF Form 70, *Pilot's Flight Plan And Flight Log*

DD-1801, *International Flight Plan, DoD*

DD-1801C, *International Flight Plan, DoD (Continuation)*

***Adopted Forms***

AF Form 679, *Air Force Publication Compliance Item Waiver Request/Approval*

AF Form 847, *Recommendation for Change of Publication*

(Added-AFMC) AF Form 1381, *USAF Certification of Aircrew Training*

(Added-AFMC) AFMC Form 73, *AFMC Flight Operations Waiver Request*

DD Form 2131, *Passenger Manifest*

***Abbreviations and Acronyms***

**ABAS**—Aircraft-Based Augmentation System

**AC**—Advisory Circular

**ACC**—Air Combat Command

**ACES**—Aeronautical Content Exploitation System

(Added-AFMC) **ACF**—Acceptance Check Flight

**ACP**—Actual Communication Performance

**ADF**—Automatic Direction Finder

**ADIZ**—Air Defense Identification Zone

**ADS-B**—Automatic Dependent Surveillance – Broadcast

**AETC**—Air Education and Training Command

**AF**—Air Force

**AFAFRICA**—Air Forces Africa

**AFDW**—Air Force District of Washington

**AFSA**—Air Force Flight Standards Agency

**AFI**—Air Force Instruction

**AFJI**—Air Force Joint Instruction

**AFH**—Air Force Handbook

**AFGSC**—Air Force Global Strike Command

**AFMC**—Air Force Material Command

**AFMAN**—Air Force Manual

**AFPD**—Air Force Policy Directive

**AFRC**—Air Force Reserve Command

**AFREP**—Air Force Representative to the FAA

**AFSOC**—Air Force Special Operations Command

**AGL**—Above Ground Level

**(Added-AFMC) AHAS**—Avian Hazard advisory System  
**AI**—Attitude Indicator  
**AIM**—Aeronautical Information Manual  
**AIR CARD ®**—Aviation Into-Plane Reimbursement Card  
**AIRAC**—Aeronautical Information Regulation and Control  
**AIP**—Aeronautical Information Publication  
**ALS**—Approach Lighting System  
**ALSF**—Approach Lighting System with Sequenced Flashing Lights  
**ALTRV**—Altitude Reservation  
**AMC**—Air Mobility Command  
**AMU**—Area of Magnetic Unreliability  
**ANG**—Air National Guard  
**AP**—Area Planning  
**APV**—Approach with Vertical Guidance  
**AR**—Authorization Required  
**ASAP**—Aviation Safety Action Program  
**ASDA**—Accelerate-Stop Distance Available  
**ASR**—Airport Surveillance Radar  
**ATC**—Air Traffic Control  
**ATCAA**—Air Traffic Control Assigned-Airspace  
**ATM**—Air Traffic Management  
**ATS**—Air Traffic Services  
**ATIS**—Automatic Terminal Information Service  
**Baro-VNAV**—Barometric Vertical Navigation  
**BC**—Back Course  
**BDS**—BeiDou Navigation Satellite System  
**CAT**—Category  
**CDFA**—Continuous Descent Final Approach  
**CDI**—Course Deviation Indicator  
**CFIT**—Controlled Flight Into Terrain  
**CFR**—Code of Federal Regulations  
**CIV**—Civilian

**CNS**—Communication, Navigation, and Surveillance

**CNS/ATM**—Communications, Navigation, and Surveillance/Air Traffic Management

**CTAF**—Common Traffic Advisory Frequency

**DA**—Decision Altitude

**DAFIF**—Digital Aeronautical Flight Information File

**DAIP**—DoD Aeronautical Information Portal

**(Added-AFMC) DCMA**—Defense Contract Management Agency

**DDA**—Derived Decision Altitude

**DER**—Departure End of Runway

**DH**—Decision Height

**DIA**—Defense Intelligence Agency

**DME**—Distance Measuring Equipment

**DNIF**—Duties Not Including Flying

**DVA**—Diverse Vector Area

**DVFR**—Defense Visual Flight Rules

**DVOF**—Digital Vertical Obstruction File

**EFB**—Electronic Flight Bag

**EGPWS**—Enhanced Ground Proximity Warning System

**EGNOS**—European Geostationary Navigation Overlay System

**ELT**—Emergency Locator Transmitter

**ERAA**—Emergency Route Abort Altitude

**ESA**—Emergency Safe Altitude

**ETA**—Estimated Time of Arrival

**ETP**—Equal Time Point

**EU**—European Union

**FAA**—Federal Aviation Administration

**FAF**—Final Approach Fix

**FBO**—Fixed-Base Operator

**(Added-AFMC) FCF**—Functional Check Flight

**FCG**—Foreign Clearance Guide

**FCIF**—Flight Crew Information Files

**FD**—Fault Detection



**FDE**—Fault Detection and Exclusion  
**FDP**—Flight Duty Period  
**FIH**—Flight Information Handbook  
**FL**—Flight Level  
**FLIP**—Flight Information Publication  
**FMS**—Flight Management System  
**(Added-AFMC) FOA**—Flight Operations Authority  
**FOD**—Foreign Object Damage  
**FSS**—Flight Service Station  
**FTE**—Flight Technical Error  
**FTIP**—Foreign Terminal Instrument Procedure  
**GAGAN—GPS and Geo**—Augmented Navigation System  
**GBAS**—Ground Based Augmentation System  
**GCAS**—Ground Collision Avoidance System  
**GDSS**—Global Decision Support System  
**GEO**—Geostationary Earth Orbit  
**GLONASS**—Globalnaya Navigazionnaya Sputnikovaya Sistema  
**GLS**—GBAS Landing System  
**GNSS**—Global Navigation Satellite System  
**GPS**—Global Positioning System  
**GPWS**—Ground Proximity Warning System  
**HAA**—Height Above Airfield  
**HAT**—Height Above Touchdown  
**HEEDS**—Helicopter Emergency Egress Device System  
**Hg**—Mercury  
**HILPT**—Hold-In-Lieu-of Procedure Turn  
**HIRL**—High Intensity Runway Lighting  
**HPMA**—High Performance Military Aircraft  
**hPa**—Hectopascals  
**HUD**—Head-Up-Display  
**IAF**—Initial Approach Fix  
**IAP**—Instrument Approach Plate

**ICAO**—International Civil Aviation Organization

**IF**—Intermediate Fix

**IFR**—Instrument Flight Rules

**ILS**—Instrument Landing System

**IM**—Inner Marker

**IMC**—Instrument Meteorological Conditions

**IR**—IFR Military Training Routes

**IRU**—Inertial Reference Unit

**ISA**—International Standard Atmosphere

**JMCS**—Jeppesen® Military Chart Service

**JNC**—Jet Navigation Chart

**JO**—Joint Order

**JOG-A**—Joint Operations Graphics-Air

**KIAS**—Knots Indicated Airspeed

**LAAS**—Local Area Augmentation System

**LAHSO**—Land and Hold Short Operations

**LDA**—Landing Distance Available

**LDA**—Localizer Type Directional Aid

**LLZ**—Localizer

**LNAV**—Lateral Navigation

**LOC**—Localizer

**LP**—Localizer Performance

**LPV**—Localizer Performance with Vertical Guidance

**MAJCOM**—Major Command

**MALSRL**—Medium Intensity Approach Lighting System with Runway Alignment Indicator Lights

**MAP**—Missed Approach Point

**mb**—Millibars

**MDA**—Minimum Descent Altitude

**MDS**—Mission Design Series

**MDM**—Mobile Device Management

**MEA**—Minimum Enroute Altitude

**(Added-AFMC) MESP**—Mission Essential Support Personnel

**MHz**—Megahertz  
**MIL**—Military  
**MIPS**—Military Instrument Procedure Standardization  
**MM**—Middle Marker  
**MOA**—Military Operations Area  
**MOCA**—Minimum Obstruction Clearance Altitude  
**MON**—Minimum Operational Network  
**MSA**—Minimum Safe Altitude  
**MSAS**—Multi-function Satellite Augmentation System  
**MSL**—Mean Sea Level  
**MTR**—Military Training Route  
**MVA**—Minimum Vectoring Altitude  
**N/A**—Not Applicable  
**NA**—Not Authorized  
**NAS**—National Airspace System  
**NAT HLA**—North Atlantic High Level Airspace  
**NATO**—North Atlantic Treaty Organization  
**NAVAID**—Navigation Aid  
**NDB**—Non-Directional Beacon  
**NGA**—National Geospatial-Intelligence Agency  
**NGB**—National Guard Bureau  
**NM**—Nautical Mile  
**NOTAM**—Notice to Airmen  
**NSA**—National Security Area  
**NSE**—Navigation System Error  
**NVD**—Night Vision Devices  
**ODP**—Obstacle Departure Procedure  
**OIS**—Obstacle Identification Surface  
**OM**—Outer Marker  
**ONC**—Operational Navigation Chart  
**(Added-AFMC) OPCON**—Operational Control  
**OPR**—Office of Primary Responsibility

**OROCA**—Off Route Obstacle Clearance Altitude

**ORTCA**—Off Route Terrain Clearance Altitude

**PACAF**—Pacific Air Forces

**PANS-OPS**—Procedures for Air Navigation Services-Aircraft Operations

**PAR**—Precision Approach Radar

**PBCS**—Performance-Based Communication and Surveillance

**PBN**—Performance-Based Navigation

**PDE**—Path Definition Error

**PED**—Portable Electronic Device

**PFR**—Primary Flight Reference

**PIC**—Pilot in Command

**PinS**—Point-in-Space

**(Added-AFMC) POV**—Privately Owned Vehicle

**PPS**—Precise Position Service

**PRM**—Precision Runway Monitor

**RA**—Resolution Advisory

**RAIM**—Receiver Autonomous Integrity Monitoring

**RCLS**—Runway Centerline Light System

**RCP**—Required Communication Performance

**(Added-AFMC) RCR**—Runway Condition Reading

**RECAT-EU**—European Wake Vortex Re-categorization

**RF**—Radius-To-Fix

**RNAV**—Area Navigation

**RNP**—Required Navigation Performance

**ROBD**—Reduced Oxygen Breathing Device

**RSP**—Required Surveillance Performance

**RSRS**—Reduced Same Runway Separation

**RTRL**—Reduced Takeoff Runway Length

**RVR**—Runway Visual Range

**RVSM**—Reduced Vertical Separation Minimum

**RWY**—Runway

**SARP**—Standards and Recommended Practices

**SBAS**—Satellite-Based Augmentation System  
**SDCM**—System for Differential Corrections and Monitoring  
**SDP**—Special Departure Procedure  
**SID**—Standard Instrument Departure  
**SIGMET**—Significant Meteorological Information  
**SFO/ELP**—Simulated Flameout, Forced Landing, or Emergency Landing Patterns  
**SM**—Statute Mile  
**(Added-AFMC) SOF**—Supervisor of Flying  
**SOIA**—Simultaneous Offset Instrument Approach  
**SPINS**—Special Instructions  
**SPO**—System Program Office  
**SPS**—Standard Positioning Service  
**SR**—Slow Speed Low Altitude Training Route  
**SSALR**—Simplified Short Approach Lighting System with Runway Alignment Indicator Lights  
**STAR**—Standard Terminal Arrival  
**STIG**—Security Technical Information Guide  
**SVFR**—Special Visual Flight Rules  
**TA**—Transition Altitude  
**TAA**—Terminal Arrival Area  
**TAC**—Terminal Area Chart  
**TACAN**—Tactical Air Navigation  
**TAWS**—Terrain Awareness and Warning System  
**TCAS**—Traffic Collision Avoidance System  
**TCH**—Threshold Crossing Height  
**TDZ**—Touchdown Zone  
**TDZE**—Touchdown Zone Elevation  
**TEMPO**—Temporary  
**TERPS**—Terminal Instrument Procedures  
**TFR**—Temporary Flight Restriction  
**TLM**—Topographic Line Map  
**TLv**—Transition Level  
**T.O.**—Technical Order

**TODA**—Takeoff Distance Available

**TORA**—Takeoff Run Available

**TPC**—Tactical Pilotage Chart

**(Added-AFMC) TPS**—Test Pilot School

**TSE**—Total System Error

**TSO**—Technical Standard Order

**UAS**—Unmanned Aircraft System

**UNICOM**—Universal Communications

**U.S.**—United States

**USA**—United States Army

**USAF**—United States Air Force

**USAFE**—United States Air Forces Europe

**USG**—U.S. Government

**USN**—United States Navy

**VASI**—Visual Approach Slope Indicator

**VCOA**—Visual Climb Over the Airport

**VDA**—Vertical Descent Angle

**VDB**—VHF Data Broadcast

**VDP**—Visual Descent Point

**VFR**—Visual Flight Rules

**VGSI**—Visual Glideslope Indicator

**VHF**—Very High Frequency

**VMC**—Visual Meteorological Conditions

**VNAV**—Vertical Navigation

**VOR**—Very High Frequency (VHF) Omni-Directional Range

**VORTAC**—Very High Frequency (VHF) Omni-directional Range/Tactical Air Navigation

**VPA**—Vertical Path Angle

**VR**—VFR Military Training Route

**VVI**—Vertical Velocity Indicator

**WAAS**—Wide Area Augmentation System

**WGS**—World Geodetic Survey

**WPA2**—Wi-Fi Protected Access 2

### *Terms*

**Abeam**—An aircraft is “abeam” a fix, point, or object when that fix, point, or object is approximately 90 degrees to the right or left of the aircraft track. Abeam indicates a general position rather than a precise point.

**Aerobatic Flight**—An intentional maneuver involving an abrupt change in an aircraft’s attitude, an abnormal attitude, or abnormal acceleration not necessary for normal flight. [FAA Pilot/Controller Glossary]

**Aircrew Member**—An individual, designated on the Flight Authorization who is an aircrew member as explained in AFPD 11-4, Aviation Service, AFMAN 11-402, *Aviation and Parachutist Service*, is assigned to a position listed in AFI 65-503, US Air Force Cost and Planning Factors, and is designated on orders to fulfill specific aeronautical tasks.

**Airfield**—An area on land or water that is used or intended to be used for the landing and takeoff of aircraft; includes its buildings and facilities, if any. The FAA term “airport” and the ICAO term “aerodrome” may be used interchangeably with airfield for the purposes of this manual. An area prepared for the accommodation (including any buildings, installations, and equipment), landing, and takeoff of aircraft [JP3-17].

**Air Force Flight Standards Agency (AFFSA)**—The Field Operating Agency charged with the development, standardization, evaluation and certification of procedures, equipment and standards to support global flight operations.

**Airport Reference Point**—The official horizontal geographic location of an airport. It is the approximate geometric center of all usable runways at an airport. [FAA Order 8260.3]

**Airspace Concept**—An airspace concept describes the intended operations within a defined airspace. Airspace concepts are developed to satisfy explicit strategic objectives such as improved safety, increased air traffic capacity, and mitigation of environmental impact. Airspace concepts can include details of the practical organization of the airspace and its users based on specific assumptions (e.g., route structure, separation minima) [ICAO Doc 9613].

**Air Traffic Control (ATC)**—A service operated by appropriate authority to promote the safe, orderly and expeditious flow of air traffic [AIM Pilot/Controller Glossary].

**Aircraft Approach Category**—Aircraft approach category is equal to the stall speed ( $V_{so}$ ) multiplied by 1.3 or stall speed ( $V_{s1g}$ ) multiplied by 1.23 in the landing configuration at the maximum certificated landing mass. If both  $V_{so}$  and  $V_{s1g}$  are available, the higher resulting speed is used [ICAO Doc 8168 Volume 1].

**Alternate Airfield**—An airfield at which an aircraft may land if a landing at the intended airfield becomes inadvisable [AIM Pilot/Controller Glossary].

**Alternate Means of Navigation**—The use of a suitable RNAV system in lieu of operational conventional NAVAIDS without monitoring those NAVAIDS.

**Altimeter Setting**—The barometric pressure reading used to adjust a pressure altimeter for variations in existing atmospheric pressure or to the standard altimeter setting (29.92 inches Hg) [AIM Pilot/Controller Glossary].

**Altitude**—The height of a level, point, or object measured in feet AGL or MSL [AIM Pilot/Controller Glossary].



**Anti-collision Lights**—The primary flashing light system on the aircraft intended to attract the attention of others to enhance sense-and-avoid operations.

**Approach with Vertical Guidance (APV)**—A term used to describe RNAV approach procedures that provide lateral and vertical guidance but do not meet the requirements to be considered a precision approach [AIM Pilot/Controller Glossary].

**Arc**—The track over the ground of an aircraft flying at a constant distance from a NAVAID by reference to DME [AIM Pilot/Controller Glossary].

**Area Navigation (RNAV)**—A method of navigation which permits aircraft operation on any desired flight path within the coverage of ground-based or space-based NAVAIDs or within the limits of the capability of self-contained aids, or a combination of these.

**Augmented Crew**—A basic aircrew supplemented by additional aircrew members to permit in-flight rest. If the basic aircrew requires only one pilot and a second qualified pilot (includes pilots enrolled in an AETC formal aircrew training course) is designated an aircrew member to augment pilot duties, the crew can be considered augmented.

**Automatic Dependent Surveillance—Broadcast (ADS-B)**—A surveillance system in which an aircraft or vehicle to be detected is fitted with cooperative equipment in the form of a data link transmitter. The aircraft or vehicle periodically broadcasts its GPS-derived position and other information, such as velocity, over the data link to a ground-based transmitter/receiver (transceiver) for processing and display at an air traffic control facility. [FAA Pilot/Controller Glossary].

**Bearing**—The horizontal direction to or from any point, usually measured clockwise from true north, magnetic north, or some other reference point through 360 degrees [AIM Pilot/Controller Glossary].

**Civil Twilight**—Defined to begin in the morning, and end in the evening when the center of the Sun is geographically 6 degrees below the horizon [U.S. Naval Observatory]. Both periods of twilight are considered “day”, unless further restricted by the MAJCOM.

**Class 1 EFB Hardware**—Portable commercial off-the-shelf (COTS)-based computers, considered to be portable electronic devices (PED) with no aircraft manufacturer and/or system program office (SPO) design, production, or installation approval for the device and its internal components. Class 1 EFBs are not mounted to the aircraft, connected to aircraft systems for data, or connected to a dedicated aircraft power supply. Class 1 EFBs can be temporarily connected to an existing aircraft power supply for battery recharging. Class 1 EFBs that have Type B applications for aeronautical charts, approach charts, or an electronic checklist must be appropriately secured and viewable during critical phases of flight and must not interfere with flight control movement. (Portable Class 1 EFB components are not considered to be part of aircraft type design; i.e., not in the aircraft type certificate or supplemental type certificate.)

**Class 2 EFB Hardware**—Portable COTS-based computers, considered to be personal electronic devices with no aircraft manufacturer and/or SPO design, production, or installation approval for the device and its internal components. Class 2 EFBs are typically mounted. They must be capable of being easily removed from or attached to their mounts by flight-crew personnel. Class 2 EFBs can be temporarily connected to an existing aircraft power supply for battery recharging. They may connect to aircraft power, data ports (wired or wireless), or installed antennas, provided those

connections are installed in accordance with aircraft manufacturer or system program office guidelines. (Portable Class 2 EFB components are not considered to be part of aircraft design.)

**Class 3 EFB Hardware**—EFBs permanently installed in the aircraft in accordance with applicable airworthiness regulations.

**Compatible Published Approach**—An instrument approach procedure that is published in Flight Information Publications, and if required contained in the aircraft flight management system database, that the aircraft is equipped with the appropriate certified avionics and the aircrew is trained, current, and certified to fly.

**Compatible Published Approach Minimums**—The minimum weather or altitude for flight on a published instrument approach procedure. This term is used throughout this manual to address variations in MAJCOM guidance when authorizing flight under IFR.

**Contact Approach**—A procedure that may be used by a pilot in lieu of conducting an instrument procedure to an airfield.

**Controlled Cockpit Rest**—A rest period that an aircrew member may use when authorized by MAJCOM. Controlled cockpit rest is useful during long duty days when an aircrew member may be fatigued during the airborne operation of an aircraft. This rest period will not replace or be a substitute for official crew rest.

**Controlled Flights**—ICAO definition for any flight which is subject to an ATC clearance.

**Course Line**—A line between any two points on a route.

**Critical Phase of Flight**—In the absence of MAJCOM guidance, this term should include: terminal area operations including taxi, takeoff and landing, low-level flight, air refueling, airdrop, weapons employment, flight using NVDs, tactical or air combat and formation operations (other than cruise), and all portions of any test or functional check flight or any aerial demonstration.

**(Added-AFMC) Critical Phase of Flight**—For the purposes of this AFMAN, this term includes: terminal area operations including takeoff and landing, low-level flight, air refueling, close formation, airdrop, actual weapons delivery, simulated weapon delivery (other than level), tactical/air combat operations, envelope expansion test points, and any aerial demonstration. NVD wear in and of itself does not constitute a critical phase of flight.

**Day**—The time between the beginning of morning civil twilight and the end of evening civil twilight, as published in the Air Almanac.

**Dead Reckoning**—The navigation of an airplane solely by means of computations based on airspeed, course, heading, wind direction, groundspeed, and elapsed time.

**Decision Altitude (DA)**—A specified barometric altitude (MSL) on an instrument approach procedure (ILS, GLS, vertically guided RNAV) at which the pilot decides whether to continue the approach or initiate an immediate missed approach if the pilot does not see the required visual references [AIM Pilot/Controller Glossary].

**Decision Height (DH)**—With respect to the operation of aircraft, means the height at which a decision is made during an ILS or PAR instrument approach to either continue the approach or to execute a missed approach. Decision height is referenced to the threshold elevation (e.g., radar altimeter) [AIM Pilot/Controller Glossary].

**Departure Procedure**—A preplanned IFR departure procedure published for pilot use, in graphic or textual format, that provides obstruction clearance from the terminal area to the appropriate enroute structure. There are two types of departure procedures: ODP which are printed textually or graphically, and SID which are printed graphically [AIM Pilot/Controller Glossary].

**Diverse Departure**—If the airfield has at least one published approach, the absence of any non-standard takeoff minimums or IFR departure procedures for a specific runway normally indicates that runway meets diverse departure criteria.

**Diverse Vector Area**—In a radar environment, that area in which a prescribed departure route is not required as the only suitable route to avoid obstacles. The area in which random radar vectors below the MVA or minimum IFR altitude, established in accordance with the design criteria for diverse departures, obstacles and terrain avoidance, may be issued to departing aircraft [AIM Pilot/Controller Glossary].

**Electronic Flight Bag (EFB)**—An electronic display system intended primarily for flight deck use that includes the hardware and software necessary to support an intended function. EFB devices can display a variety of aviation data or perform basic calculations (e.g., performance data, fuel calculations). In the past, some of these functions were traditionally accomplished using paper references, or were based on data provided to the flight-crew by a flight dispatch function. The scope of the EFB functionality may include various other hosted databases and applications. Physical EFB displays may use various technologies, formats, and forms of communication. An EFB must be able to host Type A and/or Type B software applications.

**Emergency Fuel**—The point at which it is necessary to proceed directly to the airport of intended landing due to low fuel. Declaration of “emergency fuel” is an explicit statement that priority handling by ATC is both required and expected.

**FAA Exemption or Authorization**—An official written FAA document which provides the petitioner relief from specified parts of the CFRs.

**Fault Detection and Exclusion (FDE)**—A function performed by some GNSS receivers, which can detect the presence of a faulty satellite signal and exclude it from the position calculation [ICAO Doc 9613].

**Final Approach Course**—A bearing, radial, or track of an instrument approach leading to a runway or an extended runway centerline all without regard to distance [AIM Pilot/Controller Glossary].

**Final Approach Fix (FAF)**—The fix from which the final approach to an airfield is executed and which identifies the beginning of the final approach segment. It is designated on U.S. Government charts by the “Maltese Cross” symbol for non-precision approaches and the “lightning bolt” symbol for precision approaches; or when ATC directs a lower-than-published glidepath or vertical path intercept altitude, it is the resultant actual point of the glidepath or vertical path intercept [AIM Pilot/Controller Glossary].

**Fix**—A geographical position determined by visual reference to the surface, by reference to one or more radio NAVAIDs, by celestial plotting, or by another navigation device [AIM Pilot/Controller Glossary].

**Flight Management System (FMS)**—A computer system that uses a large database to allow routes to be preprogrammed and fed into the system by means of a data loader. The system is

constantly updated with respect to position accuracy by reference to conventional NAVAIDs. The sophisticated program and its associated database ensures that the most appropriate aids are automatically selected during the information update cycle [AIM Pilot/Controller Glossary].

**Formation Flight**—[FAA Pilot/Controller Glossary] More than one aircraft which, by prior arrangement between the pilots, operate as a single aircraft with regard to navigation and position reporting. Separation between aircraft within the formation is the responsibility of the flight leader and the pilots of the other aircraft in the flight. This includes transition periods when aircraft within the formation are maneuvering to attain separation from each other to effect individual control and during join-up and breakaway.

a. A standard formation is one in which a proximity of no more than 1 mile laterally or longitudinally and within 100 feet vertically from the flight leader is maintained by each wingman.

b. Nonstandard formations are those operating under any of the following conditions:

1. When the flight leader has requested and ATC has approved other than standard formation dimensions.

2. When operating within an authorized altitude reservation (ALTRV) or under the provisions of a letter of agreement.

3. When the operations are conducted in airspace specifically designed for a special activity.

**Fuel Reserve**—The amount of usable fuel that must be carried on each aircraft beyond that required to complete the flight as planned.

**Global Navigation Satellite System (GNSS)**—GNSS refers collectively to the worldwide positioning, navigation, and timing determination capability available from one or more satellite constellations in conjunction with a network of ground stations [AIM Pilot/Controller Glossary].

**Ground Based Augmentation System (GBAS)**—A ground based GNSS station which provides local differential corrections, integrity parameters and approach data via VHF data broadcast to GNSS users to meet real-time performance requirements for precision approaches. The aircraft applies the broadcast data to improve the accuracy and integrity of its GNSS signals and computes the deviations to the selected approach. A single ground station can serve multiple runway ends up to an approximate radius of 23 nautical miles [AIM Pilot/Controller Glossary].

**Groundspeed**—Groundspeed is the speed of the aircraft over the ground. Normally expressed in nautical miles per hour (knots).

**Height Above Touchdown (HAT)**—The height of the Decision Height or Minimum Descent Altitude above the highest runway elevation in the touchdown zone (first 3,000 feet of the runway). HAT is published on instrument approach charts in conjunction with all straight-in minimums [AIM Pilot/Controller Glossary].

**Inner Marker (IM)**—A marker beacon used with a CAT II ILS precision approach located between the middle marker and the end of the ILS runway. Transmits a radiation pattern keyed at six dots per second and indicating aurally and visually that the pilot is at the designated DH. Normally 100 feet above the touchdown zone elevation, on the ILS CAT II approach. It also marks progress during a CAT III approach [AIM Pilot/Controller Glossary].

**Instrument Approach**—A series of predetermined maneuvers for the orderly transfer of an aircraft under instrument flight conditions from the beginning of the initial approach to a landing or to a point from which a landing may be made visually [AIM Pilot/Controller Glossary].

**Instrument Flight Rules (IFR)**—Rules governing the procedures for conducting instrument flight. Also a term used by pilots and controllers to indicate type of flight plan [AIM Pilot/Controller Glossary].

**Instrument Meteorological Conditions (IMC)**—Meteorological conditions expressed in terms of visibility, distance from cloud, and ceiling less than the minima specified for visual meteorological conditions [AIM Pilot/Controller Glossary, JP-03].

**Intermediate Fix (IF)**—The fix that identifies the beginning of the intermediate approach segment of an instrument approach procedure [AIM Pilot/Controller Glossary].

**International Civil Aviation Organization (ICAO)**—A United Nations Specialized Agency, established by ICAO States in 1944 to manage the administration and governance of the Convention on International Civil Aviation (Chicago Convention). ICAO works with the Convention's 192 ICAO Member States and industry groups to reach consensus on international civil aviation SARPs and policies in support of safe, efficient, secure, economically sustainable and environmentally responsible civil aviation sector.

**Kollsman Window**—A barometric scale window of a sensitive altimeter used to adjust the altitude for the altimeter setting [FAA-H-8083-25].

**Land and Hold Short Operations (LAHSO)**—Operations which include simultaneous takeoffs and landings or simultaneous landings when a landing aircraft is able and is instructed by the controller to hold-short of the intersecting runway, taxiway or designated hold-short point. Pilots are expected to promptly inform the controller if the hold short clearance cannot be accepted. [FAA Pilot/Controller Glossary]

**Lateral Navigation (LNAV)**—A function of area navigation equipment which calculates, displays, and provides lateral guidance to a profile or path [AIM Pilot/Controller Glossary].

**Low Close-in Obstacles**—Obstacles that require a climb gradient greater than 200 feet per nautical mile to an altitude of 200 feet or less above the DER [FAA Order 8260.46].

**Magnetic Course**—The true course corrected for magnetic variation.

**Magnetic Variation**—The difference between true north and magnetic north. The magnetic variation is annotated on navigation charts, is different from one position on the earth to another and varies slightly over time.

**Marker Beacon**—An electronic navigation facility transmitting a 75 MHz vertical fan or bone-shaped radiation pattern. Marker beacons are identified by their modulation frequency and keying code, and when received by compatible airborne equipment, indicate aurally and visually that the pilot is passing over the facility [AIM Pilot/Controller Glossary].

**Minimum Descent Altitude (MDA)**—The lowest altitude, expressed in feet above mean sea level, to which descent is authorized on final approach or during circle-to-land maneuvering in execution of a standard instrument approach procedure where no electronic glideslope is provided [AIM Pilot/Controller Glossary].

**Minimum Fuel**—Indicates that an aircraft's fuel supply has reached a state where, upon reaching the destination, it can accept little or no delay. This is not an emergency situation but merely indicates an emergency situation is possible should any undue delay occur. [FAA Pilot/Controller Glossary]

**Mode S**—A secondary surveillance radar process that allows selective interrogation of aircraft according to the unique 24-bit address assigned to each aircraft [ICAO Annex 10].

**Mountainous Terrain**—ICAO PANS-OPS defines mountainous terrain as an area over which the changes of surface elevation exceed 900 meters (3,000 feet) within a distance of 18.5 kilometers (10.0 nautical miles). Defined in 14 CFR 95.11 for the NAS.

**National Airspace System (NAS)**—The common network of U.S. airspace; air navigation facilities, equipment and services, airfields or landing areas; aeronautical charts, information and serviced; rules regulations and procedures, technical information, and manpower and material. Included are system components shared jointly with the military [AIM Pilot/Controller Glossary].

**NAVAID Infrastructure**—Refers to the ground-based and space-based NAVAIDs available to meet requirements in the navigation specification [ICAO Doc 9613].

**Navigation Aid (NAVAID)**—Any visual or electronic device airborne or on the surface which provides point-to-point guidance information or position data to aircraft in flight [AIM Pilot/Controller Glossary].

**Navigation Application**—The application of a navigation specification and the supporting NAVAID infrastructure, to routes, procedures, and defined airspace volume in accordance with the intended airspace concept [ICAO Doc 9613].

**Navigation Specification**—A set of aircraft and aircrew requirements needed to support PBN operations within a defined airspace. There are two kinds of navigation specification: RNAV specifications and RNP specifications [ICAO Doc 9613].

**Night**—The time between the end of evening civil twilight and the beginning of morning civil twilight, as published in the Air Almanac, converted to local time [AIM Pilot/Controller Glossary].

**Non-precision Approach**—An instrument approach based of a navigation system which provides course deviation but no glidepath deviation information (e.g., VOR, NDB, LNAV) [AIM Pilot/Controller Glossary].

**Notice to Airmen (NOTAM)**—A notice containing information (not known sufficiently in advance to publicize by other means) concerning the establishment, condition, or change in any component (facility, service, or procedure of, or hazard in the NAS) the timely knowledge of which is essential to personnel concerned with flight operations [AIM Pilot/Controller Glossary].

**Obstacle**—An existing object, object of natural growth, or terrain at a fixed geographical location or which may be expected at a fixed location within a prescribed area with reference to which vertical clearance is provided during flight operation [AIM Pilot/Controller Glossary]. Any natural or man-made obstruction designed or employed to disrupt, fix, turn, or block the movement of an opposing force, and to impose additional losses in personnel, time, and equipment on the opposing force [JP 3-15].

**Obstacle Identification Surface (OIS)**—An inclined or level surface associated with a defined area for obstruction evaluation [FAA Order 8260.3].

**Obstacle Departure Procedure (ODP)**—A preplanned IFR departure procedure printed for pilot use in textual or graphic form to provide obstruction clearance via the least onerous route from the terminal area to the appropriate enroute structure [AIM Pilot/Controller Glossary]. **Note:** Low close in obstacles alone do not constitute an ODP.

**Oceanic Airspace**—Airspace over the oceans of the world, considered international airspace, where oceanic separation and ICAO procedures are applied. Responsibility for the provisions of ATC service in this airspace is delegated to various ICAO States based generally upon geographic proximity and availability of required resources [AIM Pilot/Controller Glossary].

**Off-Route Obstruction Clearance Altitude (OROCA)**—An off-route altitude which provides obstruction clearance with a 1,000 foot buffer in non-mountainous terrain areas and a 2,000 foot buffer in designated mountainous areas within the United States. This altitude may not provide signal coverage from ground-based navigational aids, air traffic control radar, or communications coverage. [FAA Pilot/Controller Glossary]

**Off-Route Terrain Clearance Altitude (ORTCA)**—An off-route attitude which provides terrain clearance within each bounded latitude/longitude quadrant as shown on DoD IFR charts. This altitude provides terrain clearance of 3,000 feet. This altitude may not provide signal coverage from ground-based navigational aids, air traffic control radar, or communications coverage. [FLIP GP]

**Outer Marker (OM)**—A marker beacon at or near the glideslope intercept altitude of an ILS approach [AIM Pilot/Controller Glossary].

**P-Coded Civil Airports**—U.S. civil airport wherein permit covers use by transient military aircraft. [FLIP IFR Supplement]

**Passenger**—An individual onboard the aircraft who is not on the flight authorization. See AFI 11-401 for further guidance.

**Performance-based Navigation (PBN)**—Area navigation based on performance requirements for operating along an air traffic route, on an instrument procedure, or in a designated airspace [ICAO Doc 9613].

**Pilot Flying**—On multi-pilot aircraft, is the pilot maneuvering the aircraft and responsible to control and monitor the aircraft's flight path and energy state, including autopilot systems if engaged.

**Portable Electronic Devices (PEDs)**—Portable electronic devices which are not installed on an aircraft as standard equipment. PEDs may include temporary mounts, a data interface, an external antenna, and may require aircraft electrical power.

**Precise Positioning Service (PPS)**—GPS service available to authorized users via the encrypted P(Y) code ranging signal. The P(Y) code is the encrypted GPS signal. PPS can offer greater accuracy and resistance to jamming and spoofing.

**Precision Approach**—An instrument approach based on a navigation system that provides course and glidepath deviation information meeting the precision standards of ICAO Annex 10 (i.e., PAR, ILS, and GLS) [AIM Pilot/Controller Glossary].



**Precision Runway Monitor (PRM) Approach**—An approach conducted to parallel runways separated by less than 4,300 feet and the parallel runways have a precision radar monitoring system that permits simultaneous independent instrument approaches.

**Predictive RAIM (P-RAIM)**—Using a standard set of algorithms, the availability of RAIM may be determined based on the satellite coverage expected at an aircraft's ETA. Due to terrain masking and other factors (e.g., satellite fails after RAIM prediction made), P-RAIM does not guarantee there will be sufficient satellite coverage on arrival. P-RAIM does not have to reside in the GPS receiver. It can be provided by FAA Flight Service (US **NAS Only**) and other ground-based RAIM algorithms.

**Prevailing Visibility**—The greatest horizontal visibility observed throughout at least half of the horizon circle. It need not be continuous throughout 180 consecutive degrees. [AIM Pilot/Controller Glossary]

**Primary Flight Reference (PFR)**—Any display or suite of displays and instruments used to present the basic flight information needed for immediate control of the aircraft. PFR includes attitude (climb or dive angle or pitch and vertical velocity, bank angle, and a prominent horizon reference), indicated or calibrated airspeed, barometric altitude, heading, appropriate fault indications, and the capability to recognize and recover from an unusual attitude. UAS PFR includes link status, flight guidance mode, and logic.

**Procedure Turn**—The maneuver prescribed when it is necessary to reverse direction to establish an aircraft on the intermediate approach segment or final approach course. The outbound course, direction of turn, distance within which the turn is to be completed, and minimum altitude are specified in the procedure. However, unless otherwise restricted, the point at which the turn may be commenced and the type and rate of turn are left to the discretion of the pilot [AIM Pilot/Controller Glossary].

**QFE**—Atmospheric pressure at airfield elevation (or at runway threshold) [ICAO Doc 8168 Volume 1].

**QNE**—The barometric pressure used for the standard altimeter setting (29.92 inches Hg) [AIM Pilot/Controller Glossary].

**QNH**—The barometric pressure as reported by a particular station [AIM Pilot/Controller Glossary].

**Radar**—A device which, by measuring the time interval between transmission and reception of radio pulses and correlating the angular orientation of the radiated antenna beam or beams in azimuth or elevation, provides information on range, azimuth, or elevation of objects in the path of the transmitted pulses [AIM Pilot/Controller Glossary].

**Radar Required**—A term displayed on charts and approach plates and included in FDC NOTAMs to alert pilots that segments of either an instrument approach or a route are not navigable because of either the absence or unusability of a NAVAID.

**Receiver Autonomous Integrity Monitoring (RAIM)**—A technique whereby a civil GNSS receiver determines the integrity of the GNSS navigation signals without reference to sensors or non-DoD integrity systems other than the receiver itself. This determination is achieved by a consistency check among redundant pseudorange measurements [AIM Pilot/Controller Glossary].

**Reduced Same Runway Separation**—Allows reduction of the normal ATC aircraft separation standards during landings and touch-and-goes and restricted low approach operations to increase the airport and runway capacity. [FAA JO 7110.65]

**Reduced Takeoff Runway Length Procedure (RTRL)**—Method used by TERPS to reduce high IFR climb gradients by shortening the available takeoff runway, thus increasing the distance to the obstacle, spot elevation, or terrain feature. It is normally printed in the IAP section. An example of an RTRL is “...or with standard takeoff minimums and a normal 200'/NM climb gradient, takeoff must occur no later than 2200' prior to departure end of runway.”

**Reduced Vertical Separation Minimum (RVSM)**—RVSM airspace is where ATC separates aircraft by a minimum of 1,000 feet vertically between FL290 and FL410 inclusive [FAA-H-8083-16].

**Relief**—means of graphically portraying important topographic features ranging from ridge lines, canyons and peaks in rugged terrain, to isolated sharply rising hills in areas of flat terrain.

**Remote or Island Destination**—In the absence of more restrictive MAJCOM guidance, pilots will consider a remote or island destination as any aerodrome that, due to its unique geographic location, offers no suitable alternate within two hours flying time.

**Reporting Point**—A geographical location in relation to which the position of an aircraft is reported [AIM Pilot/Controller Glossary].

**Required Navigation Performance (RNP)**—A statement of the navigation performance necessary for operation within a defined airspace [AIM Pilot/Controller Glossary].

**RNAV Approach**—An instrument approach procedure which relies on aircraft area navigation equipment for navigation guidance [AIM Pilot/Controller Glossary].

**RNAV Operations**—Operations using area navigation for RNAV applications [ICAO Doc 9613].

**RNAV System**—Navigation system which permits aircraft operation on any desired flight path within the coverage of station-referenced NAVAIDs or within the limits of the capability of self-contained aids, or a combination of these. An RNAV system may be included as part of an FMS [ICAO Doc 9613].

**RNP APCH**—RNP APCH has a lateral approach accuracy of 1 nautical mile in the terminal and missed approach segments and scales to 0.3 nautical miles in the final approach. “RNAV (GPS)” is equivalent to “RNP APCH” [AIM 1-2-2; ICAO Doc 9613].

**RNP AR APCH**—RNP AR APCH capability requires specific aircraft performance, design, operational processes, and specific procedure design criteria to achieve the required target level of safety. RNP AR APCH has lateral accuracy values that can range below 1 nautical mile in the terminal and missed approach segments and scale to RNP 0.3 or lower in the final approach. “RNAV (RNP)” is equivalent to “RNP AR APCH” [AIM 1-2-2; ICAO Doc 9613].

**RNP Operations**—Operations using an RNP system for RNP navigation applications [ICAO Doc 9613].

**RNP System**—Area navigation system which supports on-board performance monitoring and alerting [ICAO Doc 9613].

**Runway Visual Range (RVR)**—The range over which the pilot of an aircraft on the centerline of a runway can see the runway surface markings or the lights delineating the runway or identifying its centerline [AIM Pilot/Controller Glossary].

**Self-Contained Approach**—An arrival procedure, normally from an IFR altitude, to a runway, using only navigational equipment onboard the aircraft (GPS, radar, or other sensors).

**Smooth Flight**—An academic concept taught throughout a pilot's career and is found throughout industry technical handbooks. Used in this AFMAN only to highlight that maneuvering an aircraft with reference to the onboard instruments is a skill to be mastered.

**Special Departure Procedure (SDP)**—Aircraft-specific commercially designed and published procedures that require MAJCOM training and certification before use.

**Standard Instrument Departure (SID)**—A preplanned IFR departure procedure printed in graphic form to provide obstacle clearance and a transition from the terminal area to the appropriate enroute structure [AIM Pilot/Controller Glossary].

**Standard Positioning Service (SPS)**—GPS service available to all users via the course/acquisition (C/A) code ranging signal.

**Standard Rate Turn**—A turn of three degrees per second [AIM Pilot/Controller Glossary].

**Standard Terminal Arrival (STAR)**—A preplanned IFR arrival procedure published graphic [AIM Pilot/Controller Glossary].

**Stepdown Fix**—A fix permitting additional descent within a segment of an instrument approach procedure by identifying a point at which a controlling obstacle has been safely overflown [AIM Pilot/Controller Glossary].

**Stopway**—An area beyond the takeoff runway no less wide than the runway and centered upon the extended centerline of the runway, able to support the airplane during an aborted takeoff, without causing structural damage to the airplane, and designated by the airfield authorities for use in decelerating the airplane during an aborted takeoff [AIM Pilot/Controller Glossary].

**Strobe Lights**—Systems such as wingtip strobes or other similar strobe light installations.

**Substitute Means of Navigation**—The use of a suitable RNAV system in lieu of out-of-service conventional NAVAIDS or non-installed or non-operable avionics.

**Tactical Air Navigation (TACAN)**—An ultra-high frequency electronic rho-theta air navigation aid which provides suitably equipped aircraft a continuous indication of bearing and distance to the TACAN station [AIM Pilot/Controller Glossary].

**Tactical Operations**—Flight operations consisting of maneuvers that are unique to the employment of air power to: gain and maintain air superiority, prevent freedom of operation for the enemy in the objective area, and to assist naval and ground forces in the attainment of their objectives. Tactical operations must be specifically MAJCOM (or CCMD) defined, approved and implemented. These operations are normally practiced only on training or exercise missions, in a form of special use airspace or on designated training ranges or routes.

**Terminal Area**—A general term used to describe airspace in which approach control service or airfield traffic control service is provided [AIM Pilot/Controller Glossary].

**Terminal Area Operations**—Terminal area operations are normally those flight phases conducted within 30 NM of an airfield of intended departure or landing, or those operations on charted Standard Instrument Departures, on charted Standard Terminal Arrivals (STARs), or other flight operations between the last enroute fix or waypoint and an initial approach fix or waypoint.

**Terrain Alert Warning System (TAWS)**—Generic term for any on-board system taking inputs from terrain databases, radar altimeter, aircraft position sensors, etc. to activate a Ground Proximity Warning System or Automatic Ground Collision Avoidance System (AGCAS). Developed to help prevent Controlled Flight Into Terrain (CFIT) mishaps.

**Threshold Crossing Height (TCH)**—The theoretical height above the runway threshold at which the aircraft's glideslope antenna would be if the aircraft maintains the trajectory established by the mean ILS glideslope or the altitude at which the calculated glidepath of RNAV or GPS approaches [AIM Pilot/Controller Glossary].

**Touchdown Zone Elevation (TDZE)**—The highest elevation in the first 3,000 feet of the landing surface [AIM Pilot/Controller Glossary].

**Track**—The actual flight path of an aircraft over the earth or a specified course [JP 3-01].

**Traffic Collision Avoidance System (TCAS)**—An airborne collision avoidance system based on radar beacon signals which operates independent of ground-based equipment.

**Transponder**—The airborne radar beacon receiver/transmitter portion of the Air Traffic Control Radar Beacon System (ATCRBS) which automatically receives radio signals from interrogators on the ground, and selectively replies with a specific reply pulse or pulse group only to those interrogations being received on the mode to which it is set to respond [AIM Pilot/Controller Glossary].

**True Airspeed**—True airspeed is the speed of an aircraft relative to the air surrounding it.

**True Course**—The intended horizontal direction of travel over the surface of the earth, expressed as an angle measured clockwise from true north (000 degrees) through 359 degrees.

**True Heading**—True heading is the horizontal direction in which an aircraft is pointed in relation to true north.

**Type A Software Applications**—Type A applications are those paper replacement applications primarily intended for use during flight planning, on the ground, or during noncritical phases of flight.

**Type B Software Applications**—Type B applications are those paper replacement applications that provide the aeronautical information required to be accessible for each flight at the pilot station, and are primarily intended for use during flight planning and all phases of flight. Type B applications include miscellaneous, non-required applications (e.g., aircraft cabin and exterior surveillance video displays, maintenance applications).

**Type C Software Applications**—Software approved using RTCA/DO-178B compliance or another acceptable means. These are non-EFB software applications found in avionics and include intended functions for communications, navigation, and surveillance that require aircraft manufacturer or SPO design, production, and installation approval. Type C applications are for airborne functions with a failure condition classification considered to be a major hazard or higher.

**Unmanned Aircraft System (UAS)**—An unmanned aircraft and its associated elements related to safe operations, which may include control stations (ground, ship, or air based) control links, support equipment, payloads, flight termination systems, and launch and recovery equipment. It consists of three elements: unmanned aircraft, control station, and data link. [FAA Pilot/Controller Glossary]. A UAS must meet all applicable requirements of a manned aircraft unless specifically exempted. That system whose components include the necessary equipment, network, and personnel to control an unmanned aircraft [JP 3-30].

**Unmonitored NAVAID**—Most NAVAIDs have internal monitoring systems that provide automatic shutdown or notification when a malfunction occurs. Unmonitored NAVAIDs lack the ability to immediately notify ATC when a malfunction occurs. The pilot may still use the NAVAID for all types of navigation, including instrument approaches, but must monitor the NAVAID for a loss of identification since no prior warning of operation may be available from ATC.

**Unreliable Relief**—Source materials are insufficient to show a complete illustration of relief.

**Vertical Navigation (VNAV)**—A function of area navigation equipment which calculates, displays, and provides vertical guidance to a profile or path [AIM Pilot/Controller Glossary].

**Very High Frequency (VHF)**—The frequency band between 30 and 300 MHz. Portions of this band, 108 to 118 MHz, are used for certain NAVAIDs; 118 to 136 MHz are used for civil air and ground voice communications [AIM Pilot/Controller Glossary].

**Visual Descent Point (VDP)**—A defined point on the final approach course of a non-precision straight-in approach procedure from which normal descent from the MDA to the runway touchdown point may be commenced, provided the approach threshold of that runway, or approach lights, or other markings identifiable with the approach end of that runway are clearly visible to the pilot [AIM Pilot/Controller Glossary].

**Visual Flight Rules (VFR)**—Rules that govern the procedures for conducting flight under visual conditions. The term “VFR” is also used in the United States to indicate weather conditions that are equal to or greater than minimum VFR requirements. In addition, it is used by pilots and controllers to indicate type of flight plan [AIM Pilot/Controller Glossary].

**VFR-on-Top**—ATC authorization for an IFR aircraft to operate in VFR conditions at any appropriate VFR altitude (as specified in FLIP and restricted by ATC). A pilot receiving this authorization must comply with VFR visibility, cloud distance criteria, and minimum IFR altitudes. [FAA Pilot/Controller Glossary]

**VFR-over-the-Top**—VFR flight maneuver during which an aircraft on a VFR flight plan climbs over a ceiling in VMC, maintains VMC above the clouds, then descends in VMC and lands.

**Visual Meteorological Conditions (VMC)**—Meteorological conditions expressed in terms of visibility, distance from cloud, and ceiling equal to or better than specified minima [AIM Pilot/Controller Glossary].

**Vortices**—Circular patterns of air created by the movement of an airfoil through the air when generating lift. As an airfoil moves through the atmosphere in sustained flight, an area of low pressure is created above it. The air flowing from the high pressure area to the low pressure area around and about the tips of the airfoil tends to roll up into two rapidly rotating vortices, cylindrical in shape. These vortices are the most predominant parts of aircraft wake turbulence and their rotational force is dependent upon the wing loading, gross weight, and speed of the generating

aircraft. The vortices from medium to super aircraft can be of extremely high velocity and hazardous to smaller aircraft [AIM Pilot/Controller Glossary].

**Wake Turbulence**—Phenomena resulting from the passage of an aircraft through the atmosphere. The term includes vortices, thrust stream turbulence, jet blast, jet wash, propeller wash, and rotor wash both on the ground and in the air [AIM Pilot/Controller Glossary].

**Wide Area Augmentation System (WAAS)**—A satellite navigation system consisting of the equipment and software which augments the GPS Standard Positioning Service (SPS). The WAAS provides enhanced integrity, accuracy, availability, and continuity over and above GPS SPS. The differential correction function provided improved accuracy required for precision approaches. [FAA Pilot/Controller Glossary].

**World Geodetic Survey-1984 (WGS-84)**—Developed by the U.S. for world mapping, WGS-84 is the ICAO standard for an earth fixed global reference frame.

## Attachment 2

### THE "60-TO-1 RULE"

What is the "60-to-1 rule"?

The 60-to-1 Rule is a technique for determining the pitch attitude or pitch change required to satisfy a climb/descent gradient. It is also a technique used to determine lateral displacement in "degrees" for course interceptions and offset computations.

1. It allows the pilot to compute the pitch attitude when ESTABLISHING an attitude during the CONTROL AND PERFORMANCE procedure.
2. It reduces the pilot's workload and increases efficiency by requiring fewer changes and less guess work.
3. It gives an alternative to the "TLAR" (that looks about right) method of instrument flying.
4. You can teach the "60-to-1 RULE" as opposed to trying to teach experience, as in the "TLAR" method.

Simply stated the "60-to-1" rule is:

1° = 1 NM at 60 NM  
or  
1° = 100 Ft at 1 NM

Let's look at relationship. First look at a circle with a 60 NM radius.

We know that the circumference of a circle is  $2\pi r$ , therefore the mathematical data supporting this:

$$\text{Circumference} = 2 \times 3.1416 \times 60 \\ = 376.99 \text{ NM}$$

Since there are 360° in a circle, we can determine the length of a 1° arc:  
 $376.99 \text{ NM} / 360^\circ = 1.05 \text{ NM per Degree}$  or, approximately 1 NM per degree at 60 NM

Since 1 NM = 6076 Ft or about 6000 Ft,  
**1° = 6000 Ft at 60 NM**

This relationship is true not only in the horizontal plane, but also in the vertical plane. If this 1° = 6000 Ft at 60 NM relationship is drawn in the form of a vertically inclined plane and the height of the plane is measured at different points, you can see that there is a definite relationship between the height of the 1° plane and the distance from the apex of the 1° angle. The height of the plane at 1 NM is 100 Ft, therefore,

This relationship is constant. If the distance (NM) or the angle is changed, the altitude (Ft) is changed by the same factor.

That is,

1° = 100 Ft at 1 NM  
or  
1° = 100 Ft/NM

At 1 NM, 3° = 300 Ft  
 At 10 NM, 3° = 3000 Ft etc.

In this relationship, 1° = 100 Ft/NM, if the distance is changed, multiply the altitude by the same factor. If the angle is changed, multiply the altitude by the same factor. If both the distance and the angle are changed, multiply the altitude by both factors. Notice that in the discussion of the mathematical data, there has been no mention of aircraft type or speed. Speed has no effect on the 1° = 100 Ft/NM relationship! Look at the following Example.

An O-1 at 60 KTAS and an F-15 at 180 KTAS over a 10 NM distance on a 300 Ft/NM descent gradient (3° pitch change from level flight)

[a] How many Ft/NM will the O-1 travel?  
 Answer: 300

[b] How many Ft/NM will the F-15 travel?  
 Answer: 300

Both aircraft fly the same descent gradient since their pitch changes are the same. Speed has no effect!



Before we discuss how a rate of descent, Ft/Min, can be derived from a pitch change or descent gradient, aircraft speed must be expressed in Nautical Miles per Minute (NM/Min)

$$\text{From TAS: NM/Min} = \frac{\text{TAS}}{60}$$

If TAS is 420,  $\text{NM/Min} = \frac{420}{60} = 7 \text{ NM/Min}$

$$\text{From MACH number: NM/Min} = \text{MACH} \times 10$$

If MACH is .7,  $\text{NM/Min} = .7 \times 10 = 7 \text{ NM/Min}$

This relationship is true when 600 NM/Hr is the speed of sound. Since it's always close, MACH can be used to approximate NM/Min. NM/Min can be determined from IAS by converting IAS to TAS. There are two methods available:

a.  $\text{TAS} = \text{IAS} + \text{IAS} \times (2\% \text{ per } 1000')$   
 If IAS is 250 and altitude is FL 200  
 $\text{TAS} = 250 + 250 \times (.02 \times 20)$   
 $= 250 + 250 \times .4$   
 $= 250 + 100 \text{ KIAS} = 350$

b.  $\text{TAS} = \text{IAS} + \frac{\text{Flight Level}}{2}$   
 $= 250 + 100 \text{ KIAS} = 350$

Now from the example above:

$$\text{NM/Min} = \frac{350}{60} = 5.8 \text{ or } 6 \text{ NM/Min}$$

Now back to the O-1 and the F-15:

The O-1 at 60 KTAS is traveling at 1 NM/Min

The F-15 at 180 KTAS is traveling at 3 NM/Min

How long will it take each aircraft to travel the 10 NM in the example? O-1 at 1 NM/Min takes 10 Min, F-15 at 3 NM/Min takes 3.3 Min.

What will each aircraft's VVI be indicating during the 3000 Ft descent?

$$\text{O-1's VVI} = \frac{3000 \text{ Ft}}{10 \text{ Min}} = 300 \text{ Ft/Min}$$

$$\text{F-15's VVI} = \frac{3000 \text{ Ft}}{3.3 \text{ Min}} = 900 \text{ Ft/Min}$$

By restating some previous facts, a relationship between Pitch, Gradient and VVI is clear.

- (1) The O-1 is traveling at 1 NM/Min and its VVI is indicating 300 Ft/Min for a 300 Ft/NM gradient or 3° pitch change. (Remember 1° = 100 Ft/NM)
- (2) The F-15 is traveling at 3NM/Min and its VVI is indicating 900 Ft/Min for a 300 Ft/NM gradient or 3° pitch change.

$$\text{VVI} = \text{NM/Min} \times \text{Ft/NM}$$

or

The VVI for each 1° of pitch change is equal to speed in NM/Min x 100 Ft/NM.

Example: An aircraft makes a 6° pitch change from level flight (it establishes a 600 Ft/NM climb/descent gradient). What does the VVI indicate if the speed is .8 MACH?

$$\text{NM/Min} = .8 \times 10 = 8 \text{ NM/Min}$$

$$\text{VVI} = 8 \text{ NM/Min} \times 600 \text{ Ft/NM}$$

$$\text{VVI} = 4800 \text{ Ft/Min}$$

### Practical Applications

1. You're climbing at 285 KIAS (.6 MACH) and 3000 Ft/Min. What pitch change do you make to level off?

$$\frac{3000 \text{ Ft/Min}}{6 \text{ NM/Min}} = 500 \text{ Ft/NM} = 5^\circ$$

2. ARTCC tells you to climb to FL 250 and be at FL 250 in 10 NM. You're currently at FL 200 and are indicating .6 MACH. What minimum pitch change is necessary, what should your VVI indicate, and can you make it?

$$\frac{5000 \text{ Ft}}{10 \text{ NM}} = 500 \text{ Ft/NM} = 5^\circ$$

$$6 \text{ NM/Min} \times 500 \text{ Ft/NM} = 3000 \text{ Ft/Min}$$

*Whether you make it or not depends upon your aircraft's performance capability, but at least you know what you need to establish to make it.*

3. You're at FL 330 proceeding direct to the BFD TACAN. ARTCC clears you to descend to 3000 Ft and cross the TACAN at 3000 Ft. You are now 50 DME from the TACAN, what do you do? Lower your pitch 6° and verify this by checking that your VVI reads 600 Ft/NM x NM/Min.

$$\frac{33,000 \text{ Ft} - 3000 \text{ Ft}}{50 \text{ NM}} = 600 \text{ Ft/NM} = 6^\circ$$

If you are indicating .7 MACH, your VVI should read:

$$600 \text{ Ft/NM} \times 7 \text{ NM/Min} = 4200 \text{ Ft/Min}$$

During the descent, you slow to .5 MACH. What should your VVI read if you are still maintaining the 600 Ft/NM descent gradient?

$$600 \text{ Ft/NM} \times 5 \text{ NM/Min} = 3000 \text{ Ft/Min}$$

So far, all of our calculations have been "no wind." How does wind affect the relationship between pitch, VVI and the descent gradient?

Let's add a 60 kt tailwind to the last problem. You still need to descend at 600 Ft/NM (fly a 600 Ft/NM descent gradient), but you must figure your VVI using NM/Min in groundspeed.

The no-wind speed was .7 MACH or 7 NM/Min

The groundspeed in NM/Min is 7 NM/Min + 60 kts

$$\begin{array}{l} \text{or} \\ 7 \text{ NM/Min} + 1 \text{ NM/Min} = 8 \text{ NM/Min} \end{array}$$

Now, the required VVI to fly the 600 Ft/NM is:

$$\text{VVI} = 8 \text{ NM/Min} \times 600 \text{ Ft/NM} = 4800 \text{ Ft/Min}$$

To find the pitch change necessary to get this VVI, the "in the air" NM/Min formula must be used.

$$\frac{4800 \text{ Ft/Min}}{7 \text{ NM/Min}} = 690 \text{ Ft/NM} = \text{Approx. } 7^\circ$$

(since 1° = 100 Ft/NM)

The no wind answer was 6° with a VVI of 4200 Ft/Min.

This 1° pitch correction for the 60 kt wind is a good figure to remember. It is not an exact relationship, but it is within ½° in most cases.

For example, if you have a 120 kt tailwind, you must increase your pitch change by about 2° to realize the computed gradient. If you have a 60 kt headwind, you can decrease your pitch change by about 1° to fly the computed gradient.

## Horizontal Plane

Turn radius of your aircraft

Distance to turn 90° using 30° of bank.

a. NM/Min - 2 or (Mach x 10) - 2

b.  $\frac{(NM/Min)^2}{10}$  or  $(Mach)^2 \times 10$

The more accurate method is b., but a. is easier and will give a small "pad" in determining a lead point.

For turns other than 90° use the following:

| Degrees To Turn | Fraction Of 90° Turn |
|-----------------|----------------------|
| 180°            | 2                    |
| 150°            | 1 5/6                |
| 135°            | 1 2/3                |
| 120°            | 1 1/2                |
| 90°             | 1                    |
| 60°             | 1/2                  |
| 45°             | 1/3                  |
| 30°             | 1/6                  |

Determining the lead point for intercepting a radial.

First determine the turn radius of the aircraft. Now convert that turn radius to a number of degrees. For a 90° turn, as in turning from an arc to a radial, the formula is simple:

$$\text{Lead Degrees} = \frac{\text{Turn Radius(NM)} \times 60}{\text{DME}}$$

By the 60-to-1 rule, on the 60 DME arc 1° = 1 NM and on the 10 DME arc, 1° = 1/6 NM or 1 NM = 6°. From this, the number of degrees per NM on any arc can be determined by 60/DME. To find the lead point in degrees, just multiply this factor by the lead point in NM.

For example, how many degrees lead should an aircraft use to turn onto a radial from the 15 DME arc at 180 KTAS?

$$\text{The turn radius is: } \frac{180}{60} = 3 \text{ nm}$$

$$\text{The lead point in degrees is: } \frac{3 \text{ NM} \times 60}{15} = 12^\circ$$

Bank angle required to maintain an arc.

On close-in arcs, constant bank angle may be necessary to stay on the arc. There are two methods to compute the required bank angle.

$$\text{Required bank angle} = \frac{\text{Turn Radius} \times 30}{\text{Arc}}$$

$$\text{Required bank angle} = \frac{1}{2} \text{ the lead for an arc to radial intercept}$$

Example: If the required lead point for an arc to radial intercept is 16°, then 8° of bank is required to maintain the arc.

Teardrop penetrations.

The only guidance usually available to fly this type of approach is just a recommended turn altitude and a "remain within" distance. It would be helpful to be able to compute a distance to go outbound so that a 30° bank turn will leave you on course inbound or, if a turn point is depicted or you choose to go further outbound to lessen the descent gradient, what bank angle is needed to roll out on course inbound. Examples 1 and 2 illustrate these two problems.

(a) Outbound distance for a 30° turn:

$$\frac{\text{Turn Radius} \times 120}{\# \text{ of degrees between radials}}$$

(b) Bank angle required for the teardrop turn (when 30° will not work):

$$\frac{TR \times 60}{\text{distance between radials}}$$

Teardrop entry for holding.

This is the same formula as above but "distance outbound" and "degrees between radials" have been switched. Leg length (distance outbound) is the known value and you have to solve for offset (degrees between radials).

$$\frac{\text{Turn Radius} \times 120}{\text{Leg Length}} = \text{Offset Heading}$$

Example: Holding pattern with 10 NM legs. TAS is 240 knots.

$$\text{Turn Radius} = \frac{(240)}{60} - 2 = 2$$

$$\frac{2 \times 120}{10} = 24^\circ \text{ offset}$$

VDP calculations

On non-USAF designed approach plates a VDP is not always published. Compute it for your desired glide slope, usually 3° (300 Ft/NM) or 2½° (250 Ft/NM).

$$\frac{\text{HAT}}{\text{Desired gradient}} = \text{VDP in NM from end of runway}$$

## SUMMARY OF 60:1 RULES AND FORMULAS

### CLIMBS AND DESCENTS

The 60:1 Rule:

$$1^\circ = 1 \text{ NM at } 60 \text{ NM}$$

$$1^\circ = 100 \text{ FT at } 1 \text{ NM}$$

Climb and Descent Gradients:

$$\text{Required gradient (FT/NM)} = \frac{\text{altitude to lose (or gain)}}{\text{distance to travel}} \quad \text{Pitch change} = \frac{\text{gradient}}{100} \quad (1^\circ \text{ pitch change} = 100 \text{ FT/NM})$$

WVI:

$$\text{WVI} = \text{Gradient (or pitch } \times 100) \times \text{TAS in minutes}$$

$$\text{WVI for a } 3^\circ \text{ glideslope} = \frac{\text{GS} \times 10}{2} \quad \text{WVI for a } 2.5^\circ \text{ glideslope} = \frac{\text{GS} \times 10 - 100}{2}$$

Determine TAS and NM/MIN:

$$\text{TAS} = \text{IMN} \times 600$$

$$\text{NM/MIN} = \text{IMN} \times 10$$

$$\text{TAS} = \text{IAS} + (\text{FL} / 2)$$

$$\text{NM/MIN} = \text{TAS} / 60$$

Steps to Determine Required Pitch and WVI (Winded Application). Mathematical steps:

$$\text{Required gradient:} \quad \text{Gradient} = \frac{\text{alt to lose}}{\text{dist to travel}}$$

$$\text{Required WVI with wind:} \quad \text{WVI} = \text{gradient} \times \text{groundspeed (NM/MIN)}$$

$$\text{Required pitch change:} \quad \text{Pitch change} = \frac{\text{required WVI}}{\text{TAS (in NM/MIN)}}$$

NOTE: For practical applications, each 60 KTS of wind will change pitch 1°.

### TURNS

$$\text{Turn Radius (TR)} \quad \text{Turn Diameter (TD)} = 2 \times \text{TR}$$

Distance to turn 90° using 30° of bank

$$\text{TR} = \text{NM/MIN} - 2$$

or

$$\text{TR} = (\text{IMN} \times 10) - 2$$

or

$$\text{TR} = \frac{(\text{NM/MIN})^2}{10}$$

or

$$\text{TR} = \text{IMN squared} \times 10$$

Distance to turn 90° using SRTs and 1/2 SRTs:

$$\text{SRT} = 1\% \text{ of TAS (or groundspeed)}$$

$$1/2 \text{ SRT} = 1/2\% \text{ of TAS (or groundspeed)}$$

Bank for Rate Turns:

$$\text{Bank for SRT} = \frac{\text{TAS}}{10} + 7$$

$$\text{Bank for } 1/2 \text{ SRT} = \frac{\text{TAS}}{20} + 7$$

Lead Point for Radial to an Arc or 90° Intercept of an Arc:

$$\text{Lead point in DME} = \text{Desired Arc} \pm \text{TR}$$

Lead Point for Arc to Radial or 90° Intercept of a Radial:

$$\text{Lead point (in degrees)} = \frac{60}{\text{Arc}} \times \text{TR (in NM)}$$

or

$$\frac{60}{\text{DME}} \times \text{TR (in NM)}$$

For Turns Less or More Than 90°, Use The Following: (These cover most situations):

| Degrees to Turn | Fraction of 90° Turn | Degrees to Turn | Fraction of 90° Turn |
|-----------------|----------------------|-----------------|----------------------|
| 180°            | 2                    | 90°             | 1                    |
| 150°            | 1 5/6                | 60°             | 1/2                  |
| 135°            | 1 2/3                | 45°             | 1/3                  |
| 120°            | 1 1/2                | 30°             | 1/6                  |

Bank Angle Required to Maintain an Arc:

$$\text{Required bank angle} = \frac{30}{\text{Arc}} \times \text{TR (Use IMN squared for TR to obtain best results)}$$

$$\text{or Required Bank angle} = \text{Radial Lead Point} / 2$$



### HOLDING

Teardrop Holding Calculations:

$$\text{Offset in degrees} = \frac{\text{TD} \times 60}{\text{outbound distance}} \quad \text{or} \quad \frac{\text{TR} \times 120}{\text{outbound distance}}$$

Timing:

$$\leq 14,000 = 1+00 \quad \quad \quad > 14,000 = 1+30$$

Outbound Correction for Inbound:

$$1+00 \text{ Correction} = 3600 / \text{inbound time} = \text{outbound time}$$

$$1+30 \text{ Correction} = 8100 / \text{inbound time} = \text{outbound time}$$

Drift calculation:

$$\text{Drift} = \frac{\text{Crosswind Component}}{\text{NM/MIN of TAS}} \quad \quad \quad 180^\circ \text{ turn} = \frac{1\% \text{ TAS}}{2}$$

$$\text{Ex. } 240 \text{ TAS} = 2.4 / 2 = 1.2 \text{ Min} = 1+12$$

Double Drift:

Into wind turn = 30° bank - 1° for every deg of drift      Other Turn = 30° bank  
 Inbound to fix = course heading ± drift      Outbound leg = outbound heading ± ( drift X 2)

Hold double drift for same amount of time as the time in 180° turn

Triple drift:

Into Wind Turn = 30° bank      Other Turn = 30° bank  
 Inbound to fix = Course heading ± drift      Outbound leg = outbound heading ± ( drift X 3)

Hold triple drift for same amount of time as the time in 180° turn

### APPROACH

Teardrop Penetration Calculation:

Determine outbound distance for 30° bank turn:

$$\text{Outbound distance} = \frac{\text{TD} \times 60}{\text{Degrees Between Radials}} \quad \text{or} \quad \frac{\text{TR} \times 120}{\text{Degrees Between Radials}}$$

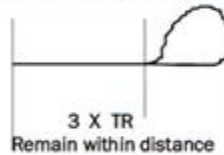
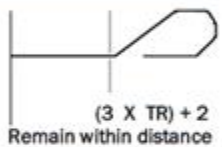
Determine bank angle required for teardrop penetration (When 30° bank will not work):

$$\text{Bank Angle} = \frac{\text{TR} \times 60}{\text{Distance Between Radials in NM}}$$

Procedure Turn Calculations:

$$45/180 \text{ Maneuver distance} = (3 \times \text{TR}) + 2$$

$$80/260 \text{ Maneuver distance} = 3 \times \text{TR}$$



VDP Calculation:

$$\text{VDP ( in NM ) From the end of the runway} = \frac{\text{HAT}}{\text{Gradient ( normally 300 )}}$$

$$\text{VDP ( in timing) From the FAF} = (\text{FAF to End of runway Distance}) - \frac{\text{HAT}}{\text{Gradient ( normally 300 )}} = \text{FAF to VDP Dist (NM)}$$

$$\frac{\text{Timing to MAP ( From timing box) }}{\text{NM from FAF to MAP}} = \text{Seconds per Mile} \quad \text{or} \quad \frac{60}{(\text{TAS} / 60)} = \text{Seconds per Mile}$$

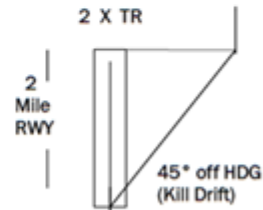
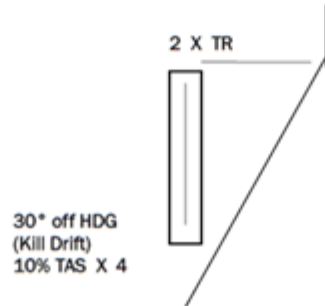
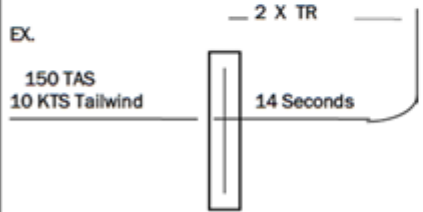
$$(\text{Seconds per Mile}) \times \text{FAF to VDP Dist (NM)} = \text{Time ( in Seconds )}$$

### CIRCLE

Perpendicular to Runway  
Timing passing runway =  
10% TAS (corrected for winds)  
(TAS + headwind - tailwind component)  
(Yes, subtract tailwind to counteract  
it "pushing you across the ground")

Displacement using 45° rule  
Turn 45° off RWY HDG  
(Kill Drift)  
Displace using Runway

Displacement using 30° rule  
Turn 30° off RWY HDG  
(Kill Drift)  
Time for 10% TAS X 4

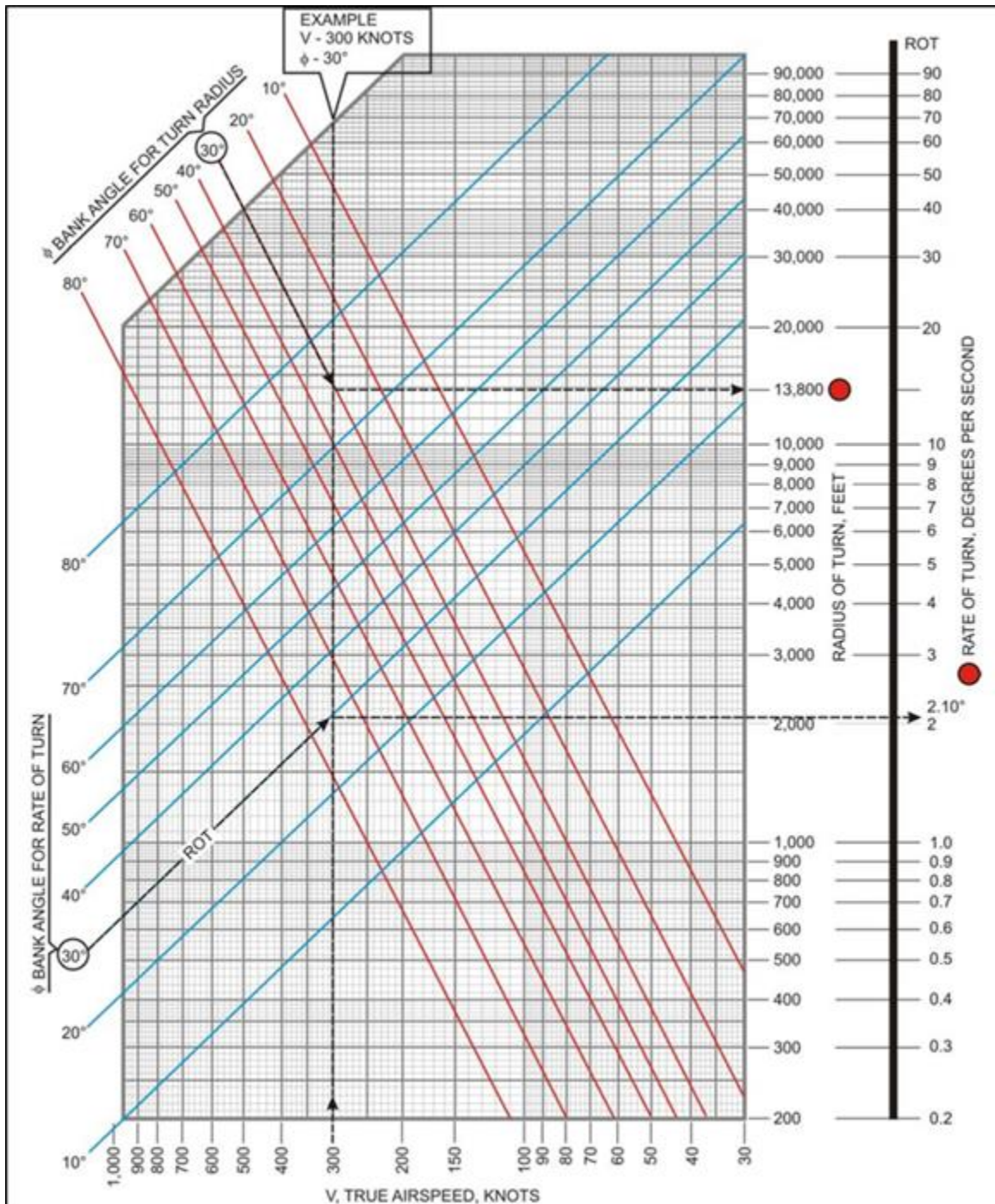


NOTE: If 2 X TR = 2 MI  
then displace down  
a 2 MI RWY as depicted



Attachment 3

GENERAL TURNING PERFORMANCE (CONSTANT ALTITUDE, STEADY TURN)



## Attachment 4

### INSTRUMENT FLYING FUNDAMENTALS

**A4.1. General.** [FAA-H-8083-15, Chapter 6; FAA-H-8083-25, Chapter 3] Instrument flying is defined as the control of an aircraft's spatial position by using instruments rather than outside visual references (**Figure A4.1**). Aircraft are equipped with analog, digital, mechanical, electronic, or a combination of instruments. Proper interpretation of aircraft instruments in instrument flight provides essentially the same information as outside visual references when in visual flight. Aircraft instrumentation falls into three broad categories: control, performance, and navigation.

**Figure A4.1. Attitude Instrument Flying.**



A4.1.1. Control instruments display immediate attitude and power changes and are calibrated to permit adjustments in precise increments (**Figure A4.2**). Control instruments do not indicate aircraft speed or altitude; refer to performance instruments to determine aircraft performance. Reference to attitude and power indicators determines aircraft control.

A4.1.1.1. The AI displays an aircraft's orientation to the Earth's horizon in its pitch and roll axes.

A4.1.1.2. Power indicators vary between aircraft; they may include manifold pressure, tachometers, fuel flow, engine pressure ratio, etc.

**Figure A4.2. Control Instruments.**

A4.1.2. Performance instruments indicate the aircraft's actual performance. Performance is determined by reference to the altimeter, airspeed or Mach indicator, vertical velocity indicator (VVI), heading indicator, angle of attack indicator, and turn and slip indicator (Figure A4.3). Performance instruments most directly reflect a change in acceleration, which is defined as change in velocity or direction; these instruments indicate if the aircraft is changing airspeed, altitude, or heading, which are horizontal, vertical, or lateral vectors.

**Figure A4.3. Performance Instruments.**

A4.1.3. Navigation instruments indicate the position of the aircraft in relation to a selected navigation facility, fix, or waypoint. This group of instruments includes various course indicators, range indicators, glideslope indicators, and bearing pointers. Aircraft with more technologically advanced instrumentation provide blended information giving the pilot more accurate positional information. Navigation instruments are comprised of indicators that display navigation information from various ground-based and space-based navigation aids (NAVAID) such as very high frequency (VHF) omni-directional range (VOR), tactical air navigation system (TACAN), non-directional beacon (NDB), instrument landing system (ILS), DME, GNSS, and other navigation information. These instruments also enable a pilot to maneuver an aircraft along a predetermined path in two or three dimensions relative to ground-based or space-based navigation facilities.

**A4.2. Control and Performance Method.** Aircraft performance is achieved by controlling the aircraft attitude and power. A pilot accomplishes instrument flight by controlling an aircraft's attitude and power to produce controlled and stabilized flight without reference to a visible horizon. This overall process is known as the "control and performance" method of instrument flying. The control and performance method is applied through the use of control, performance, and navigation instruments, resulting in a smooth flight from takeoff to landing.

A4.2.1. The control and performance method has four procedural steps:

A4.2.1.1. Establish an attitude and power setting on the control instruments that results in the desired performance.

A4.2.1.2. Trim (i.e., fine tune the control surfaces) the aircraft until control pressures are neutralized. Trimming for hands-off flight is essential for smooth, precise aircraft control. It allows a pilot to attend to other flight deck duties with minimum deviation from the desired altitude.

A4.2.1.3. Cross-check the performance instruments to determine if the established attitude or power setting is providing the desired performance. The cross-check involves both seeing and interpreting. Determine the magnitude and direction of adjustment required to achieve the desired performance if a deviation is noted.

A4.2.1.4. Adjust the attitude, power setting, or both on the control instruments as necessary.

A4.2.2. Proper control of aircraft attitude results from proper use of the AI, knowing when to change the attitude, and smoothly changing the attitude a precise amount. The AI provides an immediate, direct, and corresponding indication of any change in aircraft pitch or bank attitude.

A4.2.2.1. Changing the "pitch attitude" of the aircraft symbol by precise amounts in relation to the artificial horizon makes pitch changes. These changes are measured in degrees or bar widths depending on the type of AI. The amount of deviation from the pilot's desired performance determines the magnitude of the correction.

A4.2.2.2. Changing the "bank attitude" of the aircraft symbol by precise amounts in relation to the bank scale makes bank changes. The bank scale is normally graduated at 0 degrees, 10 degrees, 20 degrees, 30 degrees, 60 degrees, and 90 degrees and may be located at the top or bottom of the AI. Bank angles used for instrument turns are normally the desired number of degrees to turn not to exceed 30 degrees (e.g., 20 degrees of bank for a 20 degree turn, 30 degrees of bank for a 30 degree turn, 30 degrees of bank for a 90 degree turn).

A4.2.3. Proper power control is the result of smoothly establishing or maintaining desired airspeeds in coordination with attitude changes. Power changes are made by throttle adjustments while referencing power indicators. Power indicators are not affected by factors such as turbulence, improper trim, or inadvertent control pressures. Experience in an aircraft teaches a pilot approximately how far to move the throttle(s) to change the power a given amount. Knowledge of approximate power settings, cross-checking the power indicator(s), and then fine tuning prevents fixating on performance instruments and over-controlling power.

**A4.3. Trim.** An aircraft is correctly trimmed when it is maintaining a desired attitude with all control pressures neutralized. A pilot can devote more attention to navigation instruments and



additional flight deck duties when the aircraft is properly trimmed. An improperly trimmed aircraft requires constant control pressures, produces tension and fatigue, distracts attention from cross-checking, and contributes to abrupt and erratic attitude control. The pressures felt on the controls should be only those applied while controlling the aircraft.

A4.3.1. An airplane is placed in trim by:

A4.3.1.1. Applying control pressure(s) to establish a desired attitude. Then, the trim is adjusted so that the airplane maintains the desired attitude when the pilot releases the flight controls. The aircraft is trimmed for coordinated flight by centering the ball of the turn-and-slip indicator.

A4.3.1.2. Changes in attitude, power, or airspeed may require trim adjustments. Use of trim alone to establish a change in attitude usually results in erratic control. Smooth and precise attitude changes are best achieved through a combination of control pressures and subsequent trim adjustments.

A4.3.2. A helicopter is placed in trim by continually cross-checking the instruments and performing the following:

A4.3.2.1. Use the cyclic-centering button if the helicopter is so equipped; this relieves all possible cyclic pressures.

A4.3.2.2. Use the pedal adjustment to center the ball of the turn indicator. Pedal trim is required during all power changes and is used to relieve all control pressures held after a desired attitude has been achieved.

A4.3.2.3. Adjust the pitch attitude as airspeed changes to maintain desired attitude for the maneuver being executed. Adjust the bank to maintain a desired rate of turn; use the pedals to maintain coordinated flight. Adjust the trim as control pressures indicate a change is needed.

**A4.4. Instrument Cross-Check.** The first fundamental instrument flying skill is cross-checking (also called “scanning” or “instrument coverage”). Cross-checking is the continuous and logical observation of instruments for attitude, performance, and navigation information. The “hub and spoke” method is the recommended cross-check technique. A pilot spends 80 to 90 percent of the flight time looking at the AI (i.e., the “hub”) and takes quick glances at the other instruments (i.e., the “spokes”). In general, the cross-check progresses from the AI, out to another instrument, back to the AI and then out again ([Figure A4.4](#)).

**Figure A4.4. “Hub and Spoke” Cross-check.**



**A4.5. Common Instrument Cross-Check Errors.** A beginner might cross-check too rapidly, looking at the instruments without knowing exactly what to look for. Pilots learn what to look for, when to look for it, and what corrections to make with increased experience in basic instrument maneuvers and familiarity with the instrument indications associated with these maneuvers. As proficiency increases, a pilot cross-checks primarily from habit, suiting scanning rate and sequence to the demands of the flight situation. Failure to maintain basic instrument proficiency through practice can result in many of the following common scanning errors, both during training and at any subsequent time.

A4.5.1. Fixating, or staring at a single instrument, is a common and dangerous error. For example, if one flight parameter, (e.g., altitude) is frequently wandering, the pilot may devote too much time to the corresponding performance instrument (e.g., altimeter) and lose track of other critical parameters (e.g., attitude). While fixated on the instrument, increasing tension may be unconsciously exerted on the controls, which leads to an unnoticed change that may lead to more errors.

A4.5.2. Omission of an instrument from the cross-check, may be caused by failure to anticipate significant instrument indications. For example, if the pilot neglects to check the heading indicator for constant heading information when straight-and-level flight is established with reference only to the AI during a roll-out from a 180 degree steep turn. Because of precession error, the AI temporarily shows a slight error, correctable by quick reference to the other flight instruments.

A4.5.3. Emphasis on a single instrument, instead of the combination of instruments necessary for attitude information, is an understandable fault during the initial stages of training. It is a natural tendency to rely on the instrument that is most readily understood, even when it provides erroneous or inadequate information. Reliance on a single instrument is a poor

technique. For example, a pilot can maintain reasonably close altitude control with the AI but cannot hold altitude with precision without including the altimeter in the cross-check.

**A4.6. Instrument Interpretation.** The second fundamental skill, instrument interpretation, requires more thorough study and analysis. It begins by understanding each instrument's construction and operating principles. Then, this knowledge is applied to the performance of the aircraft being flown, the maneuvers to be executed, the cross-check and control techniques applicable to that aircraft, and the flight conditions.

A4.6.1. As the performance capabilities of the aircraft are learned, a pilot interprets the instrument indications appropriately in relation to the attitude of the aircraft.

A4.6.2. If the pitch attitude is to be determined, the airspeed indicator, altimeter, VVI, and AI provide the necessary information.

A4.6.3. If the bank attitude is to be determined, the heading indicator, turn coordinator, and AI provide the necessary information.

A4.6.4. For each maneuver, the pilot learns what performance to expect and the combination of instruments to be interpreted to control aircraft attitude during the maneuver.

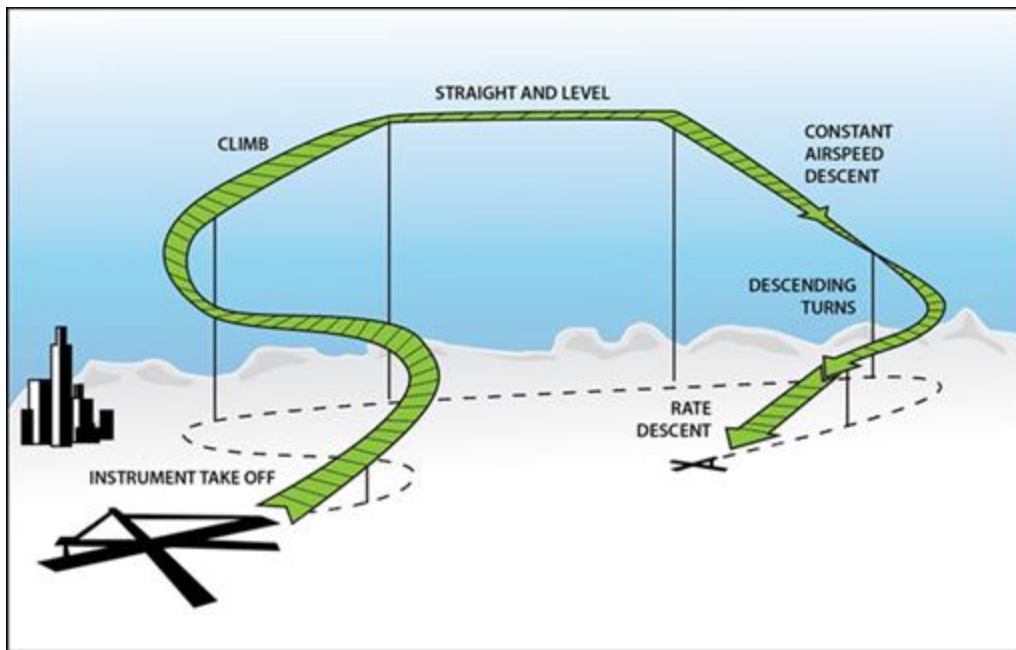


## Attachment 5

## INSTRUMENT MANEUVERS

**A5.1. General.** [FAA-H-8083-15, Chapter 7 (Fixed Wing)/Chapter 8 (Helicopter)] Pilots most commonly use the maneuvers in this chapter during instrument flight (**Figure A5.1**). A high level of proficiency employing these maneuvers is necessary to operate safely in instrument conditions. Additional maneuvers may be required for specific training requirements or helicopter operations; refer to applicable sections of the aircraft flight manual for detailed information.

**Figure A5.1. Typical Instrument Flight.**



**A5.2. Instrument Takeoff.** [FAA-H-8083-15, Chapter 7] Accomplish the instrument takeoff by referring to both outside visual references and the flight instruments. The amount of attention given to each reference varies depending on the existing weather conditions. Instrument takeoff procedures and techniques are invaluable aids at night, toward and over water or desolate areas, and during periods of reduced visibility. Immediately transition to instrument references any time disorientation is suspected or when outside visual references become unreliable.

**A5.3. Instrument Navigation.** [FAA-H-8083-15, Chapter 9] Understanding navigation systems provides the framework for all instrument procedures. FAA-H-8083-15 provides background information for course intercept, maintaining course, station passage, and arc/radial intercept.

A5.3.1. For VOR and VOR/DME navigation, station passage occurs when the TO-FROM indicator makes the first positive change indicating FROM.

A5.3.2. For TACAN navigation, station passage occurs when the range indicator stops decreasing.

A5.3.3. For ADF navigation, station passage occurs when the bearing pointer passes 90 degrees to the inbound course. **Note:** When established in an NDB holding pattern, subsequent

station passage occurs at the first definite move by the bearing pointer through the 45-degree index on the indicator.

**A5.4. Proceeding Direct.** Pilots will not file a flight plan nor accept a clearance that requires an aircraft to navigate direct to a fix (i.e., radial/DME or radial/radial) unless the primary navigation equipment onboard the aircraft is certified for the appropriate area navigation capability. **(T-0)**. Pilots of aircraft without the appropriate area navigation capability will reply with “unable” when given a clearance to proceed direct to a fix. **(T-0)**. ATC should provide radar vectors or an alternate routing under these circumstances.

**A5.5. Instrument Flying Maneuvers.** Detailed descriptions of instrument flying maneuvers may be found in FAA-H-8083-15.

A5.5.1. Climbing and descending maneuvers can be performed as constant airspeed or constant rate. The constant airspeed maneuver is accomplished by setting power and varying pitch to maintain a specific airspeed. The constant rate maneuver is accomplished by varying both pitch and power to maintain a specific airspeed and vertical velocity. Either type of climb or descent may be performed while maintaining a constant heading or while turning and should be practiced at airspeeds, configurations, and ascent or descent rates used in actual instrument flight.

A5.5.1.1. Most aircraft have a standard set of pitch and power settings for certain airspeeds and configurations. For instance, to maintain 300 knots in a clean configuration, an aircraft might require 10 degrees nose down pitch at idle power. A pilot might also know that for that aircraft, each degree of pitch change at a constant power setting and configuration changes the airspeed 10 knots.

A5.5.1.2. To perform a constant airspeed climb or descent, make a smooth and simultaneous change in pitch and power corresponding to the desired airspeed and configuration. Once the initial attitude is established, fine-tune the airspeed by adjusting pitch. Confirm the pitch change by noting a change on the VVI and wait for the airspeed to stabilize. Continue this process until the desired airspeed is attained.

A5.5.1.3. Rate climbs and descents are like constant airspeed climbs and descents but require a constant VVI. An effective instrument cross-check and minor power adjustments allow a pilot to fine-tune the descent profile.

A5.5.2. Straight and level un-accelerated flight consists of maintaining desired altitude, heading, and airspeed.

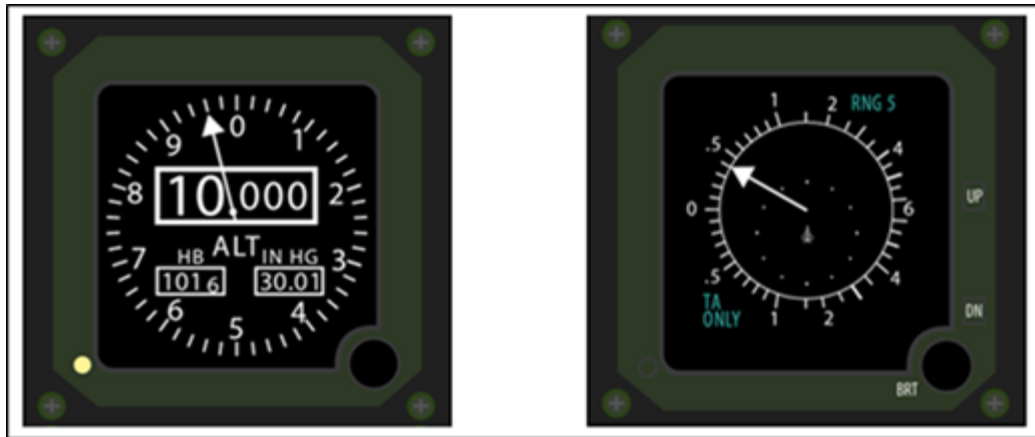
A5.5.2.1. Maintain altitude by setting a specific pitch on the AI that maintains the desired altitude. As airspeed decreases, a higher pitch attitude is required to maintain altitude due to the loss of lift. Conversely, higher airspeeds require lower pitch attitudes. Each aircraft has basic pitch and power settings to maintain altitude and airspeed which may change slightly with changes in atmospheric conditions.

A5.5.2.2. While maintaining altitude, continue the instrument cross-check. If the altimeter or VVI indicate an altitude deviation, a pitch change is necessary. For small deviations, use control pressure rather than movement to make smooth and small pitch changes. Use trim to reduce control forces once the desired pitch is set. This allows the performance instruments time to display the new parameter before making an additional correction.

Common errors include “chasing” the VVI and making erratic or large control inputs. Make another small and smooth pitch correction on the AI to level off. The attitude should be slightly different than the original pitch setting held when the altitude deviation occurred.

A5.5.2.3. When making pitch corrections, a VVI one to two times the amount of the altitude deviation prevents overshoots (e.g., if 100 feet off altitude, set a pitch that produces a 100 to 200 foot per minute climb or descent on the VVI). Approaching the desired altitude, begin the pitch change to level off at approximately 10% of the vertical rate. (Figure A5.2).

Figure A5.2. Leading the Level Off.



A5.5.2.4. Maintaining a desired heading is accomplished by maintaining a zero-bank attitude in coordinated flight. If a heading deviation occurs, make a smooth bank change on the AI to return to the desired heading. As a guide, the bank attitude change on the AI should equal the heading deviation in degrees, not to exceed 30 degrees (e.g., if the heading deviation is 10 degrees, then use 10 degrees of bank). At higher true airspeeds, a larger bank may be needed to prevent an excessive course deviation. **Note:** If maintaining zero bank attitude on the AI and the heading changes, the AI may be “precessing”. Confirm this by referencing backup AIs. If precession is noted, it may be necessary to transition to the backup AI depending on the severity of the precession.

A5.5.2.5. Maintain airspeed by referring to the airspeed or Mach indicator and adjust the power, drag devices (for large airspeed changes), or aircraft attitude. Known pitch and power settings required for desired airspeed and attitude aid in determining adjustments. An effective instrument cross-check indicates if subsequent power adjustments are required after establishing the approximate initial power setting. **Note:** An airspeed deviation may be the result of a pitch change, not an incorrect power setting (Figure A5.3). Check all other flight parameters when an airspeed deviation occurs. Conversely, if in level flight and a power change is necessary to correct airspeed, the new power setting or the employment of drag devices coupled with a change in airspeed may induce a climb or descent and require an attitude correction to maintain level flight. This relationship between airspeed and aircraft attitude requires an effective instrument cross-check.

Figure A5.3. Airspeed Deviation.



A5.5.3. The pitch, bank, and power principles discussed in maintaining straight and level flight apply while performing level turns ([Figure A5.4](#)). Performing a level turn requires an understanding of several factors: entering the turn; maintaining bank, altitude, and airspeed during the turn; and returning to level flight. A “standard rate turn” is defined as a rate at which the aircraft makes a 360 degree turn in 120 seconds.

A5.5.3.1. To prevent heading overshoots, for heading changes of less than 30 degrees, the bank angle should equal the number of degrees to be turned. For heading changes of more than 30 degrees, use a bank angle of 30 degrees. Instrument procedures, high airspeeds, flight manual procedures, or airspace may require other angles of bank. Helicopters should use no more than standard rate turns (15 degrees to 20 degrees) when operating between 80 and 120 knots.

A5.5.3.2. To enter a turn, refer to the AI while applying smooth and coordinated control pressures to establish the desired angle of bank. It is normally necessary to increase pitch slightly to counteract the loss of vertical lift due to the bank. The increased pitch in prolonged turns requires consistent back pressure on the elevator control. Trimming off the pressure on the elevator aids in smooth aircraft control and enhance cross-check capability in the turn. Additionally, to maintain airspeed, an increase in power is required to counteract the induced drag produced by the elevator inputs. The bank, pitch change and power increase should all be applied smoothly as the aircraft enters the turn to prevent the need for large corrections during the turn.

Figure A5.4. Level Turns.



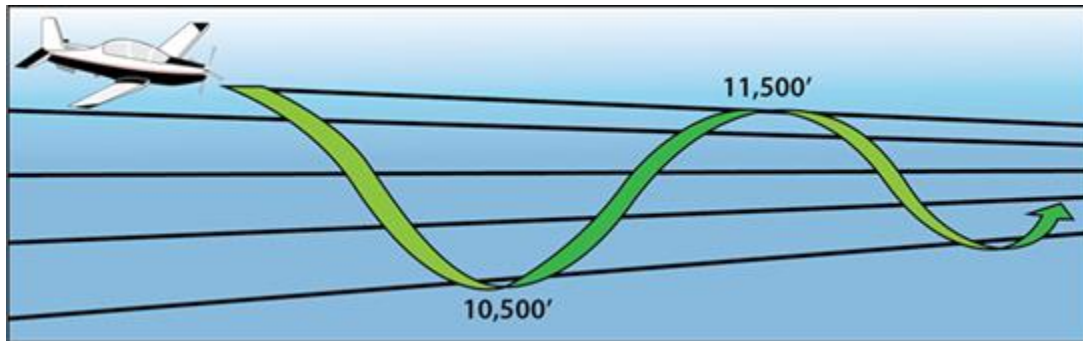
A5.5.3.3. To roll out on a desired heading, calculate a lead point that is approximately one-third the angle of bank used in the turn (e.g., if making a 30 degrees bank turn, begin roll out at 10 degrees of heading prior to the desired final heading). Upon reaching the lead point, smoothly and simultaneously reverse the bank, pitch, trim, and power inputs used to roll into the turn. Once on the new heading, check for deviations from straight and level flight and apply corrections as needed.

A5.5.4. Steep turns are normally defined as any turn greater than 30 degrees of bank and are practiced in simulated instrument conditions. The control inputs for steep turn entry and exit are identical to a normal turn except all inputs are more pronounced. The increased bank requires more pitch, more back pressure, and more power to counteract the further reduced vertical lift and increased induced drag. The rate of turn is much faster in a steep turn and requires a more aggressive lead point. For helicopters, any rate greater than standard is considered a steep turn; most helicopters practice steep turns using 30 degrees of bank, which is the maximum angle of bank recommended under instrument conditions.

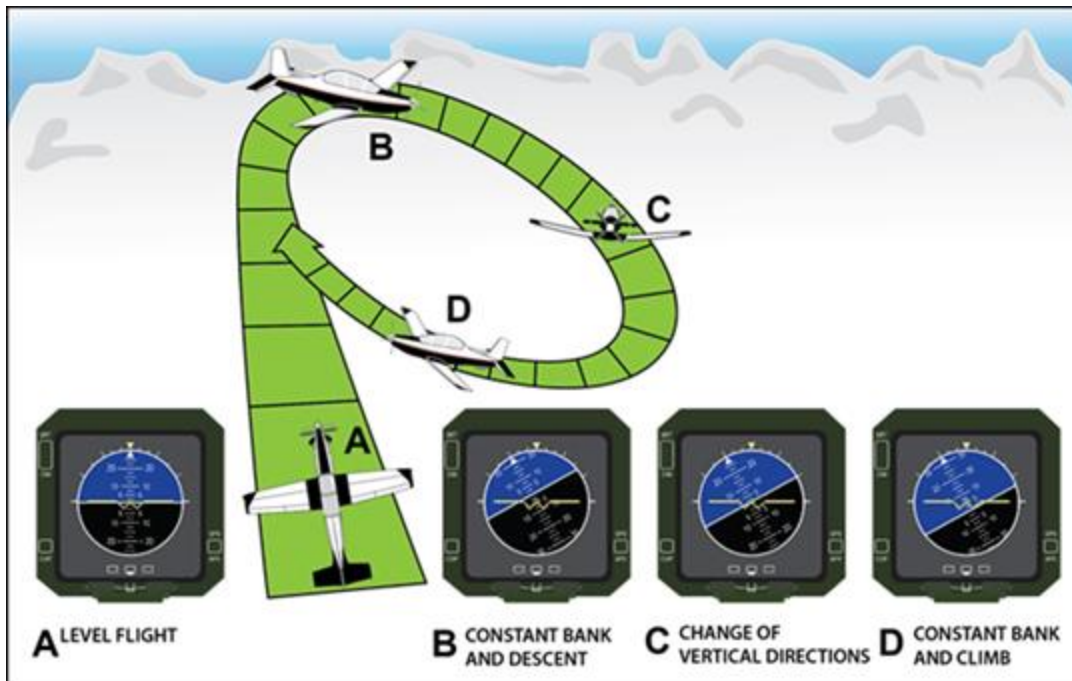
**A5.6. The “Vertical S”.** The “Vertical S” maneuvers are proficiency maneuvers designed to improve cross-check and aircraft control necessary for the different phases of instrument flight. Each may be flown utilizing various configurations, airspeeds, rates, etc.

A5.6.1. The “Vertical S Alpha” is a continuous series of rate climbs and descents flown on a constant heading utilizing a vertical velocity compatible with aircraft performance ([Figure A5.5](#)).



**Figure A5.5. Vertical S Alpha.**

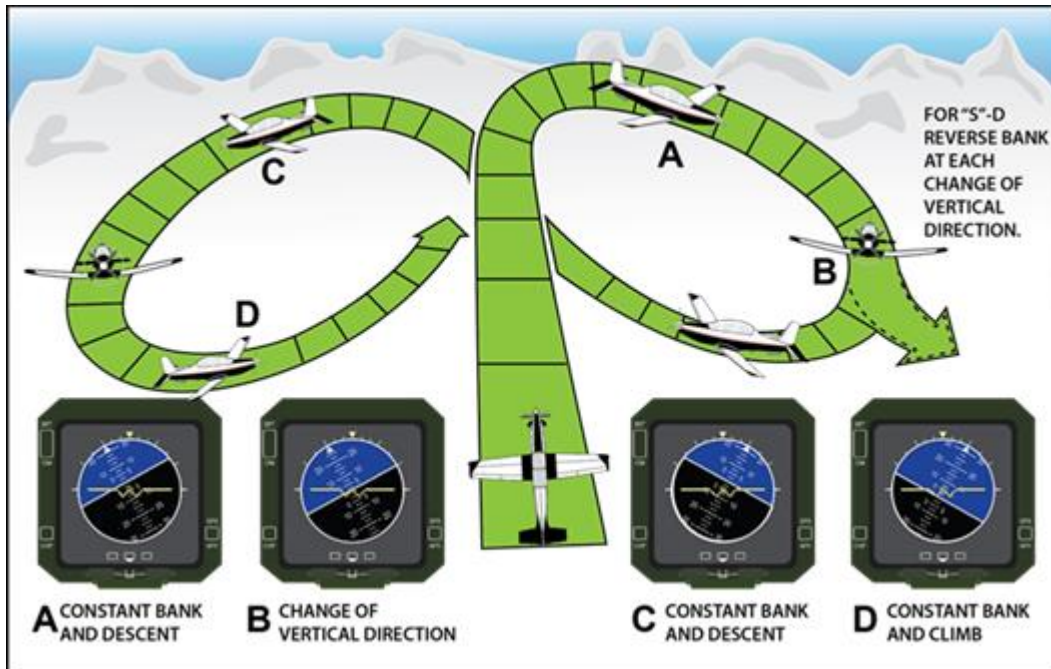
A5.6.2. The “Vertical S Bravo” is the same as the Vertical S Alpha except that a constant angle of bank is maintained during the climb and descent (**Figure A5.6**). The angle of bank used should be compatible with aircraft performance (e.g., usually that required for a normal turn). The turn is established simultaneously with the initial climb or descent.

**Figure A5.6. Vertical S Bravo.**

A5.6.3. The “Vertical S Charlie” is the same as Vertical S Bravo, except that the direction of turn is reversed at the beginning of each descent (**Figure A5.7**). Enter the Vertical S Charlie in the same manner as the Vertical S Bravo.

A5.6.4. The “Vertical S Delta” is the same as the Vertical S Charlie, except that the direction of turn is reversed simultaneously with each change of vertical direction (**Figure A5.7**). Enter the Vertical S Delta in the same manner as the Vertical S Bravo or Charlie.

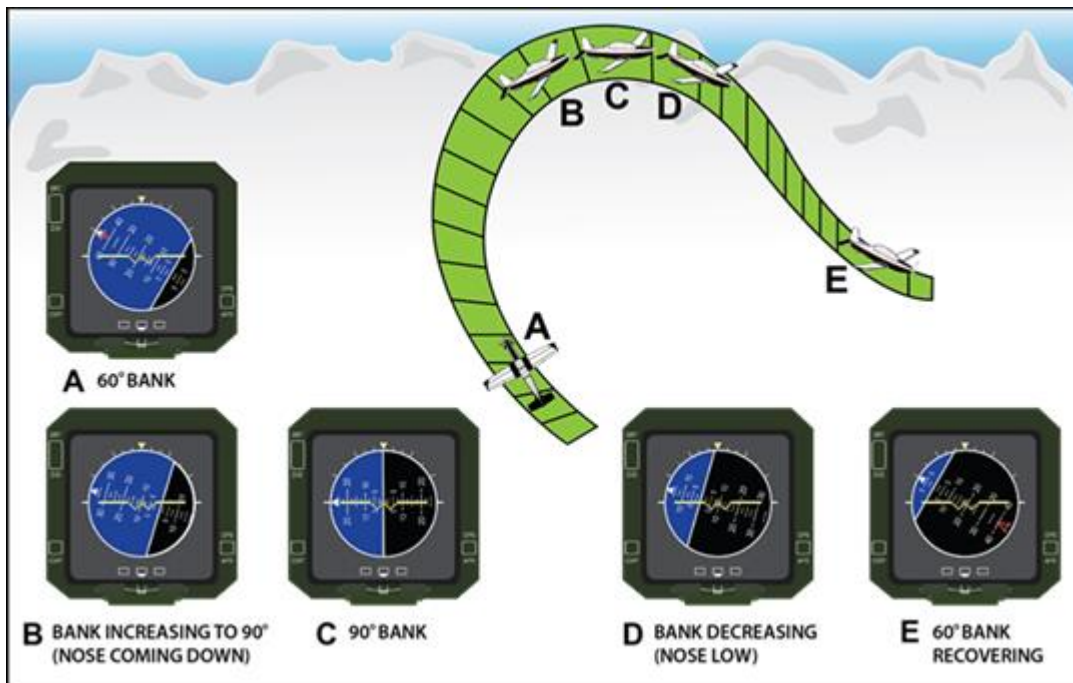
Figure A5.7. Vertical S Charlie and Delta.



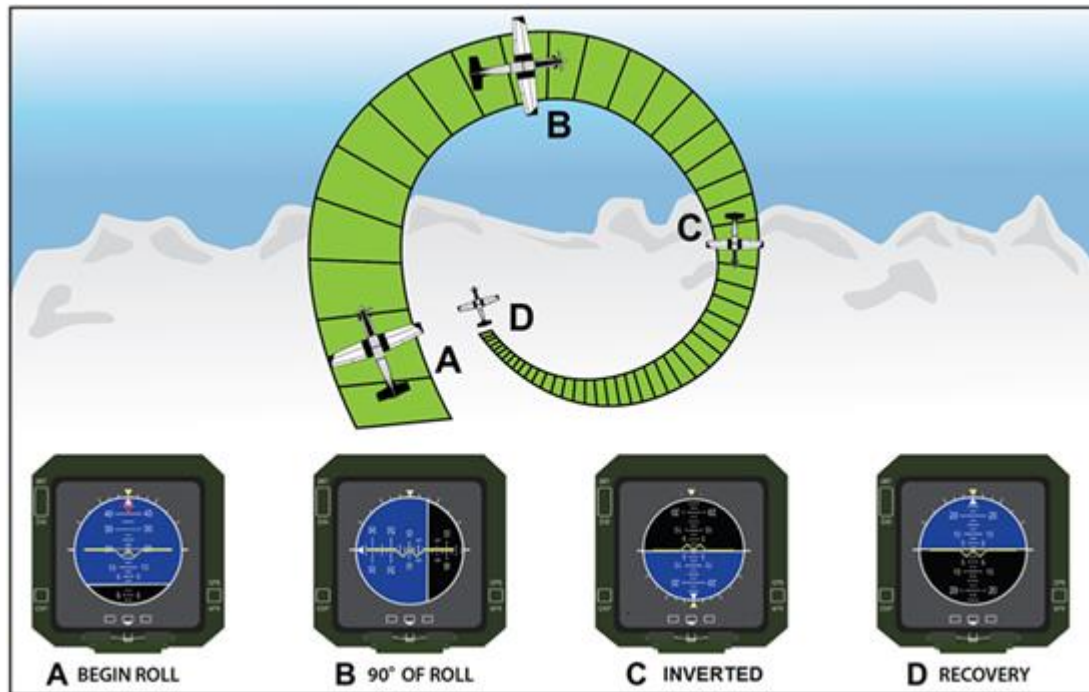
**A5.7. Wingover.** Begin the wingover maneuver from straight and level flight ([Figure A5.8](#)). After obtaining the desired airspeed, start a climbing turn in either direction while maintaining the wing tip of the miniature aircraft on the horizon bar until reaching 60 degrees of bank. Allow the nose of the aircraft to start down while continuing to increase the angle of bank, planning to arrive at 90 degrees of bank as the fuselage dot of the miniature aircraft reaches the horizon bar. Begin decreasing the angle of bank as the fuselage dot of the miniature aircraft reaches the horizon bar so that the wing tip of the miniature aircraft reaches the horizon bar as 60 degrees of bank is reached. Maintain the wing tip on the horizon bar while rolling to a wings level attitude. The rate of roll during the recovery should be the same as the rate of roll used during the entry. Control pitch and bank throughout the maneuver by reference to the AI.



Figure A5.8. Wingover.



**A5.8. Aileron Roll.** Begin the aileron roll maneuver from straight and level flight ([Figure A5.9](#)). After obtaining the desired airspeed, smoothly increase the pitch attitude with the wings level 15 degrees to 25 degrees nose up on the AI. Start a roll in either direction and adjust the rate of roll so that, when inverted, the wings are level as the fuselage dot of the miniature aircraft passes through the horizon bar. Continue the roll and recover to level flight. The entire maneuver should be accomplished by reference to the AI. Use sufficient back pressure to maintain normal seat pressures throughout the maneuver.

**Figure A5.9. Aileron Roll.**

**A5.9. Unusual Attitudes.** An unusual attitude is an aircraft attitude which occurs inadvertently, is not normally required for instrument flight, or is not anticipated.

A5.9.1. Immediately transition to instrument references if disoriented or when outside visual references become unreliable. Recognizing an unusual attitude is critical to a successful recovery.

A5.9.2. Recognize an unusual attitude in one of two ways – an unusual attitude “picture” on the AI or unusual performance on the performance instruments.

A5.9.3. Confirm that an unusual attitude exists by comparing control and performance instrument indications prior to initiating recovery on the AI. This precludes entering an unusual attitude because of correcting for erroneous instrument indications. Use additional independent attitude indicating sources (e.g., standby AI, copilot’s AI) to verify the actual aircraft attitude. If there is any doubt as to proper AI operation, then recover using AI inoperative procedures.

A5.9.4. The recovery actions should be compatible with the severity of the unusual attitude, the characteristics of the aircraft, and the altitude available for the recovery. The following aerodynamic principles and considerations are applicable to the recovery from unusual attitudes:

A5.9.4.1. Reducing bank in a dive or increasing bank in a climb aids pitch control.

A5.9.4.2. Power and drag devices used properly aid airspeed control if the aircraft flight manual allows their use in unusual attitude situations.

A5.9.4.3. During unusual attitude recoveries, unless necessary to avoid a greater emergency, ensure bank and power do not exceed aircraft limitations.

A5.9.4.4. For AI with a bank pointer and bank scale at the top, the bank pointer that is always aligned above and perpendicular to the surface of the earth is considered a sky pointer. Rolling towards the sky pointer to place it in the upper half of the case corrects an inverted attitude.

A5.9.4.5. For AI with the bank scale at the bottom, rolling in the direction that places the pitch reference scale right side up corrects an inverted attitude.

A5.9.5. Night vision devices (NVD) may be distracting during unusual attitude recoveries. Once transition to instruments has occurred, do not rely on outside NVD cues until the aircraft is recovered.

A5.9.6. Spatial disorientation may become severe during the recovery from an unusual attitude with an inoperative AI. Unusual attitudes may result in excess loss of altitude and possible loss of aircraft control.

A5.9.7. Due to limited attitude information, recovery from unusual attitudes using a HUD or helmet mounted display may be difficult or impossible.

**A5.10. Fixed-wing Unusual Attitudes – AI Operative.** For fixed-wing aircraft, use the following procedures if specific unusual attitude recovery procedures are not in the flight manual:

A5.10.1. If diving, adjust power and drag devices as appropriate while rolling to a wings level, upright attitude, and correct pitch to level flight on the AI. Do not add back pressure until the aircraft is less than 90 degrees of bank.

A5.10.2. If climbing, use power and bank as necessary to assist pitch control and avoid negative loads on the aircraft. As the AI airplane symbol approaches the horizon bar, adjust bank, power, and pitch to complete recovery and establish the desired aircraft attitude. Exercise care when recovering from a steep climb to avoid exceeding bank limitations.

**A5.11. Fixed-wing Unusual Attitudes – AI Inoperative.** Successful recovery from unusual attitudes depends greatly on pilot proficiency and early recognition of AI failure. AI failure should be immediately suspected if control pressures are applied without corresponding AI changes or performance instrument indications contradict the “picture” on the AI. The following procedures are recommended should an unusual attitude be encountered without any functioning AIs:

A5.11.1. If the aircraft flight manual allows and an available autopilot is not slaved to gyros of the malfunctioning AI, consideration may be given to engaging the autopilot and setting it to straight and level flight. If airspeed or vertical velocity are excessive, use the procedures below to return the aircraft to acceptable flight parameters before attempting to engage the autopilot.

A5.11.2. Determine whether the aircraft is in a climb or a dive by referring to the airspeed, altimeter, and vertical velocity indicators.

A5.11.3. If climbing, use power as required. If the airspeed is low or decreasing rapidly, pitch control may be aided by maintaining or rolling into a turn of approximately standard rate on the turn needle until reaching level flight.

A5.11.4. If diving, roll to center the turn needle and recover from the dive. Adjust power and drag devices as appropriate. Except for vertical attitudes, rolling “away” from the turn needle or turn coordinator and centering it results in an upright attitude.

A5.11.5. Upon reaching level flight, center the turn needle. The aircraft is level when the altimeter stops. The vertical velocity indicator lag error may cause it not to indicate level until the aircraft passes through level flight.

**A5.12. Helicopter Unusual Attitudes – AI Operative.** Recoveries from helicopter unusual attitudes are unique due to rotary-wing aerodynamics as well as application of the control and performance concept to helicopter flight. Application of improper recovery techniques can result in blade stall, power settling, or an uncontrollable yaw if recovery is delayed. Due to these differences, unusual attitude recoveries for helicopters are decidedly different from fixed-wing recoveries and require immediate action. Use the following guidance if specific unusual attitude recovery procedures are not contained in the aircraft flight manual:

A5.12.1. Determine whether the aircraft is in a climb, dive, or hover by referring to the airspeed, altimeter, and VVI.

A5.12.2. If climbing, consider pitch attitude and airspeed. If the inadvertent pitch attitude is not extreme (10 degrees or less from level flight), smoothly lower the miniature aircraft back to a level flight indication, level the wings, and resume a normal cross-check using power as required. For extreme pitch attitudes (above 10 degrees), bank the aircraft in the shorter direction toward the nearest 30 degrees bank index. The amount of bank used should be commensurate with the pitch attitude and external conditions, but do not exceed 30 degrees of bank in making the recovery. Allow the miniature aircraft to fall toward the horizon. When the aircraft symbol is on the horizon, level the wings and adjust the aircraft attitude to a level flight indication. Use power as necessary throughout the recovery.

A5.12.3. If diving, consider altitude, acceleration limits, and the possibility of encountering blade stall. If altitude permits, avoid rolling pullouts. To recover from a diving unusual attitude, roll to a wings level indication then establish a level flight attitude on the AI. Adjust power as necessary and resume a normal cross-check.

A5.12.4. If the aircraft is in a hover or low speed when the unusual attitude is recognized, smoothly but immediately roll to a wings level attitude and apply maximum power available. Once attitude control is reestablished, execute an instrument takeoff, or refer to hover velocity instrumentation to maintain position (if available). This condition is most common during dust or white out situations, or when performing terminal operations at night or over water.

A5.12.5. For helicopters encountering an unusual attitude resulting from blade stall, reduce collective before applying attitude corrections if the aircraft is in a climbing unusual attitude. This aids in eliminating the possibility of aggravating the blade stall condition. To aid in avoiding blade stall in a diving unusual attitude recovery, reduce power and bank attitude before initiating a pitch change. In all cases avoid abnormal positive or negative loading which could lead to additional unusual attitudes or aircraft structural damage.

**A5.13. Helicopter Unusual Attitudes – AI Inoperative.** With an inoperative AI, successful recovery from unusual attitudes depends greatly on pilot proficiency and early recognition of AI failure. For example, AI failure should be immediately suspected if control pressures are applied for a turn without corresponding AI changes or performance instrument indications that contradict the “picture” on the AI. Should an unusual attitude be encountered without an AI, the following procedures are recommended:

A5.13.1. Determine whether the aircraft is in a climb or a dive by referring to the airspeed, altimeter, and vertical velocity indicators.

A5.13.2. If climbing, use power as required. If the airspeed is low or decreasing rapidly, pitch control may be aided by maintaining a standard rate turn on the turn needle until reaching level flight. If the turn needle in a flight director system is used, center the turn needle. This is because it is very difficult to determine between a standard rate turn and full needle deflection.

A5.13.3. If diving, roll to center the turn needle and recover from the dive. Adjust power as appropriate. Disregarding vertical attitudes, rolling “away” from the turn needle and centering it results in an upright attitude.

A5.13.4. Upon reaching level flight, center the turn needle. The aircraft is level when the altimeter stops. The vertical velocity indicator lag error may cause it not to indicate level until the aircraft passes level flight.