



**AIR FORCE HANDBOOK 10-222, VOLUME 14
1 August 2008**

CIVIL ENGINEER GUIDE TO FIGHTING POSITIONS, SHELTERS, OBSTACLES, AND REVETMENTS



DEPARTMENT OF THE AIR FORCE

This Page Intentionally Left Blank

BY ORDER OF THE SECRETARY OF THE AIR FORCE AIR FORCE HANDBOOK 10-222, VOLUME 14
1 August 2008



Certified Current, 8 March 2012

Operations

***CIVIL ENGINEER GUIDE TO FIGHTING POSITIONS, SHELTERS,
OBSTACLES, AND REVETMENTS***

ACCESSIBILITY: This publication is available on the e-Publishing website at <http://www.e-publishing.af.mil> for downloading and ordering.

RELEASABILITY: There are no releasability restrictions.

OPR: HQ AFCESA/CEXX

Certified by: HQ AF/A7CX
(Colonel Donald L. Gleason)
Pages: 157

Supersedes: AFH 10-222V14, 1 November 2000

This handbook addresses expedient construction and employment of fighting positions, shelters, obstacles, and revetments in the expeditionary environment. It is designed as a reference for deployed civil engineers. The defensive measures are primarily intended for protection against conventional weapons effects. It is applicable to active duty, Air National Guard, and Air Force Reserve engineers. Refer recommended changes and questions about this publication to the Office of Primary Responsibility (OPR) using the AF IMT 847, *Recommendation for Change of Publication*; route AF Its 847 from the field through Major Command (MAJCOM) publications/forms managers. Ensure all records created as a result of processes prescribed in this publication are maintained in accordance with AFMAN 33-363, *Management of Records*, and disposed of in accordance with the Air Force Records Disposition Schedule (RDS) at <https://afrims.amc.af.mil>. The use of the name or mark of any specific manufacturer, commercial product, commodity, or service in this publication does not imply endorsement by the Air Force.

SUMMARY OF CHANGES

This publication has been substantially revised and must be completely reviewed. This revision removes obsolete force protection measures and incorporates the latest tactics, techniques, and procedures used by civil engineers to implement physical security measures in the expeditionary environment.

Preface.	10
Chapter 1—INTRODUCTION.	11
1.1. Overview.	11
Figure 1.1. Historic Earthworks.	11
1.2. The Threat.	12
Table 1.1. Typical Weapons and Their Effects.	12
Figure 1.2. Pressure-Time Curve.	13
1.3. Planning.	15
1.4. Protective Construction.	19
Figure 1.3. Protective Shelter Construction.	19
Table 1.2. Security Engineering Series of Unified Facilities Criteria.	20
Chapter 2—FIGHTING POSITIONS.	21
2.1. Overview.	21
2.2. Safety.	21
2.3. Materials.	21
Table 2.1. Checklist – Basic Criteria for Fighting Positions.	22
2.4. Hasty Fighting Positions.	23
Figure 2.1. Hasty Fighting Position.	24
2.5. Deliberate Fighting Positions.	24
Figure 2.2. One-Person Deliberate Fighting Position.	25

Figure 2.3. Outlining One-Person Fighting Position.	26
Figure 2.4. Grenade Sump – One-Person Fighting Position. ...	27
Figure 2.5. Fighting Position Revetment.	28
Figure 2.6. Reinforced Trenches.	30
Figure 2.7. Ground Shock Intercept Trenches.	30
Table 2.2. Checklist – Fighting Position Revetments and Trenches.	31
Table 2.3. Timber and Processed Lumber Comparison.	33
Figure 2.8. Placement of Roof Support Logs.	33
Table 2.4. Center-to-Center Spacing for Wood Stringers and Soil Cover to Defeat Contact Bursts.	34
Figure 2.9. Illustration of Unsupported Span and On-Center Spacing.	35
Figure 2.10. Dustproof Layer.	35
Figure 2.11. Completed Fighting Position – Side View.	36
Table 2.5. Checklist – Fighting Position Overhead Cover.	37
Figure 2.12. Two-Person Deliberate Fighting Position.	39
Figure 2.13. Grenade Sumps – Two-Person Deliberate Fighting Position. ...	40
Figure 2.14. Typical Sectors of Fire.	42
Figure 2.15. Curved Two-Person Deliberate Fighting Position.	42
Figure 2.16. Basic Machine Gun Fighting Position.	43
Figure 2.17. Top View – Three-Person Machine Gun Fighting Position. ...	44
Figure 2.18. Rear View – Three-Person Machine Gun Fighting Position. ...	44
Figure 2.19. L-Shaped Machine Gun Fighting Position.	45
Figure 2.20. Horseshoe-Shaped Machine Gun Fighting Position.	45
Figure 2.21. Mortar Position.	46

Figure 2.22. Light Antitank Weapon (LAW) Fighting Position.	47
Figure 2.23. Earth Containers Being Expanded and Filled On-site.	48
Figure 2.24. Improved Foundation.	49
Figure 2.25. First Layer – Single-Bay Fighting Position.	50
Figure 2.26. Second Layer – Single-Bay Fighting Position.	51
Figure 2.27. Composite Panels – Single-Bay Fighting Position.	51
Figure 2.28. Waterproof Membrane – Single-Bay Fighting Position.	52
Figure 2.29. Overhead Cover – Single-Bay Fighting Position.	53
Figure 2.30. Completed Single-Bay Fighting Position.	53
Chapter 3—PROTECTIVE STRUCTURES.	54
3.1. Overview.	54
Figure 3.1. Protective Structures.	54
3.2. Expedient Protective Structures.	55
Figure 3.2. Corrugated Metal Culvert Shelter.	56
Figure 3.3. Top View – Fighting Bunker.	58
Figure 3.4. Front View – Fighting Bunker.	58
Figure 3.5. Layout and Design – Fighting Bunker.	59
Table 3.1. Fighting Bunker Bill of Materials.	60
Table 3.2. Thickness of Wood to Support Earth Cover.	60
3.3. Prefabricated Structures.	61
Figure 3.6. Expandable Tactical Shelter.	61
Figure 3.7. ISO Bunker.	62
Figure 3.8. First Layer – ISO Bunker.	63

Figure 3.9. Second Layer – ISO Bunker.	64
Figure 3.10. Roof Support – ISO Bunker.	65
Figure 3.11. Sheet Piling – ISO Bunker.	66
Figure 3.12. Waterproof Membrane – ISO Bunker.	66
Figure 3.13. Overhead Cover – ISO Bunker.	67
Table 3.3. Visual Checklist – ISO Bunker.	67
3.4. Reinforced Concrete Bunkers.	68
Figure 3.14. Reinforced Concrete Bunkers.	69
Chapter 4—OBSTACLES.	70
4.1. Overview.	70
4.2. Planning.	70
4.3. Natural Obstacles.	71
Figure 4.1. Existing Barrier Complemented With Barbed Wire.	71
Table 4.1. Description of Natural Obstacles.	72
4.4. Field Expedient Obstacles.	73
Figure 4.2. Abatis.	73
Figure 4.3. Log Wall.	74
Figure 4.4. Log Hurdles.	75
Figure 4.5. Log Cribs.	76
Figure 4.6. Timber Posts.	77
Figure 4.7. Steel Angled Posts.	78
Figure 4.8. Berms and Ditches.	80
Figure 4.9. Employing Additional Obstacles With Triangular Ditch.	81

Figure 4.10. Earth-Filled Obstacles. 82

Figure 4.11. Urban Rubble. 83

Figure 4.12. Concertina Wire Roadblock. 84

Table 4.2. Installation Procedures – Concertina Wire Roadblock. 85

Table 4.3. Installation Procedures – Triple-Strand Concertina Wire Fence. 86

Figure 4.13. Picket Spacing. 87

Figure 4.14. Joining Rolls of Concertina Wire. 87

 4.5. Prefabricated Obstacles. 88

Figure 4.15. Fence Reinforced With Cable. 88

Figure 4.16. Obscuration Screen on Perimeter Fence. 89

Figure 4.17. Predetonation Screening. 90

Figure 4.18. Concrete Barriers. 91

Figure 4.19. Portable Lift Barrier. 93

Figure 4.20. Retractable Bollards. 93

Figure 4.21. Jersey Barrier. 94

Figure 4.22. Fixed Bollards. 95

Figure 4.23. Removable Posts. 96

Figure 4.24. Typical Concrete Cube and Cylinder. 97

Figure 4.25. Tetrahedrons and Dragon’s Teeth. 97

Figure 4.26. Steel Hedgehog. 98

Chapter 5—REVETMENTS. 99

 5.1. Overview. 99

Figure 5.1. Various Types of Revetments. 99

5.2. Berms.	100
Figure 5.2. Berm Height.	101
Figure 5.3. Berm Thickness.	101
Figure 5.4. Berm Slope.	102
Figure 5.5. Illustration of Berms With Varying Slopes.	103
Figure 5.6. Structurally Supported Berm.	104
Figure 5.7. Structural Support for Berms.	105
Figure 5.8. Berm Supported by Revetments.	106
Figure 5.9. Berm Supported by a Facility.	106
Figure 5.10. Berms Supported by Retaining Walls.	107
5.3. Sandbag Revetments.	108
Table 5.1. Sandbag National Stock Numbers.	108
Figure 5.11. Sandbag Revetment Close to Protected Asset.	109
Figure 5.12. Sandbag Revetment Built Against a Structure.	109
Figure 5.13. Expedient Sandbag Filler.	110
Figure 5.14. Sandbag Revetments – Layout and Construction.	111
Figure 5.15. Sandbags Reinforcing Existing Revetments.	112
5.4. Metal Revetments.	113
Figure 5.16. B-1 Revetment.	113
Figure 5.17. Corrugated Galvanized Steel Revetments.	114
Table 5.2. Specifications and Ordering Information.	114
5.5. Precast Concrete Revetments.	115
Figure 5.18. Precast Concrete Revetment.	115

5.6. Precast Concrete Wall.	116
Figure 5.19. Precast Concrete Wall.	116
5.7. Soil–Cement Revetments.	117
Figure 5.20. Soil–Cement Revetment.	117
5.8. Concrete Culverts.	118
Figure 5.21. Concrete Culvert Soil Bin.	118
5.9. Timber and Lumber Revetments.	119
Figure 5.22. Timber and Lumber Revetments.	119
5.10. Sand Grid Revetments.	120
Figure 5.23. Sand Grid Revetment Construction.	120
5.11. Earth-Filled Container Revetments.	121
Figure 5.24. Earth-Filled Container Revetment – First Layer.	122
Figure 5.25. Coil Hinges and Connecting Pin.	122
Figure 5.26. Earth-Filled Container Revetment – Second Layer.	122
5.12. Siting Revetments.	123
Table 5.3. Principles for Siting Large Structural Revetments.	123
Figure 5.27. Improperly Sited Revetment.	124
Figure 5.28. Properly Sited Revetment.	124
Figure 5.29. Dispersed Pattern for Aircraft Revetments.	125
Figure 5.30. Clustered Patterns for Aircraft Revetments.	126
Figure 5.31. General Examples of Siting Revetments.	127
Attachment 1—GLOSSARY OF REFERENCES AND SUPPORTING INFORMATION.	129
Attachment 2—PROTECTIVE MATERIALS.	139

Attachment 3—FIELD CLASSIFICATION OF SOILS.144

Preface

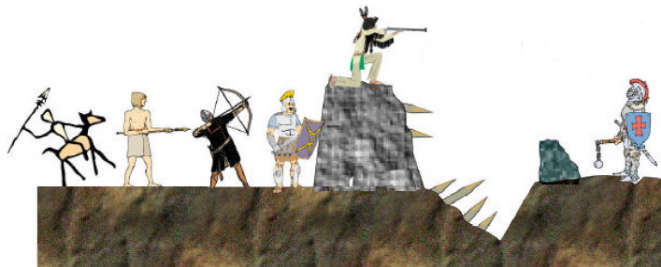
Force protection is a commander's top priority in any military operation. For this reason, civil engineers must always be aware of the latest tactics, techniques, and procedures (TTPs) used to protect our forces, particularly in hostile environments. Engineers implement physical security measures to protect personnel and critical assets needed to achieve military objectives. To assist in these efforts, this handbook is intended to be a reference for constructing and employing expedient fighting positions, obstacles, shelters, and revetments. It focuses primarily upon measures engineers can employ to protect airbases and mitigate the effects of direct- and indirect-fired weapons. This handbook should be used in conjunction with AFH 10-222, Volume 3, *Civil Engineer Guide to Expeditionary Force Protection*, as well as other 10-222 series AF Handbooks and 10-219 series AF Pamphlets. Although many of the TTPs described are designed to protect critical resources through hardening and the use of obstacles, commanders must not lose sight of the fact that standoff provides the best chance of success in protecting the force. In addition to the information contained in the aforementioned publications, civil engineers should be familiar with the security engineering series of Unified Facilities Criteria (UFC) and the latest guidance provided by those organizations constantly testing materials and designs to provide better protection for our military forces. These include organizations such as the Air Force Research Laboratory (AFRL) and the US Army Corps of Engineers (USACE) Protective Design Center (PDC). This handbook does not address TTPs designed to defeat the vehicle-borne improvised explosive device (VBIED) threat. The Air Force Battlelab, through extensive testing, developed an excellent handbook for this purpose. AFH 10-2401, *Vehicle Bomb Mitigation Guide* (FOUO), focuses on the threat of VBIED attacks and describes the latest TTPs that can be employed to defeat this tactic. This handbook does not contain information for designing collective protection shelters. This information can be found in AFMAN 10-2502 series publications and USACE Engineering Technical Letters (ETLs) 1110-3-490 and 1110-3-498. USACE ETLs can be downloaded from <http://www.usace.army.mil/>.

Chapter 1

INTRODUCTION

1.1. Overview. Although tactics, techniques, and procedures (TTPs) used in modern warfare have evolved throughout history, the basic concepts of defense and the use of earthworks remain critical elements of force protection (FP). Historically, earthworks consisted of three parts: a ditch or trench, a short mound of earth material (a parapet) on the enemy side of the ditch to disrupt the enemy's flow, and a higher mound on the defenders' side of the ditch for protection and to cover troop movements (**Figure 1.1**). Earthworks were often reinforced with wood, stone, and rocks and fortified with stakes to provide additional obstacles to slow down the enemy's approach or defend against larger weapons like the catapult and cannon. This concept of defense and other methods of fortification carry over to modern uses of earthworks. The TTPs covered in this handbook relate to the construction and employment of defensive fighting positions, protective shelters, obstacles, and retentments. Although the TTPs are aimed at mitigating the effects of blast and fragmentation effects from conventional weapons, many of these measures can also provide protection against the effects of nuclear weapons. However, refer to AFTTP(I) 3-2.46, *Multiservice Tactics, Techniques, and Procedures for Nuclear, Biological, and Chemical (NBC) Protection*, for guidance on constructing fighting positions and using existing shelters for protection against NBC effects. Before protective measures can be employed effectively in an expeditionary environment, it is necessary to understand the threat.

Figure 1.1. Historic Earthworks.



1.2. The Threat. Direct- and indirect-fired weapons are common threats to airbases. Direct-fired weapons are projectiles designed to penetrate exterior protection. These weapons are highly accurate and capable of firing different types of projectiles including: (1) chemical or kinetic energy projectiles, (2) ball or tracer rounds, and (3) armor piercing rounds or high explosive shaped charges. Indirect-fired weapons include mortars, artillery shells, rockets, and bombs. These types of weapons are highly mobile and easily concealed. They can be fired from launchers or set on timers to allow aggressors time to escape prior to launch. Indirect-fired weapons do not require a clear line of sight to a specific target; aggressors rely on blast and fragmentation effects to damage or destroy their intended targets. **Table 1.1** lists typical weapons and describes their effects. Planners must consider these potential threats.

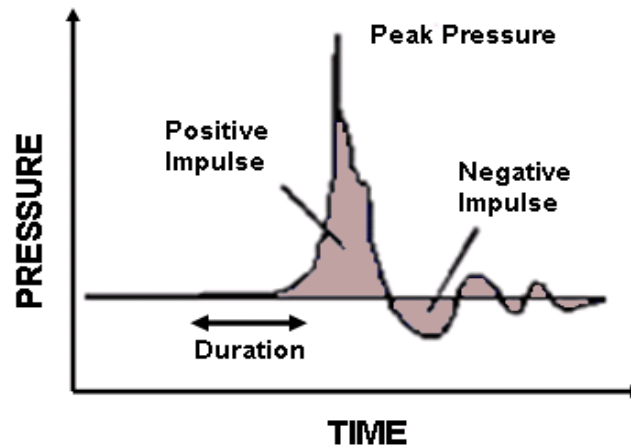
Table 1.1. Typical Weapons and Their Effects.

Weapon	Effects
Projectiles: small arms and aircraft cannons, direct- and indirect-fired projectiles, grenades, etc.	Penetration, spalling, blast, fragmentation.
Bombs: high-explosive (HE), fire and incendiary, dispenser, cluster, etc.	Blast, fragmentation, target penetration, ground shock, cratering, ejecta, extreme heat and fire.
Rockets and Missiles: Tactical and battlefield support weapons, etc.	Target penetration, blast, fragmentation, ground shock, cratering, and ejecta.
Special Purpose Weapons: Fuel-air munitions, incendiary, demolition charges, etc.	Airblast, intense heat, noxious gases, oxygen deprivation, in-structure shock, cratering, ground shock.

1.2.1. Blast and Fragmentation Effects. Exploding munitions produce extreme hazards such as blast and fragmentation. Mitigating the effects of these weapons must be a top priority for civil engineers during contingencies. Bed-down and sustainment efforts might become futile if the force itself is vulnerable to a potentially devastating attack. Blast and fragmentation effects are briefly described in the following paragraphs.

1.2.1.1. **Blast Effects.** Explosive charges release an enormous amount of energy instantaneously through thermal radiation and shock waves. The shock wave is a compression wave that causes the atmospheric pressure to rise (overpressure) and peak in a fraction of a microsecond, followed by a slower (hundredths of a second) decline in atmospheric pressure, referred to as the positive phase of the shock wave. The pressure continues to decline to subatmospheric pressure (negative phase of the shock wave), and then returns to normal (**Figure 1.2**). The positive impulse (intense pressure), represented by the area below the positive phase of the pressure-time curve, causes serious damage and destruction. It is important to know that blasts from high-explosive shells or rockets occur in three distinct ways: (1) overhead burst from artillery, which can destroy structures from the top; (2) contact burst; artillery shells that explode upon impact, causing excavations and other structures to collapse from ground shock or foundation instability; and (3) delay fuze bursts, which are projectiles designed to penetrate a target before detonating. Information on the effects of blasts on all types of structures can be found on the USACE PDC website at <https://pdc.usace.army.mil>.

Figure 1.2. Pressure-Time Curve.



1.2.1.2. **Fragmentation Effects.** Fragmentation effects of weapons are characterized as either primary or secondary fragmentation. Fragmenting weapons are designed to propel debris from their casings (primary fragmentation) towards a target to damage or destroy it. Secondary fragmentation is caused when the force of a blast causes objects to break apart, propelling additional debris towards critical assets at extremely high velocities. The following paragraphs explain these effects in more detail.

1.2.1.2.1. **Primary Fragmentation.** Primary fragmentation is caused by the breakup or shattering of weapon casings upon detonation. The steel casings of fragmenting weapons are designed to produce a mass amount of debris traveling at a high rate of speed (thousands of feet per second) when the projectile detonates and disintegrates. Fragmentation effects caused by detonation of a high-explosive bomb have a greater effective range than blast effects. These types of weapons are very effective against unprotected personnel and other soft targets. The destructive power of fragmenting weapons is maximized by using bombs specifically designed to achieve this effect or by using bombs with airburst functioning fuzes. Although fragmentation effects can be mitigated by well-designed obstructions on the ground, planners must also consider the effect of a direct hit or an airburst.

1.2.1.2.2. **Secondary Fragmentation.** Secondary fragmentation is caused when blast pressure from a weapon detonation exerts enough force upon existing structures in close proximity to cause the structure to break apart and become additional projectiles traveling at high rates of speed. Although it may be impractical to harden temporary structures to resist the effects of blast or fragmentation without sufficient standoff, properly constructed protective structures such as berms and revetments can provide some degree of protection without posing the risk of becoming fragmentation hazards themselves. To be effective, berms and revetments must be properly sited in relation to the assets they are intended to protect. Siting and constructing berms and revetments are covered in more detail in [Chapter 5](#) of this handbook.

1.3. Planning. Civil engineers must develop plans to employ physical security measures designed to mitigate the effects of an enemy attack. This is a unique challenge in the expeditionary environment, since mobility assets are usually not designed to be capable of withstanding attacks from different types of weapons. For this reason, standoff, modern application of earthworks, and other expedient methods are used to counter known threats.

1.3.1. Planning Factors. Some key factors engineers consider while planning for physical security include desired levels of protection, potential threats, criticality and vulnerability assessments, and acceptable levels of risk. In addition, planners must take into account the type of structures to be deployed, available funding, existing infrastructure (including natural and manmade features), available standoff, and local resources available, such as contract support and indigenous construction materials. These factors, and any others unique to the deployed location, form the basis for force protection planning.

1.3.2. Levels of Protection. Physical security measures are employed to obtain certain levels of protection. These protection levels are usually based upon known threats and the results of intelligence and assessment reports. It is unrealistic to believe all assets can be protected and the threat completely eliminated. This perception causes valuable resources to be wasted or misallocated. Risk management is based on the assumption that some risks must be taken to ensure limited resources are applied against the highest priority assets first, rather than all assets equally. Criticality assessments usually result in the assignment of certain values to particular assets. They reveal the degree of debilitating impact that destruction of certain assets would have upon the mission; obviously, personnel come first. Unacceptable losses require higher levels of protection. Assets most critical to the mission must be afforded higher levels of protection, especially if vulnerability assessments indicate these assets are not already sufficiently protected. Different levels of protection are described in UFC 4-020-01, *DOD Security Engineering Facilities Planning Manual*. The following paragraphs cover the assessments usually conducted to assist commanders in determining levels of protection.

1.3.3. **Threat Assessment.** This assessment is used to identify threats based on key factors such as the existence, capability, and intentions of potential hostile forces and terrorist groups. Group activities and the operational environment are also considered. Potential threats are categorized in various ways (e.g., terrorists, saboteurs, spies, extremists, criminals). Any weapons, tools, and explosives likely to be used in an attack upon DOD personnel or critical assets are also identified during the assessment.

1.3.4. **Criticality Assessment.** The criticality assessment is the process used to systematically identify key assets (e.g., personnel, equipment, stockpiles, buildings) deemed mission critical by commanders based on their importance to the mission or function. This assessment forms the basis for prioritizing assets requiring certain levels of protection. Commanders must consider all assets that need protection, all required protective measures, and all available resources (e.g., time, materials, personnel, equipment).

1.3.5. **Vulnerability Assessment.** The vulnerability assessment is an evaluation conducted to determine if key assets are provided appropriate levels of protection. Protection levels are based on minimum standards where no specific threat has been identified or on higher levels of protection where a specific threat has been identified. This assessment analyzes the threat, likely tactics, and key targets that may be vulnerable to attack.

1.3.6. **Risk Assessment.** Risk assessments help commanders make decisions on the most effective ways to allocate limited resources needed to protect personnel and critical assets. The assessment is based upon the results of the threat, criticality, and vulnerability assessments. Based on these assessments, the commander commits resources to achieve certain levels of protection for personnel and mission-critical assets. With limited resources, all assets cannot be afforded equal levels of protection. Risk Management provides the commander with the best information available to make resource allocation decisions. If plans do not incorporate these assessments, they will likely be too reactive and cause limited resources to be misdirected or wasted. For additional information on the assessments used in determining levels of protection, refer to AFH 10-222, Volume 3, *Civil Engineer Guide to Expeditionary Force Protection*.

1.3.7. **Resources.** Planners must identify resources needed to implement security measures throughout all stages of deployments. A limited amount of resources usually drives the need to apply risk management to ensure the most critical assets are adequately protected. The following paragraphs cover the areas planners must consider.

1.3.7.1. **Funding.** Funding for FP resources must be given the highest priority. Although civil engineers may not be directly involved with funding decisions at the highest levels, it is important to know that the Chairman of the Joint Chiefs of Staff has access to a special fund, known as the Combating Terrorism Readiness Initiative Fund (CbTRIF). The CbTRIF is a joint-services fund designed to fund projects for emergent or high-priority force protection equipment or construction. These funds can be used to procure physical security equipment to reduce vulnerabilities. Requests for funding through this process must be for unanticipated requirements where the urgency for funding cannot be met through the normal Service funding process. However funds are obtained, ensure all FP requirements are clearly identified and address the exact purpose for which the requirements are needed, including vulnerabilities that commanders must address (unless classified).

1.3.7.2. **Materials and Equipment.** Class IV materials (i.e., construction and barrier materials) are available through many sources, including the Defense Logistics Agency's Defense Supply Centers at <https://www.dla.mil>. Planners should become familiar with these sources and the different types of construction materials that can be acquired. If construction materials and other equipment resources (e.g., earth-moving and material handling equipment) are not readily available in the deployed area, these items may need to be purchased and brought forward to establish some level of protection during initial beddown. Planners must also be aware that locally available materials and equipment may be of inferior quality, making it difficult to implement effective FP measures. When planning for materials and equipment, consider the possibility of increased threats that may require additional resources. Also, consider the possibility of pre-positioning FP resources at or near the site as war reserve materiel; this will provide the capability to quickly implement physical security measures in conjunction with initial beddown.

1.3.8. Training. Every effort must be made to ensure civil engineers are sufficiently trained on physical security TTPs prior to deploying. Hands-on training is needed to ensure deploying personnel are proficient in constructing critical structures such as guard towers, berms, ditches and protective shelters. There are several training venues available to assist civil engineers prior to expeditionary deployments.

1.3.8.1. US Army Corps of Engineers (USACE) Protective Design Center (PDC). The USACE PDC offers several training courses on security engineering and protective design. These courses are in-resident and range from two to eight days. Some courses cover the different software programs used to estimate blast effects. For example, the Blast Effects Estimation Model (BEEM) is an assessment tool used to estimate facility damage and personnel injuries resulting from an attack. The BlastX software performs calculations of shock wave effects. Keep in mind, engineers using this software must be extremely familiar with the different programs and their application to avoid miscalculating or misinterpreting specific outputs. Mobile Training Teams (MTTs) can also be scheduled to conduct security engineering courses at a unit's home station. However, the unit must pay all expenses related to bringing MTTs to their location. The PDC also has an on-line open forum that allows members to post questions and receive information from engineers who are experts in a variety of areas. For additional information, go to the PDC website at <https://pdc.usace.army.mil>.

1.3.8.2. Theater Construction Management System (TCMS). TCMS is a PC-based automated construction planning, design, management, and reporting system that is used by military engineers for contingency construction activities. Its primary purpose is to support OCONUS (outside the Continental United States) requirements. It combines state-of-the-art computer hardware and software with Army Facilities Component System (AFCS) design information to support and enhance the accomplishment of engineer mission activities in the theater of operation or other mission arenas. A wealth of information, including drawings and specifications for expeditionary structures, such a guard towers, revetments, and various obstacles, can be retrieved through TCMS at <http://www.tcms.net>.

1.4. Protective Construction. Protective construction refers to the design, construction, and layout of facilities to support an integrated and in-depth plan to protect personnel and critical assets from enemy attack. From a civil engineer perspective, these efforts should be focused on activities related to survivability. The mission cannot be successfully accomplished if the force is devastated by enemy attacks. Survivability, defined in JP 3-34, *Engineer Doctrine for Joint Operations*, involves a concept aimed at protecting all aspects of a military operation (e.g., personnel, weapons, supplies) while simultaneously maintaining the capability to deceive the enemy. Survivability tactics include building a strong defense; employing frequent movement tactics; using camouflage, concealment, and deception (CCD); and constructing fighting and protective positions for personnel and equipment (**Figure 1.3**). In addition to guidance provided in this handbook, several publications (classified FOUO) provide detailed guidance to ensure appropriate levels of protection are provided for key assets based on specific locations and threats. These documents, sometimes referred to as the security engineering series of UFCs, are listed in **Table 1.2**. In addition to UFCs, planners should be familiar with the latest TTPs outlined in the Joint Contingency Operations Base (JCOB) Force Protection Handbook and the Joint Forward Operations Base (JFOB) Force Protection Handbook. These documents can be downloaded from the Joint Staff Antiterrorism Portal (ATEP) website at <https://atep.dtic.mil>.

Figure 1.3. Protective Shelter Construction.



Table 1.2. Security Engineering Series of Unified Facilities Criteria.

Publication #	Publication Title
UFC 4-010-01	DOD Minimum Antiterrorism Standards for Buildings
UFC 4-010-02	DOD Minimum Antiterrorism Standoff Distances for Buildings
UFC 4-020-01FA	DOD Security Engineering Facilities Planning Manual
UFC 4-020-02FA	DOD Security Engineering Facilities Design Manual
UFC 4-020-03FA	Security Engineering: Final Design
UFC 4-021-01	Design and O&M: Mass Notification Systems
UFC 4-021-02	Security Engineering: Electronic Security Systems
UFC 4-022-01	Entry Control Facilities/Access Control Points
UFC 4-022-02	Design and Selection of Vehicle Barriers
UFC 4-022-03/ MIL-HDBK-1013/10	Design of Security Fencing, Gates, Barriers, and Guard Facilities
UFC 4-023-03	Design of Buildings to Resist Progressive Collapse
UFC 4-023-04	Design of Windows to Resist Blast, Ballistics, and Forced Entry
UFC 4-023-07	Design to Resist Direct Fire Weapons Effects
UFC 4-026-01	Design to Resist Forced Entry
UFC 4-027-01	Design of Deployed Operational Bases to Mitigate Terrorist Attacks



Chapter 2

FIGHTING POSITIONS

2.1. Overview. Fighting positions are fortified structures used for protection against hostile fire. They can also be used as central points from which to direct fire at offensive forces and provide overlapping fields of fire with adjacent fighting positions. The positions are constructed either hastily or deliberately, depending on the availability of time, materials, and the threat. Ideally, they should be sited to take advantage of natural terrain that conceals them and obscures direct lines of sight while providing a means to direct fire towards the enemy. Overhead cover is constructed when time is not a factor. The most important point to remember when constructing a fighting position is to make sure it cannot be detected. Do not site these positions where the enemy expects to find them. Once detected, the “element of surprise” will be lost. Camouflage should be applied to these positions to further complicate the enemy’s ability to detect them. All of these tactics provide security forces with the capability needed to decisively eliminate attempts to penetrate camp boundaries or launch attacks upon military installations.

2.2. Safety. Safety is paramount to constructing fighting positions. Personnel have been killed and injured as a result of improperly constructed fighting positions. FM 5-34, *Engineer Field Data*, FM 5-103, *Survivability*, and Government Training Aid (GTA) 05-08-001, *Survivability Positions*, contain guidance for proper construction. Supervisors must ensure their personnel are trained on these procedures and should always supervise the actual construction. Once constructed, these positions must be inspected frequently, especially after the area experiences heavy rainfall and immediately after an attack. [Table 2.1](#) contains basic criteria for constructing fighting positions.

2.3. Materials. During contingencies, engineers use whatever materials are available to construct and fortify fighting positions. [Attachment 2](#) lists protective characteristics of some materials that can be used for these efforts along with information that can be used to determine the required thickness of materials needed to mitigate the effects of various types of weapons.

Table 2.1. Checklist - Basic Criteria for Fighting Positions.

1	<input type="checkbox"/>	Construct fighting positions IAW FM 5-34 and GTA 05-08-001
2	<input type="checkbox"/>	Use proper material; always follow proper construction procedures
3	<input type="checkbox"/>	Make sure positions provide protection from direct enemy fire
4	<input type="checkbox"/>	Position enables personnel to engage enemy with assigned sectors
5	<input type="checkbox"/>	Do not site positions where the enemy expects to find them
6	<input type="checkbox"/>	Site positions where they are concealed by natural barriers
7	<input type="checkbox"/>	Site positions to provide for effective interlocking fires
8	<input type="checkbox"/>	Camouflage positions to blend with the surrounding terrain
9	<input type="checkbox"/>	Ensure positions are not be detectable from 35 meters (40 yards)
10	<input type="checkbox"/>	Ensure occupants are not silhouetted against the surroundings
11	<input type="checkbox"/>	Construct parapets at least 39 inches thick (length of an M-16 rifle)
12	<input type="checkbox"/>	Construct parapets at least 12 inches high (length of a bayonet)
13	<input type="checkbox"/>	Build front/flank/rear parapets one-helmet distance from the hole
14	<input type="checkbox"/>	Revet excavations in areas with sandy soil to prevent collapse
15	<input type="checkbox"/>	Use structural support for stringers; do not use sandbags for support
16	<input type="checkbox"/>	Dig in structural supports approximately ½ their height/diameter
17	<input type="checkbox"/>	Ensure stringers are spaced using guidance in GTA 05-08-001
18	<input type="checkbox"/>	Check stabilization of wall bases and make needed adjustments
19	<input type="checkbox"/>	Do not drive vehicles within 6 feet of positions in sandy soil
20	<input type="checkbox"/>	Construct deliberate fighting positions approximately armpit deep
21	<input type="checkbox"/>	Construct hasty fighting positions at least 18 inches deep
22	<input type="checkbox"/>	Fill sandbags approximately 75 percent and tighten choke cords
23	<input type="checkbox"/>	Provide at least 18 inches of cover to protect against indirect fire
24	<input type="checkbox"/>	Provide additional cover as needed based on the threat
25	<input type="checkbox"/>	Supervise construction and inspect fighting positions daily
26	<input type="checkbox"/>	Maintain, repair, and improve fighting positions as time permits

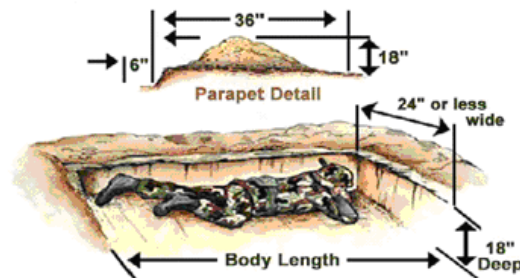
2.4. Hasty Fighting Positions. Hasty fighting positions are used when time and materials are limited. They can be constructed using whatever objects or materials that inhabit the area (i.e., dirt, trees, logs, boulders, etc.). If an existing depression is available, it can be used as a hasty fighting position. Hasty fighting positions are constructed by digging a hole at least 18 inches deep for protection against indirect fire. The position should be able to accommodate the occupant, be at least 24 inches wide, and include parapets for frontal and flank cover. Ideally, the position is sited where natural cover from direct fire is available (i.e., trees, large rocks, rubble, etc.). This helps to conceal the position and make enemy detection difficult. If natural cover is not available, use the soil excavated from the hole or other fill material in the surrounding area to construct parapets. **NOTE:** Do not leave fresh soil exposed – the entire position must be camouflaged. Parapets should be at least 18 inches high, 36 inches thick, and 6 inches (one-helmet distance) away from the hole. If logs are used instead of soil or sandbags, they must be held firmly in place with strong stakes 2 to 3 inches in diameter and approximately 18 inches long. Frontal cover is constructed for protection against small caliber direct fire. Flank and rear cover is used to mitigate the effects of indirect fire burst to the flank and rear. Hasty fighting positions can be set up quickly with little effort, but provide a minimum amount of protection. If properly located, and the unit will remain in the area, improve the position as time permits to include overhead cover. Use the basic criteria presented earlier in [Table 2.1](#) and FM 5-103 when constructing hasty fighting positions. The following paragraphs contain brief descriptions of various hasty fighting positions.

2.4.1. Crater Positions. Crater positions, which are depressions in the ground caused by exploding shells or bombs, can provide protection under direct fire. These positions should be at least 2 to 3 feet wide and 18 inches deep. The trenching tool is used to dig a steep face or parapet for added protection.

2.4.2. Skirmisher's Trench. A skirmisher's trench can also provide immediate cover. This position requires troops to lie down in the prone position and use the entrenching tool or other means to scrape the surrounding soil and build parapets between themselves and the direction of enemy fire.

2.4.3. **Prone Position.** The prone position, illustrated in [Figure 2.1](#), is an improved skirmisher's trench that conforms to the position and body length of its occupant. It serves as a good firing position and provides better protection from direct fire weapons than the crater or skirmisher's trench. Parapets, 18 inches in height, should be constructed around the position for protection against indirect fire. However, because this is essentially a hasty position, overhead cover is not usually constructed.

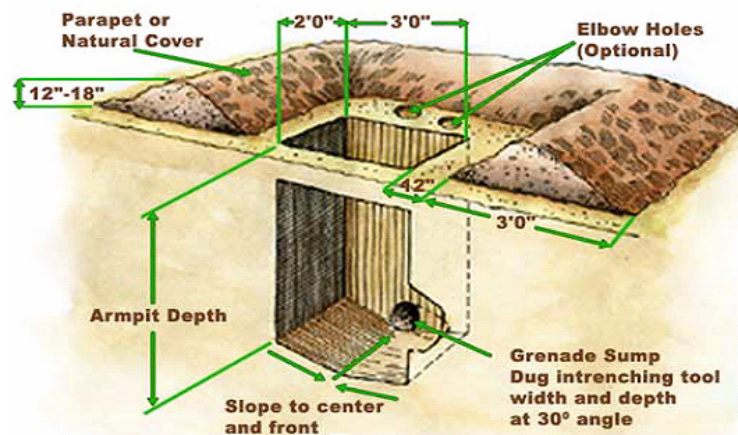
Figure 2.1. Hasty Fighting Position.



2.5. Deliberate Fighting Positions. Deliberate fighting positions are designed to accommodate personnel, their equipment, and certain weapons to be employed from the position. These positions are more protective and should be constructed if a unit will be in a particular location for an extended time. Several types of deliberate fighting positions can be constructed based on (1) the weapon to be employed from the position, (2) the number of personnel that will occupy the position, and (3) the amount of gear and equipment the position must accommodate. Supervisors ensure positions are properly constructed and overlapping fields of fire are provided with adjacent fighting positions. The next few paragraphs describe procedures for constructing deliberate fighting positions. Although some guidance is provided here, refer to FM 5-103 for details on constructing intercepting trenches for fighting positions sited in areas that may experience ground shock.

2.5.1. One-Person Deliberate Fighting Position. One-person deliberate fighting positions ([Figure 2.2](#)) are constructed when time and materials are available and the tactical situation warrants additional protection. The excavation is relatively small, making it easier to use materials from the surrounding area for overhead cover and camouflage. This position must allow the individual to fire to the front and oblique while behind frontal cover. All of the basic construction criteria established for one-person deliberate fighting positions also applies to fighting positions constructed on larger scales and for different reasons. Critical aspects of constructing a one-person deliberate fighting position will be covered first; variations to these basics will follow.

Figure 2.2. One-Person Deliberate Fighting Position.



2.5.1.1. Sectors of Fire. Sectors of fire are usually assigned by security personnel and form the basis for siting positions. If possible, select an area that will provide natural frontal cover protection from enemy direct fire. If natural cover is unavailable where the position is sited, construct parapets.

2.5.1.2. **Aiming and Sector Stakes.** Aiming and sector stakes can be employed to help security personnel with firing and to define sectors of fire. Outline the position as shown in **Figure 2.3**. For a one-person position, the hole is usually about the length of an M-16 (roughly 3 feet and 3 inches long) and as wide as two helmets (roughly 2 feet). **NOTE:** This usually is not done for hasty fighting positions.

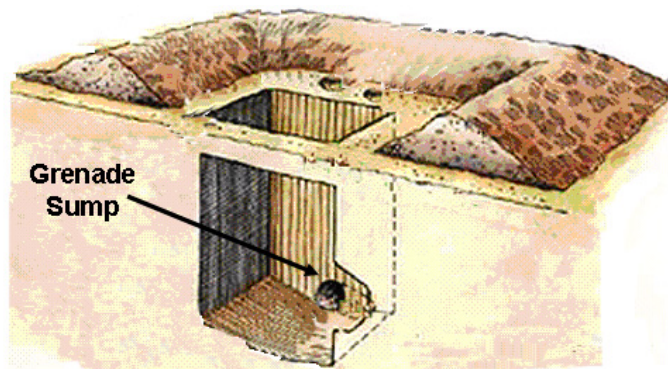
2.5.1.3. **Parapets.** Prepare parapet retaining walls using logs or other natural materials. If logs are used, stake them down firmly with stakes about 2 to 3 inches in diameter and 18 inches long. The walls should be at least 6 inches (one-helmet distance) from the edge of the hole. Build the front wall first, at least two sandbags high (approximately 18 inches), 36 inches thick, and the length of two M-16s (approximately 6 feet and 6 inches long). Sandbags should be 75 percent full. Next, build flank walls with the same height and thickness as that of the front wall, with the length being approximately equal to that of one M-16. The rear wall should be one sandbag high and one M-16 long. Dig the hole to armpit depth and slope the walls. Throw the excavated soil forward of the parapet retaining walls and pack it down hard.

Figure 2.3. Outlining One-Person Fighting Position.



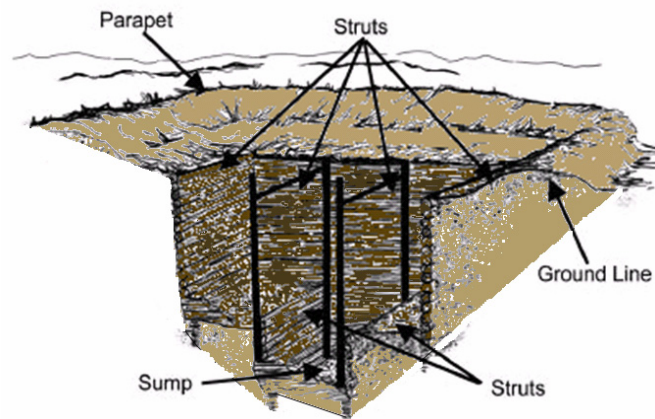
2.5.1.4. Grenade Sumps. Determining where to locate grenade sumps depends on the type of fighting position being constructed. For a one-person fighting position, grenade sumps (**Figure 2.4**) should be dug into the bottom front face of the position at approximately a 30-degree angle and 12 to 18 inches deep, about the length of an entrenching tool. The width of the sump should be approximately equal to the width of the entrenching tool shovel. Use whatever tools are available to slope the floor towards the grenade sump. This will make it easier to kick a grenade into the hole and get out of the way so the blast goes into the back wall. For a larger, two-person fighting position, grenade sumps are usually dug at each end of the position to allow occupants to move towards the opposite end away from the blast. Avoid locating grenade sumps under overhead cover, especially if the cover is constructed across the middle of the fighting position. The blast could reflect off the cover and cause injuries or collapse the entire structure. A combination of grenade sump trenches and holes can be used for special-purpose fighting positions. A T-shaped position allows for additional observation or firing zones but may require additional grenade sumps. Make sure the blast from the sump is not directed towards any occupied sections of the position.

Figure 2.4. Grenade Sump – One-Person Fighting Position.



2.5.1.5. Fighting Position Revetments. In wet, sandy, or poorly compacted soils, revetments are used to reinforce the sides of fighting positions and trenches to prevent collapse (**Figure 2.5**). Revetting is also necessary when positions are dug in soils with large amounts of clay or high plasticity as these soils may liquefy, displace, or shear from ground shock. Without revetments, the walls of a position in sandy soils would have to be sloped to achieve a certain depth. However, this is not recommended since the top opening of the position would be too wide, making it difficult to incorporate overhead cover. Revet fighting positions using material held in place with either braced or tied pickets. Pickets can be lumber, wooden poles, standard concertina wire pickets, metal poles, angular posts, or trees. Wooden pickets from trees or saplings should be at least 3 inches in diameter. The pickets are used to hold matting material (i.e., brushwood mats, lumber, wire mesh, geotextile fabric, cloth mat, etc.) against the soil face. More rigid facing materials include plywood, landing mats, corrugated metal, and timbers. Use the field expedient procedures outlined in **Attachment 3** to classify soils and determine whether revetments are needed.

Figure 2.5. Fighting Position Revetment.



2.5.1.6. Crawl Trenches. If time is available and the overall defensive posture needs to be enhanced, crawl trenches can be constructed to connect fighting positions and prevent personnel from being exposed to enemy fire as they move about the area. The depth of these trenches is based on the availability of time and resources. Engineers will have to assist others with excavation and trench reinforcement (**Figure 2.6**). Crawl trenches should be dug in a zigzagged pattern to prevent the enemy from being able to fire down a long section if the trench is breached. This pattern will also help to reduce the effects of fragmentation if the crawl trench is hit with explosive munitions.

2.5.1.7. Ground Shock Intercept Trenches. Since fighting positions might be needed in areas subject to high levels of ground shock based on certain soil or geological conditions, civil engineers must have some general knowledge of geology and different soil types. Ground shock sufficient enough to collapse fighting positions can occur when these positions are constructed over water tables too close to the bottom of the positions or in areas where the soil is located within 25 feet of and/or over an underlying rock formation, moist clay, or soils with high water content. Ground shock is intensified by reduced resistance through the soil or reflection from the underlying soil and rock formations. One way to reduce the effect of ground shock on fighting positions involves constructing ground shock intercept trenches. Ground shock intercept trenches are meant to collapse from ground shock and thereby absorb enough of the ground shock to prevent fighting positions from collapsing. These types of trenches are dug approximately 12 inches wide to a depth that is at least 2 feet deeper than the fighting positions they are intended to protect. They should also be at least 6 feet longer than the width of the fighting position. Locate the trenches away from fighting positions at a distance approximately 1 1/2 to 2 times the depth of the trench, as illustrated in **Figure 2.7**. Due to their narrow width, these trenches can easily be camouflaged. **Table 2.2** can be used as a checklist to ensure revetments, crawl trenches, and ground shock intercept trenches are being properly constructed.

Figure 2.6. Reinforced Trenches.

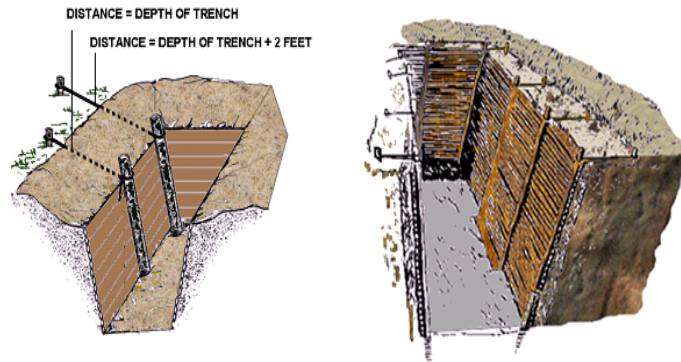


Figure 2.7. Ground Shock Intercept Trenches.

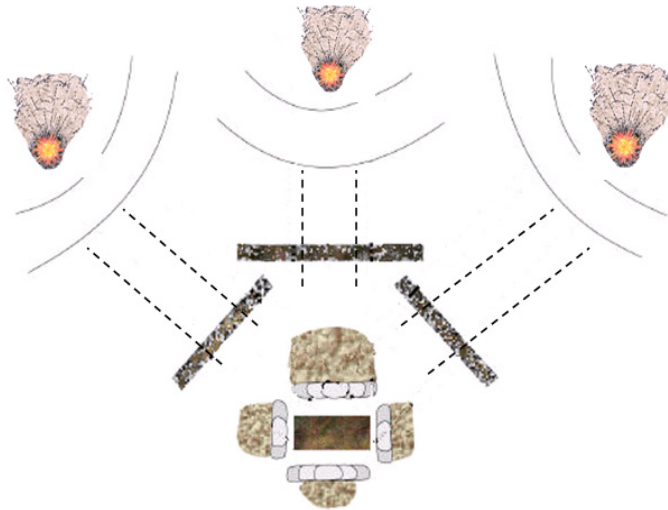


Table 2.2. Checklist - Fighting Position Revetments and Trenches.

1 <input type="checkbox"/>	Use field soil sampling techniques (Attachment 3) to determine soil types and whether revetments will be required
2 <input type="checkbox"/>	Use lumber, wooden poles, metal poles, concertina wire pickets, or trees as pickets to hold revetting material in place
3 <input type="checkbox"/>	If wooden pickets from trees or saplings are used for pickets, ensure they are at least 3 inches in diameter
4 <input type="checkbox"/>	Use flexible items such as brushwood mats, wire mesh, geotextile fabric, and cloth mats for facing material if available
5 <input type="checkbox"/>	Use more rigid items such as corrugated metal sheets, landing mats, and lumber for facing material if available
6 <input type="checkbox"/>	Space pickets based on soil type and facing material used (up to 30 inches for flexible material and 78 inches for rigid material)
7 <input type="checkbox"/>	Drive pickets at least 18 inches into the ground; use stakes to help stabilize the pickets in place if needed
8 <input type="checkbox"/>	Drive stakes into the ground at a distance from the edge of the excavation equal to the depth of the excavation
9 <input type="checkbox"/>	If more than 3 or 4 stakes are used, alternate the distance; place every other stake equal to the depth of the excavation plus 2 feet
10 <input type="checkbox"/>	Consider the need to construct ground shock intercept trenches to absorb ground shock from explosions near fighting positions
11 <input type="checkbox"/>	If needed, construct ground shock intercept trenches between fighting positions and likely impact point for high explosives
12 <input type="checkbox"/>	Dig intercept trenches at least 12 feet wide and at least 2 feet deeper than fighting positions
13 <input type="checkbox"/>	Dig intercept trenches at least 6 feet longer than the width of the fighting positions they are meant to protect
14 <input type="checkbox"/>	Locate intercept trenches away from fighting positions at a horizontal distance of 1 1/2 to 2 times the depth of the trench

2.5.1.8. Fighting Position Overhead Protection and Cover. Fighting position overhead protection is used to mitigate the effects of blast and fragmentation from direct- and indirect-fired weapons. Cover provides concealment and protects against weather. Overhead protection and cover are always needed unless it will make the position easy to detect. The following paragraphs cover basic concepts for overhead protection and cover. **Attachment 2** contains information on thicknesses for protection against certain weapons. However, always reference FM 5-103, GTA 05-08-001, and GTA 07-06-001, *Fighting Position Construction Infantry Leader's Reference Card*.

2.5.1.8.1. Roof Supports. For standard one- and two-person fighting positions, 4-inch x 4-inch x 6-foot lumber or timber equivalents are normally used for roof supports. To form the base structure for overhead cover, logs or lumber 4 to 6 inches in diameter can be used. **Table 2.3** compares cut timber to the equivalent size of processed lumber. If logs are used, secure them with stakes approximately 2 to 3 inches in diameter and about 18 inches long. Make sure bearing support beams are properly positioned. Set support logs back a distance equal to approximately 1/4 the depth of the hole and embedded approximately halfway into the ground as illustrated in **Figure 2.8**. Set overhead cover supports back about 1 foot or 1/4 the depth of the hole.

2.5.1.8.2. Stringers. Stringers are made from solid and sturdy material, such as lumber or timber, and are used to support overhead cover. For standard one- and two-person fighting positions, 4-inch x 4-inch x 8-foot lumber or timber equivalents are normally used and spaced 6 inches on-center. On-center spacing is critical to the safety of fighting positions. If stringers are placed too far apart, they will be less capable of carrying the dead weight of overhead cover. Stringer span (the unsupported distance between each end of material used as stringers) is also critical. **Table 2.4**, extracted from GTA 05-08-001, can be used to determine span and center-to-center spacing for wood-supporting soil cover to defeat various contact bursts. **Figure 2.9** illustrates stringer placement for overhead cover. Ensure stringers are approximately the same size as roof supports, are laid side by side across them, extending at least 1-foot past the supports on each side of the fighting position.

Table 2.3. Timber and Processed Lumber Comparison.

Cut Timber/Log Diameter (inches)	Equivalent Size of Processed Lumber (inches)
5	4 x 4
7	6 x 6
8	6 x 8
10	8 x 8
11	8 x 10
12	10 x 10
13	10 x 12
14	12 x 12

Figure 2.8. Placement of Roof Support Logs.

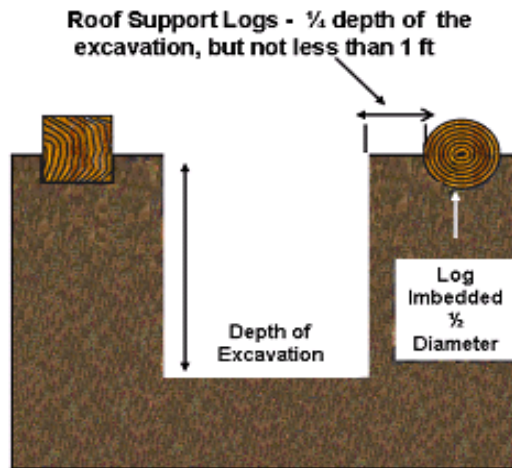
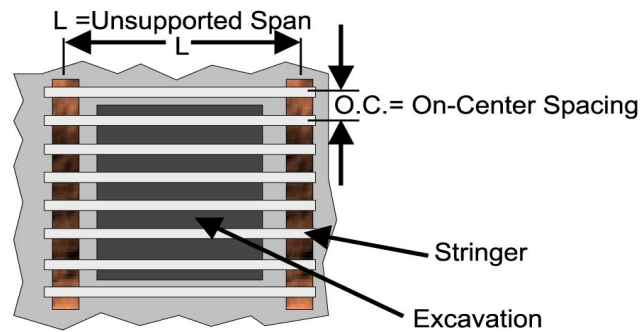


Table 2.4. Center-to-Center Spacing for Wood Stringers and Soil Cover to Defeat Contact Bursts.

Nominal Stringer Size (inches)	Depth of Soil, feet (meters)	Span Length, feet (meters)				
		2 (0.6)	4 (1.2)	6 (1.8)	8 (2.4)	10 (3.0)
		Center to Center Stringer Spacing, inches (centimeters)				
82-mm Contact Burst						
2x4	2 (0.6)	3 (7.6)	4 (10)	4 (10)	4 (10)	3 (8)
	3 (0.9)	18 (46)	12 (30)	8 (20)	5 (13)	3 (8)
	4 (1.2)	18 (46)	14 (36)	7 (18)	4 (10)	3 (8)
2x6	2 (0.6)	4 (10)	7 (18)	8 (20)	8 (20)	6 (15)
	3 (0.9)	18 (46)	18 (46)	16 (41)	12 (30)	8 (20)
	4 (1.2)	18 (46)	18 (46)	18 (46)	11 (28)	7 (18)
4x4	2 (0.6)	7 (18)	10 (25)	10 (25)	9 (22)	7 (18)
	3 (0.9)	18 (46)	18 (46)	18 (46)	12 (30)	8 (20)
	4 (1.2)	18 (46)	18 (46)	18 (46)	10 (25)	7 (18)
4x8	1.5 (0.5)	4 (10)	5 (13)	7 (18)	8 (20)	8 (20)
	2 (0.6)	14 (36)	18 (46)	18 (46)	18 (46)	18 (46)
	3 (0.9)	18 (46)	18 (46)	18 (46)	18 (46)	18 (46)
120- and 122-mm Contact Burst						
4x8	4.0 (1.2)	3.5 (9)	4 (10)	5 (13)	5 (13)	6 (15)
	5.0 (1.5)	12 (30)	12 (30)	12 (30)	11 (28)	10 (25)
	6.0 (1.8)	18 (46)	18 (46)	18 (46)	16 (41)	12 (30)
6x6	4.0 (1.2)	--	--	5.5 (14)	6 (15)	6 (15)
	5.0 (1.5)	14 (36)	14 (36)	13 (33)	12 (30)	10 (25)
	6.0 (1.8)	18 (46)	18 (46)	18 (46)	16 (41)	12 (30)
6x8	4.0 (1.2)	5.5 (14)	6 (15)	8 (20)	9 (23)	10 (25)
	5.0 (1.5)	18 (46)	18 (46)	18 (46)	18 (46)	18 (46)
8x8	4.0 (1.2)	7.5 (19)	9 (23)	11 (28)	12 (30)	13 (33)
	5.0 (1.5)	18 (46)	18 (46)	18 (46)	18 (46)	18 (46)
152-mm Contact Burst						
4x8	4.0 (1.2)	--	--	--	--	3.5 (9)
	5.0 (1.5)	6 (15)	6 (15)	7 (18)	7 (18)	7 (18)
	6.0 (1.8)	17 (43)	16 (41)	14 (36)	12 (30)	10 (25)
	7.0 (2.1)	18 (46)	18 (46)	18 (46)	15 (38)	11 (28)
6x6	5.0 (1.5)	7 (18)	8 (20)	8 (20)	8 (20)	7 (18)
	6.0 (1.8)	18 (46)	18 (46)	15 (38)	12 (30)	10 (25)
	7.0 (2.1)	18 (46)	18 (46)	18 (46)	15 (38)	11 (28)
6x8	4.0 (1.2)	--	--	--	--	6 (15)
	5.0 (1.5)	10 (25)	11 (28)	12 (30)	12 (30)	12 (30)
	6.0 (1.8)	18 (46)	18 (46)	18 (46)	18 (46)	17 (43)
8x8	4.0 (1.2)	--	--	--	--	8 (20)
	5.0 (1.5)	14 (36)	14 (36)	16 (41)	17 (43)	16 (41)
	6.0 (1.8)	18 (46)	18 (46)	18 (46)	18 (46)	18 (46)

Figure 2.9. Illustration of Unsupported Span and On-Center Spacing.



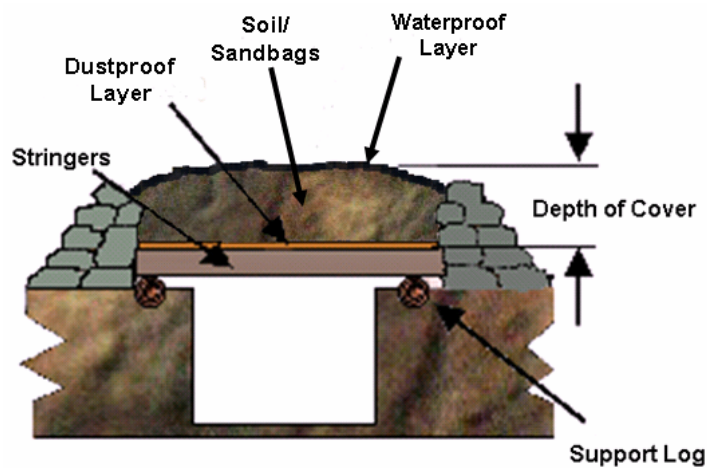
2.5.1.8.3. Dustproof Layer. Once the stringers are properly placed, put a dustproof layer over the base logs/stringers (**Figure 2.10**). The dustproof layer could be 4-foot by 4-foot sheets of 3/4-inch plywood. Nail the plywood dustproof layer to the stringers. This layer will also help to keep water from leaking through the overhead cover into the fighting position.

Figure 2.10. Dustproof Layer.



2.5.1.8.4. **Cover.** Place 6 to 8 inches of soil on top of the dustproof layer (Figure 2.11). If sandbags are used, cover them with waterproof material as well. If they are drenched during rainy weather, sandbags will become very heavy and could cause roof supports to collapse.

Figure 2.11. Completed Fighting Position – Side View.



2.5.1.8.5. **Inspection.** Supervisors should have hands-on experience in constructing various types of fighting positions. There is no substitute for learning by doing. These leaders must be capable of inspecting fighting positions during construction, after they are covered, before they are camouflaged, and again after they are camouflaged to ensure proper procedures are followed. The structure's integrity must be approved before adding overhead cover and applying camouflage. In addition to GTA 05-08-001 and FM 5-103, Table 2.5 can be used to ensure fighting positions are properly constructed.

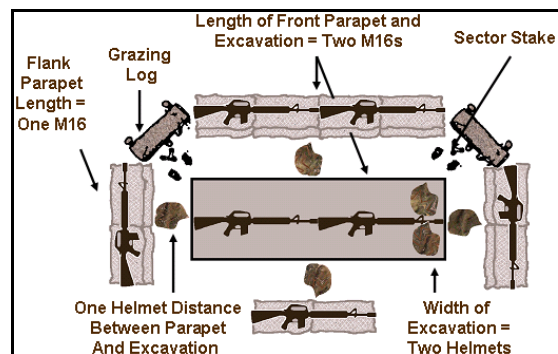
Table 2.5. Checklist – Fighting Position Overhead Cover.

1 <input type="checkbox"/>	Ensure GTA 05-08-001/07-06-001 are available for reference
2 <input type="checkbox"/>	Construct fighting position overhead cover (4 feet in width)
3 <input type="checkbox"/>	Use logs or lumber 4 to 6 inches in diameter for roof support
4 <input type="checkbox"/>	Place roof supports 1/4 depth of the hole from edge of the hole
5 <input type="checkbox"/>	Embed roof support logs/lumber 1/2 diameter into the soil
6 <input type="checkbox"/>	If logs or cut timber are used for roof supports, use stakes 2 to 3 inches in diameter and 18 inches long to secure roof support
7 <input type="checkbox"/>	Build front, flank, and rear parapets two sandbag layers high and 18 inches thick
8 <input type="checkbox"/>	Place stringers (4 to 6 inches in diameter) on top of roof support. Refer to Table 2.6 for stringer spacing
9 <input type="checkbox"/>	Ensure stringers extend past roof supports and into parapets (remove a portion of the parapets and place on top of stringers)
10 <input type="checkbox"/>	Place waterproof bags, ponchos, etc., on top of the stringers
11 <input type="checkbox"/>	Place 6 to 8 inches of packed dirt or sandbags on top of the waterproof material
12 <input type="checkbox"/>	If sandbags are used, place a water-resistant material over the sandbags to prevent them from becoming saturated
13 <input type="checkbox"/>	Cover the dirt with sod, and camouflage the overhead cover
14 <input type="checkbox"/>	Ensure the supervisor inspects the position upon completion and again daily, especially following bad weather or an attack

2.5.1.9. Concealment and Camouflage. The most important consideration in constructing fighting positions is making sure they cannot be detected. After overhead cover is constructed, use concealment and camouflage techniques to make the position undetectable. Concealment is anything that hides the fighting position from enemy observation. It may be natural material (i.e., bushes, leaves, grass, etc.) or artificial material (i.e., burlap, nets, etc.). If possible, locate fighting positions where natural cover, such as bushes, tall grass, trees, logs, stumps, mountainous terrain, or large rocks can help to conceal them. Take advantage of natural cover (i.e., wooded areas, hills, rock formations) for concealment, and cover shiny objects such as watches, compasses, and bayonets. Camouflage is used to blend the position with the surrounding terrain. The key to camouflaging fighting positions is to alter the appearance of the asset being protected in a manner where it becomes part of the background. Camouflage also makes use of natural and manmade material. Study the terrain and vegetation of the area. Natural cover could include materials such as trees, brush, grass, leaves, rocks, or boulders. When using natural cover for concealment, be careful not to disturb the look of the natural surroundings – use materials commonly found in the area where an asset is to be concealed. If vegetation/foilage is used to camouflage a position, it must be replaced before it dries and turns colors, making the position stand out in its surroundings. Since fresh soil can be used to detect a fighting position, it must be disposed of far away from the position. Be careful not to leave tracks leading to or from the position. Do not use too much material; this could make the position stand out from its surroundings. Once the position is completed, inspect it from the enemy's viewpoint. As a final test of camouflage and concealment efforts, mark off 35 meters (38 yards) in the direction of the enemy and look back at the position to determine if it is undetectable and blends in with the surrounding area.

2.5.2. Two-Person Deliberate Fighting Position. Two-person deliberate fighting positions are most common. Basic requirements for these positions are essentially the same as those for one-person fighting positions with key differences. Although this position is preferred, it is not without drawbacks. Two-person fighting positions require more digging and prove difficult to camouflage. It also provides a better target for grenades because the excavation is larger. Typical combat gear such as the M-16 rifle and helmet can be used to measure dimensions (**Figure 2.12**). For example, the length of a two-person fighting position can be measured using two M-16 rifles (approximately 6 feet and 6 inches). The width can be measured with two helmets (approximately 2 feet). The following paragraphs describe details for constructing two-person fighting positions.

Figure 2.12. Two-Person Deliberate Fighting Position.



2.5.2.1. Sectors of Fire. Unlike the one-person deliberate fighting position, the two-person fighting position involves two fields of fire. Fighters occupy opposite ends of the position after being assigned specific sectors of fire. This is referred to as clearing primary and secondary fields of fire.

2.5.2.2. Aiming and Sector Stakes. Place sector stakes and aiming stakes (if needed) at both ends of the fighting position to help stabilize the weapon during firing and assist in targeting when visibility is limited. Position grazing logs or sandbags between the sector stakes for each field of fire.

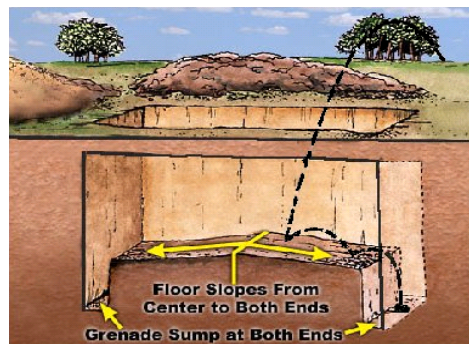
2.5.2.3. **Parapets.** Construct parapets approximately one-helmet distance from the edge of the excavation. Start with the front parapet, and then construct the flank and rear parapets.

2.5.2.4. **Outlining the Fighting Position.** Outline the position on the ground using a tree limb or anything available. A two-person deliberate fighting position is usually rectangular in shape. The length of the deliberate two-person fighting position is approximately two M-16s long. The width is about the length of two helmets. Scoop out elbow holes to help stabilize the weapon when firing.

2.5.2.5. **Digging.** Dig the position armpit deep, throwing the dirt forward to the front parapet, then towards the flank and rear parapets. Pack the dirt down hard. Remove any fresh dirt away from the position so it does not indicate recent excavation activity.

2.5.2.6. **Grenade Sumps.** Grenade sumps are constructed at each end of the two-person deliberate fighting position ([Figure 2.13](#)). This allows the blast to go straight up while occupants move to the opposite end of the position. The floor should be sloped towards the grenade sumps on each end to make it easier to kick the grenade into the sump.

Figure 2.13. Grenade Sumps – Two-Person Deliberate Fighting Position.



2.5.2.7. Additional Considerations. Conduct field soil sampling and determine if revetments or some type of reinforcement is needed. Procedures for conducting soil sampling in the field can be found in [Attachment 3](#). Also, determine if trenches must be constructed to provide additional cover from direct fire. To construct trenches and revetments, follow the same procedures described for one-person deliberate fighting positions.

2.5.2.8. Overhead Cover. Employ the same techniques used to construct overhead cover for the one-person fighting position. Avoid digging grenade sumps under overhead cover, especially if overhead cover is constructed across the middle of the structure. The blast could not only reflect off the cover, but it could also collapse the structure.

2.5.2.9. Camouflage and Concealment. Employ the same camouflage and concealment techniques as those for one-person deliberate fighting positions.

2.5.2.10. Modified Two-Person Deliberate Fighting Position. When fighting positions are designated to provide cover for adjacent fighting positions or to cover dead space in close terrain, rectangular-shaped fighting positions can be modified to provide a wider sector of fire by extending one or both ends of the fighting position at an angle of about 45 degrees. [Figure 2.14](#) and [Figure 2.15](#) illustrate how two-person deliberate fighting positions can be constructed with a rectangular shape for typical sectors of fire and modified (curved) to provide a larger area of coverage. Curving the hole around the frontal cover may be necessary in close terrain for better observation and firing to the front and to the next flank position. A curved fighting position allows one person to maintain watch to the front while the other person rests or eats. It also enables occupants to observe and fire to the front when not being fired at, and to move back behind the frontal cover under heavy fire.

Figure 2.14. Typical Sectors of Fire.

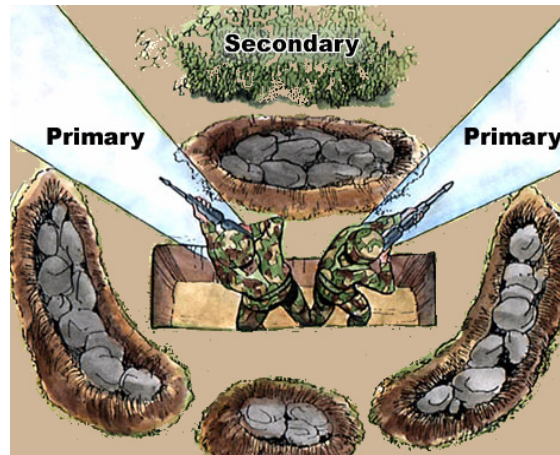
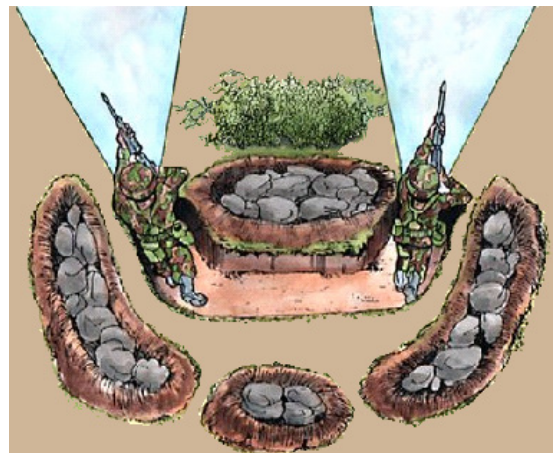


Figure 2.15. Curved Two-Person Deliberate Fighting Position.



2.5.3. Machine Gun Fighting Position. The machine gun fighting position is basically a two-person fighting position with some differences. It is outlined as a T-shaped fighting position with two firing platforms to cover primary and secondary sectors of fire (**Figure 2.16**). Due to the gun's vibrations, sandbags may be needed to line the floor of the platform and stabilize the tripod legs to prevent them from moving. Also, the walls of the platform may need to be reveted. Excavate to armpit depth and use the soil to build frontal, flank, and rear parapets. Dig two grenade sumps and build overhead cover similar to that of a two-person fighting position. For this type of position, the ammunition bearer can dig a one-person fighting position to the flank of the gun position, essentially modifying the position into a three-person fighting position. The ammunition bearer should be able to see and fire to the front and oblique and also to cover the front of the machine gun. The ammunition bearer's position is connected to the machine gun position by a crawl trench that allows the ammunition bearer to bring ammunition to the gun or replace the gunner or assistant gunner (see **Figure 2.17** and **Figure 2.18**). A three-person machine gun fighting position has several advantages; (1) there is a leader in each position, enabling more effective command and control, (2) this type of position allows for 360-degree observation and fields of fire, and (3) with three occupants, one person can provide security; one can do priority work; and one can rest, eat, or perform needed maintenance. Also, this type of position is more difficult to suppress since it is occupied by three fighters.

Figure 2.16. Basic Machine Gun Fighting Position.

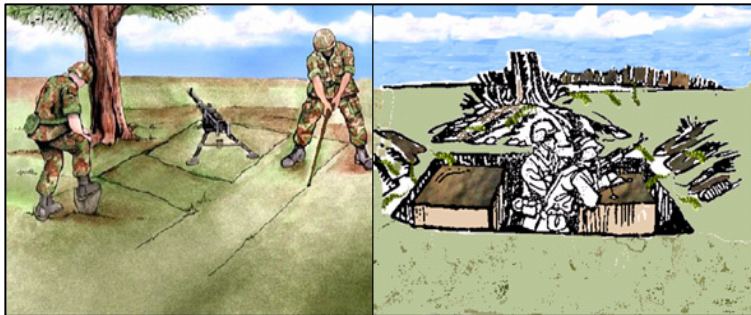


Figure 2.17. Top View – Three-Person Machine Gun Fighting Position.

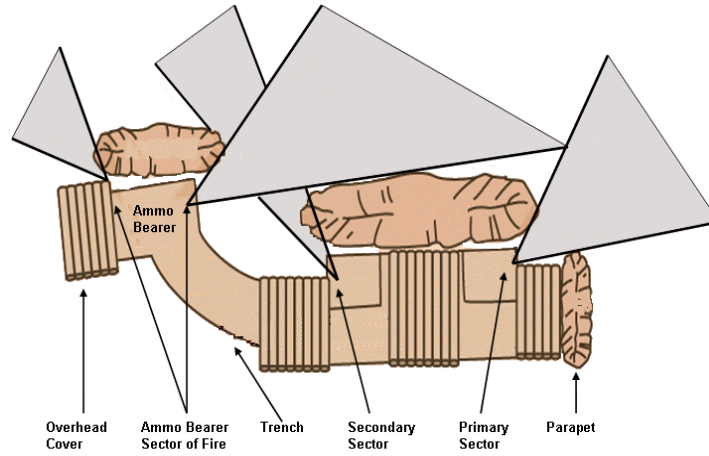
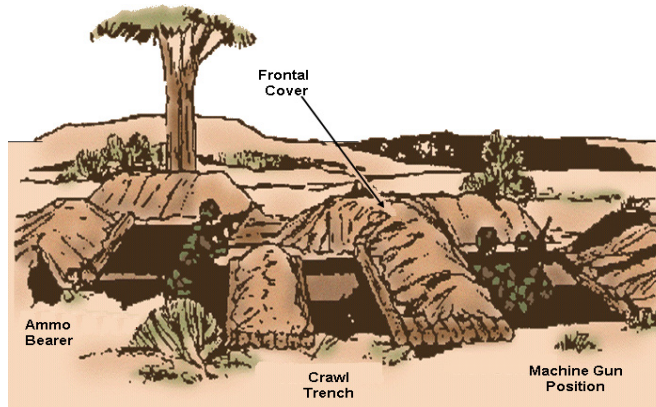


Figure 2.18. Rear View – Three-Person Machine Gun Fighting Position.

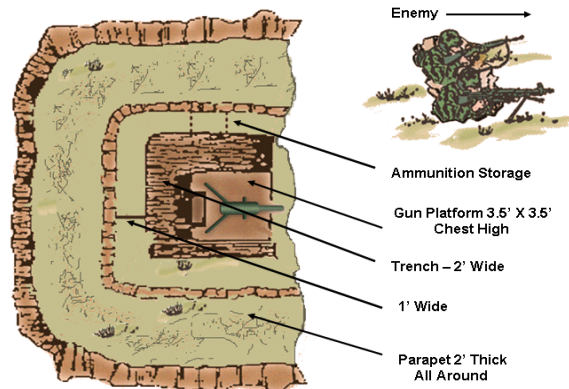


2.5.4. Modified Machine Gun Fighting Positions. When only one sector of fire is assigned for a machine gun, only one half of a position is dug, usually L-shaped (**Figure 2.19**). Time permitting, this position should be improved into a T-shaped position. Another option is the horseshoe-shaped position (**Figure 2.20**). Although the horseshoe-shaped position allows for easy 180-degree traverse across the front, it provides less frontal cover and less protection from indirect fire than the T-shaped position. For this reason, the T-shaped position is usually preferred.

Figure 2.19. L-Shaped Machine Gun Fighting Position.

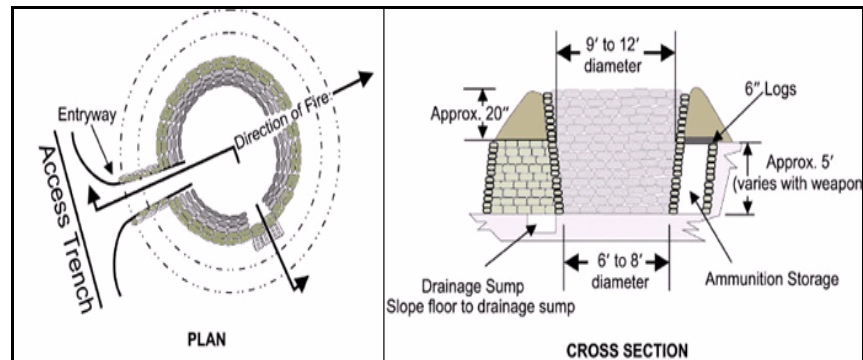


Figure 2.20. Horseshoe-Shaped Machine Gun Fighting Position.



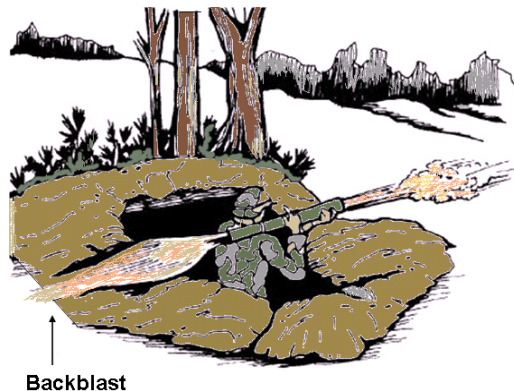
2.5.5. Mortar Position. Civil engineers may be tasked to assist in constructing mortar positions needed to defend military sites (**Figure 2.21**). These positions are constructed in a circular fashion and sized based on the weapon system to be employed. Typically, mortar positions are 6 to 8 feet in diameter at the bottom, about 5 feet deep, and have a 20-inch high berm for protection against enemy fire. These fighting positions must be dug deep enough to protect the occupants and weapons being employed without restricting direct lines of sight towards the enemy. The walls should be sloped outwards and reveted with sandbags or some other type of structural material to prevent the position from collapsing after repeated launch concussions. The upper diameter of the position can be 9 to 12 feet. Some mortar positions may not have overhead cover because of the weapon being employed, making it difficult to apply camouflage. A trench system is used for entry, and a separate position is excavated to protect the crew from enemy fire. The trench leads from the back of the mortar position away from the direction of fire, and extends for a short distance back from the position and turns at a 90-degree angle into an access trench to a covered position. The entrance trench should be reinforced to prevent collapse. Since there is no overhead cover, a drainage sump can be constructed near the entrance. Slope the floor towards the sump. This sump can also be used as a grenade sump.

Figure 2.21. Mortar Position.



2.5.6. Light Antitank Weapon (LAW) Fighting Position. Although the LAW can be fired from other fighting positions, it is best to construct a dedicated LAW fighting position that is located and designed to accommodate the backblast from the weapon (**Figure 2.22**). Site the position such that the area to the rear of the firing area is away from trees, walls, parapets, or loose gravel that could deflect the backblast or blow debris from the backblast toward other fighting positions and personnel. The LAW fighting position should be about the size of a large, straight two-person fighting position and have overhead cover located at one end of the fighting position. At the other end of the fighting position, the LAW gunner position may have a small platform for elbow rests cut into the top of the wall; the front face of the position should be inclined forward for better stability. If frontal protection is needed at the gunner's position, it should be minimal and stabilized. If there is raised rear protection, it must be low enough to ensure that the blast is not diverted toward another fighting position or back at the gunner. Also, make sure the rear wall of the fighting position is not too high for the LAW's full range of fire. This could cause the blast to become entrapped in the fighting position for elevated shots. Locate grenade sumps at both ends of the position.

Figure 2.22. Light Antitank Weapon (LAW) Fighting Position.



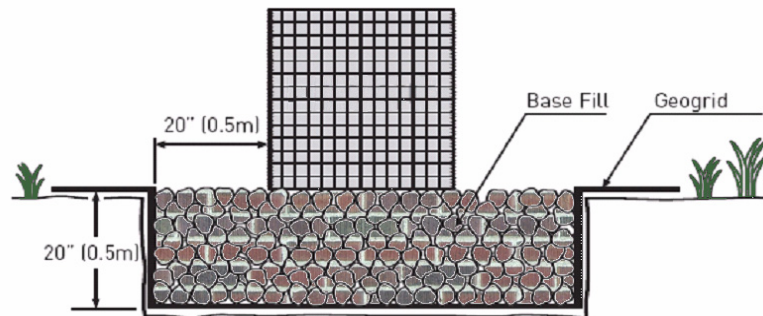
2.5.7. Aboveground Fighting Positions. Effective aboveground fighting positions can be constructed using earth-filled wire mesh containers. Some container units are made from a steel mesh framework lined with non-woven geotextile material. Their advantage over other forms of protective works includes their lightweight characteristics. They can be transported in a compressed, “accordion” style, then expanded on-site and filled with locally available material (**Figure 2.23**) such as rocks, rubble, sand, gravel, or soil. This is extremely important from a logistical standpoint. The following paragraphs describe how these units can be used to construct a small aboveground fighting position. These types of containers can also be used to construct other types of protective structures, bunkers, and revetments. Bunker construction is covered in **Chapter 3**, and revetment construction is covered in **Chapter 5**. For details on constructing different types of structures using wire mesh container units, refer to the manufacturer’s instructions, the JFOB Force Protection Handbook or the JCOB Force Protection Handbook. In addition, detailed construction drawings and instructions on building a variety of protective structures using earth-filled protective barrier can be downloaded from **TCMS**. During planning, civil engineer planners should gain access to this site and download the construction schematics and instructions needed to implement effective FP measures immediately upon arrival.

Figure 2.23. Wire Mesh Containers Being Expanded and Filled On-Site.



2.5.7.1. Site Selection and Preparation. Site selection and preparation are critical to the performance of structures built using wire mesh containers. Soil conditions and drainage patterns must be considered when siting these structures. Factors that influence deterioration of near-surface materials are elevated moisture levels, soil erosion, freeze/thaw cycles, decay of organic matter, and compression of weak soils. Wire mesh container structures transmit their loads through the “fill walls” into the foundation below. The foundation needs to be stable enough to absorb these loads. The site should be flat and level with sufficient strength and stability to support the structure for the amount of time it is needed. If a structure cannot be sited on an improved surface such as concrete, asphalt, or stabilized soil, the area should be graded to remove excess materials and loose surface soils to provide a smooth and level surface to prevent the structure from settling and shifting over time. To improve the surface area, dig a trench, approximately 20 inches beneath each wall of the structure (**Figure 2.24**). The width of the trench should extend 20 inches beyond the edge of each wall. Line the trench with a geotextile cloth (minimum weight 200 g/m²) and backfill it with a well compacted layer of coarse graded fill material or crushed rock. Test the foundation for strength and stability before starting any type of construction.

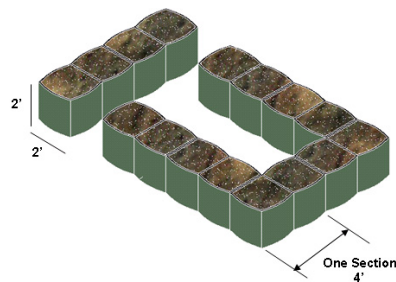
Figure 2.24. Improved Foundation.



2.5.7.2. **Materials.** Civil engineer planners must work closely with the servicing logistics function to ensure the required materials are ordered and will be available when needed. In addition, heavy equipment, such as bulldozers and front-end loaders, and hand tools (i.e., shovels, rakes, pliers, wire cutters, etc.) will be needed. As an example, the next few paragraphs describe how to construct an aboveground single-bay fighting position. **NOTE:** Always refer to the manufacturer's instructions for proper construction procedures.

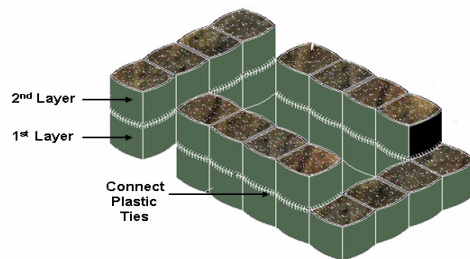
2.5.7.3. **Single-Bay Fighting Position.** To construct an aboveground single-bay fighting position using earth-filled containers, begin expanding the bays of the containers and laying out the framework ([Figure 2.5](#)) and connecting the joining pins. Make sure the flaps at the bottom of the units are folded out. Once these actions are completed, begin placing fill material in the center of the bays uniformly throughout the first layer. Generally, the bays are filled in lifts no greater than 9 inches and lightly compacted using manual hand tampers or by foot – do not use compacting equipment for this purpose. The bays should bulge along the sides while filling. This allows them to deform to their maximum state. Do not attempt to use restraints to prevent this deformation process. To accommodate deformation, pull the coil hinges located at the bottom of the bays out approximately 4 inches during initial filling. If the containers being used do not have coil hinges at the bottom of the bays, just pull the sides of each bay outwards. Since the example being used here involves constructing an aboveground single-bay fighting position, a second layer will be constructed on top of the first layer. When a second layer is to be constructed, halt filling approximately 4 inches from the top of each bay.

Figure 2.25. First Layer – Single-Bay Fighting Position.



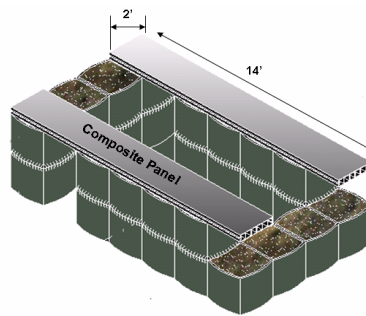
2.5.7.4. **Second Layer.** After the first layer is complete, align the second layer as depicted in [Figure 2.26](#). Seal both layers together using the geotextile flaps located at the bottom of the second layer and use the plastic ties to connect them. Uniformly fill the second layer as previously described.

Figure 2.26. Second Layer – Single-Bay Fighting Position.



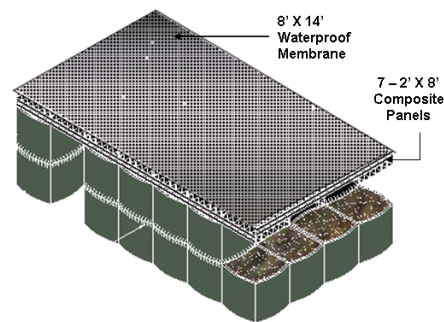
2.5.7.5. **Composite Panels.** Align the 2- by 14-foot composite panels on top of the second layer of earth-filled units along the vertical walls as shown in [Figure 2.27](#).

Figure 2.27. Composite Panels – Single-Bay Fighting Position.



2.5.7.6. **Waterproof Membrane.** Place the 2- by 8-foot composite panels on top of the roof supports and connect them using the toggle connectors. Drive the toggle connectors in as far as possible, cut them flush, then place the waterproof membrane on top of the roof as illustrated in [Figure 2.28](#).

Figure 2.28. Waterproof Membrane – Single-Bay Fighting Position.



2.5.7.7. **Overhead Cover.** Constructing overhead cover is the last step. Begin by aligning sections of containers along the roof as shown in [Figure 2.29](#). Ensure the flaps at the bottom of the units are folded in. Fill the bays as previously described and lightly compact. After all of the bays are filled, place approximately 2 feet of fill material in the center of the roof to complete overhead cover ([Figure 2.30](#)). Once completed, check to make sure there is no excessive deflection of the roof (up to 1½ inches is acceptable). Also, make sure the roof supports are centered on the sidewalls and sheet pilings are fully supported by the roof supports. Lastly, check to make sure all walls are straight and that there is no excessive settlement of the walls.

Figure 2.29. Overhead Cover – Single-Bay Fighting Position.

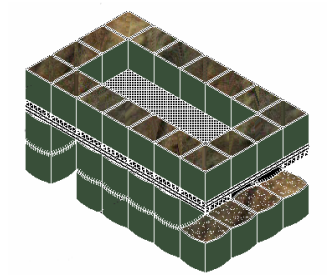
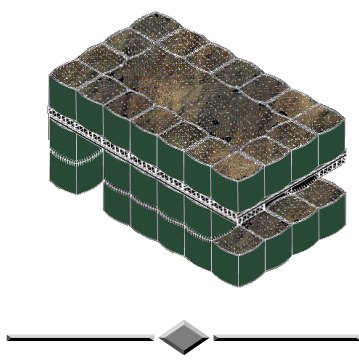


Figure 2.30. Completed Single-Bay Fighting Position.

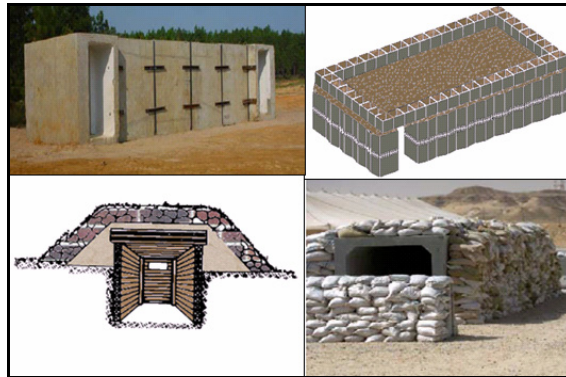


Chapter 3

PROTECTIVE STRUCTURES

3.1. Overview. This chapter covers different types of bunkers and shelters that can be employed in the expeditionary environment (**Figure 3.1**). Bunkers and shelters should be designed to withstand near misses or direct hits from rockets, artillery, and mortars and strategically located throughout the site. The types of protective shelters employed during contingencies are based on many factors including: (1) the threat, (2) stage of the deployment, (3) intended use of the structure, (4) available materials, (5) available equipment, (6) available man-hours, and (7) construction skills. During initial beddown, engineers must focus immediately upon designing and constructing protective shelters needed to counter known and potential threats. Initially, expedient methods will likely be required. However, as contingency operations begin to stabilize and access to additional resources become available, engineers must focus on improving designs and constructing protective shelters that afford more protection for personnel and mission-critical assets. While planning, keep in mind that the best protective shelters are those that provide the most protection and require the least amount of time and effort to construct.

Figure 3.1. Protective Structures.

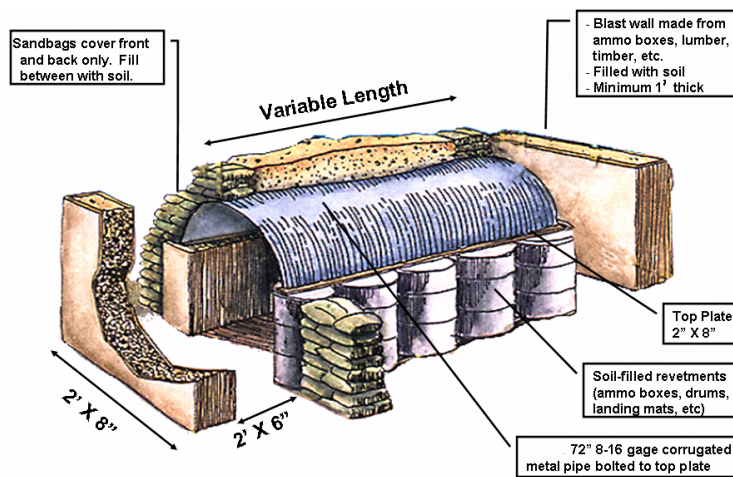


3.2. Expedient Protective Structures. When designing bunkers and shelters, consider the purpose (e.g., command post, observation post) and the degree of protection desired (small arms, mortars, bombs). These structures should be sited and constructed out of the path of natural drainage lines. If possible, site shelters on reverse slopes, in wooded areas, or in some form of natural fortification such as a ravine, valley, gully, hollow or depression for added protection. **NOTE:** Reverse slopes of hills and mountains also provide some protection from the effects of nuclear weapons since the heat and light from the fireball of a nuclear blast and the initial radiation tend to be absorbed by hills and mountains. For additional information on NBC protection, refer to AFTTP (I) 3-2.46. Once constructed, continuously improve the protective capability of bunkers and shelters as time permits. The following paragraphs outline key factors to be considered when designing and constructing expedient protective structures.

3.2.1. Overhead Protection for Expedient Protective Structures. Expedient shelters should have some type of overhead cover. Although it may not be possible to provide overhead cover for every asset, fighting positions and mission-critical assets deemed vulnerable to certain threats must be provided appropriate levels of protection. Overhead cover can be constructed from a combination of berms, revetments, or partially buried structures if engineers are not limited by the lack of time or resources. During the initial stages of a deployment, however, it is very likely that time and resources will be limited. This is why it is very important that civil engineers focus initially on defeating specific threats (e.g., direct- and indirect-fired weapons) and protecting the most critical assets, rather than attempting to equally protect all assets from all possible threats. See [Attachment 2](#) for a list of the different types of materials that may be available in the expeditionary environment for use in constructing overhead cover to protect against various projectiles.

3.2.2. Corrugated Metal Culvert Shelter. Aboveground metal culvert shelters can be constructed in areas where personnel are billeted or work in non-protected buildings or expeditionary structures and need shelter in the event of an attack (**Figure 3.2**). Covered with earth (18 to 24 inches), these structures can provide a significant amount of protection. However, do not use the top of these types of structures to support overhead cover without first reinforcing the base of the structure. Use lumber, timber, berms, revetments, or other expedient means of supporting the overhead cover. The shelter is 6 feet high and consists of two rows of 55-gallon drums with about a 4-foot span between rows. Two- by four-inch studs measuring 4 inches higher than the drums are centered inside each drum. The drums are then filled with soil. A 2- by 8-inch top plate is connected to the 2- by 4-inch studs lengthwise through the bunker. The corrugated metal pipe halves are bolted together and connected to the top plates. A 2-foot layer of sandbags is placed along each row of drums. To protect the ends of the bunker, erect barrier walls 2 feet beyond the entrances. Additional protection is provided on the sides and ends by increasing sandbag thickness. This shelter provides protection against mortars and small caliber weapons.

Figure 3.2. Corrugated Metal Culvert Shelter.



3.2.3. Fighting Bunker With Overhead Cover. It is impractical to place enough earth cover on a structure to protect it against all weapons. However, by combining materials and using them in layers, protection is provided with less excavation and effort. The designs illustrated in [Figure 3.3](#) through [Figure 3.5](#) use five 2-inch or seven 1-inch layers of lumber as the base support for the roof. Layers of materials are placed on the base in sequence to provide overhead protection. [Table 3.1](#) and [Table 3.2](#) contain a bill of materials and required stringer thickness based on the thickness of earth cover for this design. These different layers are described in the following paragraphs.

3.2.3.1. Dust-Proof Layer. Tar paper, canvas, or tarpaulins are lapped and placed on top of the base of the roof to keep out dust and dirt.

3.2.3.2. Cushion layer. The cushion layer is intended to absorb the shock of detonation or penetration. Untamped earth is the best material for this purpose and should be at least 12 inches thick. Materials such as loose gravel transmit shock to the layer below and should not be used in the cushion layer. This layer extends on all sides for a distance equal to the depth of the shelter floor below the ground surface, or to a minimum of 5 feet.

3.2.3.3. Waterproof Layer. The waterproof layer is constructed of the same or similar materials as the dust-proof layer. It is intended to keep moisture from the cushion layer in order to retain the cushioning effect of the soft, dry earth and minimize the dead load the structure must carry.

3.2.3.4. Burster Layer. The burster layer is intended to cause a projectile to detonate before it can penetrate into the lower layers. This layer is made of 6 to 8 inches of rocks placed in two layers with the joints broken. It should be at least 12 inches thick. Irregular-shaped rocks are more effective for this purpose than flat rocks because they can change a projectile's angle of penetration. If rocks are not available, 8-inch logs can be used. They must be wired tightly together in two layers. The burster layer should extend on each side of the shelter a minimum of 6 feet. Lastly, cover the burster layer with two inches of untamped earth or sod as a camouflage layer.

Figure 3.3. Top View – Fighting Bunker.



Figure 3.4. Front View – Fighting Bunker.

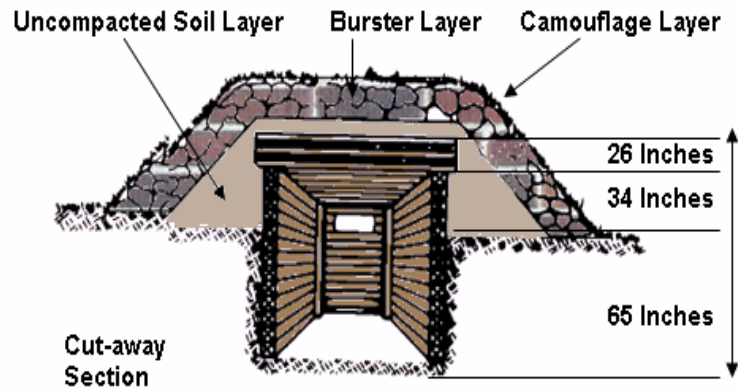


Figure 3.5. Layout and Design – Fighting Bunker.

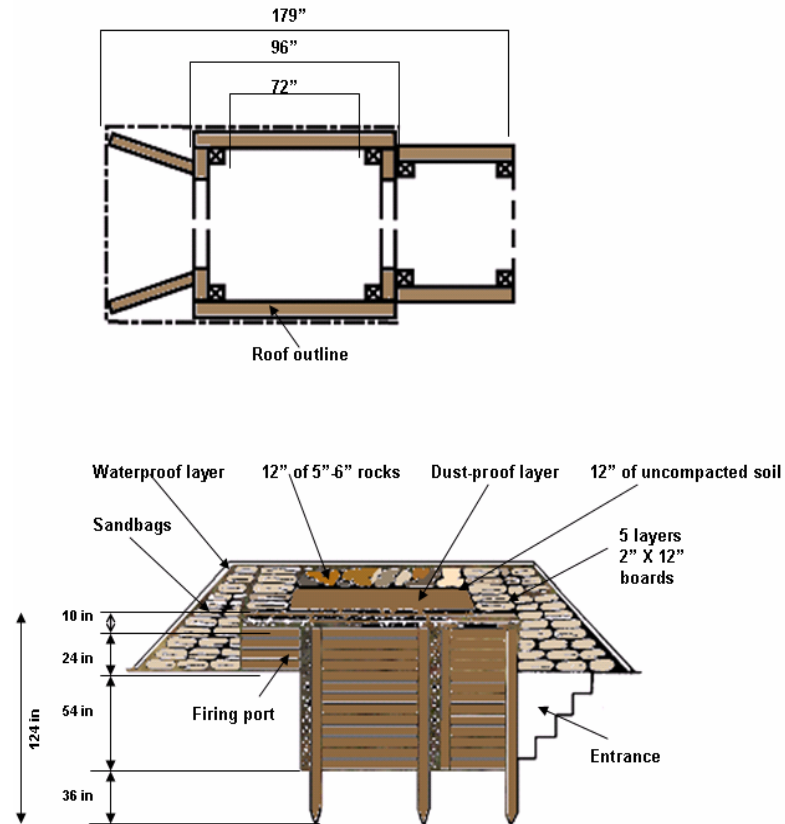


Table 3.1. Fighting Bunker Bill of Materials.

Nomenclature	Description	Qty
Roof	Lumber (2" x 12" x 6'11")	48 pcs
Sidewalls	Lumber (2" x 12" x 14'11")	14 pcs
Entrance Wall	Lumber (6" x 6" x 7'11")	26 pcs
Firing Port and Entrance Door	Lumber (6" x 6" x 4')	26 pcs
Front and Rear Walls	Lumber (6" x 6" x 4'11")	13 pcs
Firing Port and Retaining Wall	Lumber (6" x 6" x 3'3")	3 pcs
Side Post	Lumber (6" x 6" x 9'4")	6 pcs
	Lumber (6" x 6" x 6'5")	
Sandbags		300 ea
Roofing Paper	100 SF rolls	3 ea
Driftpins	1/2" x 12"	210 ea
Nails	16d	30 lbs

Table 3.2. Thickness of Wood to Support Earth Cover.

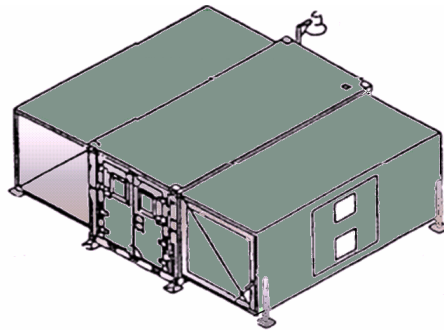
Thickness of earth cover (feet)	Span width (feet)					
	2 1/2	3	3 1/2	4	5	6
1 1/2	1	1	2	2	2	2
2	1	2	2	2	2	3
2 1/2	1	2	2	2	2	3
3	2	2	2	2	2	3
3 1/2	2	2	2	2	3	3
4	2	2	2	2	3	4

Note: Stringers should extend from support to support in all layers. Adjoining edges should be staggered from one layer to the next.

3.3. Prefabricated Structures. Prefabricated structures provide a rapid construction and placement capability. The most commonly used prefabricated structures are the International Organization for Standardization (ISO) shelters and ISO shipping containers.

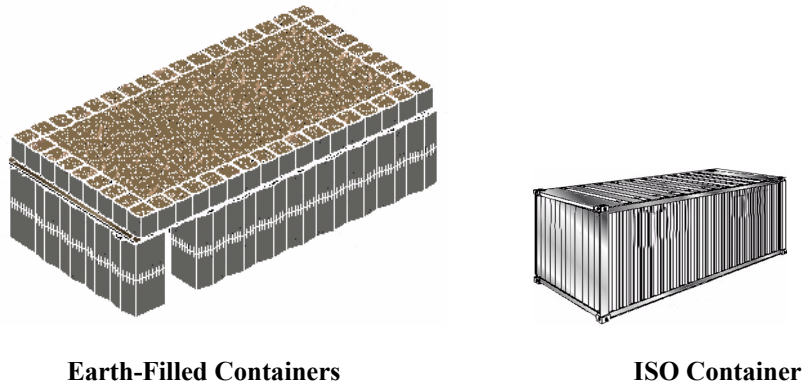
3.3.1. Expandable Tactical ISO Shelters. ISO shelters (**Figure 3.6**) are not as vulnerable to blast and fragmentation as tents and provide highly mobile, environmentally controlled space for a variety of field activities. Several models are available, including non-expandable, one-side expandable, and two-side expandable models. Tactical shelters are wired for 60 or 100 amp, three-phase electrical distribution and are integrated with internal fluorescent lights, 120 VAC, 20 amp electrical outlets, an external area light, and an interface for external environmental control units. Although research is constantly being conducted to develop designs that are capable of resisting the effects of blast and fragmentation, tactical shelters can be hardened with sandbags, revetments, berms, concrete barriers, or other methods to provide some degree of protection. For additional details on the use of tactical shelters, refer to AFH 10-222, Volume 6. DOD also established a Joint Committee on Tactical Shelters (JOCATAS) to prevent the duplication of tactical shelter research and development amongst the services. JOCATAS is also responsible for approving the DOD Standard Family of Tactical Shelters. Additional information on JOCATAS and approved shelters can be found at: <http://nsrdec.natick.army.mil/jocotas>.

Figure 3.6. Expandable Tactical Shelter.



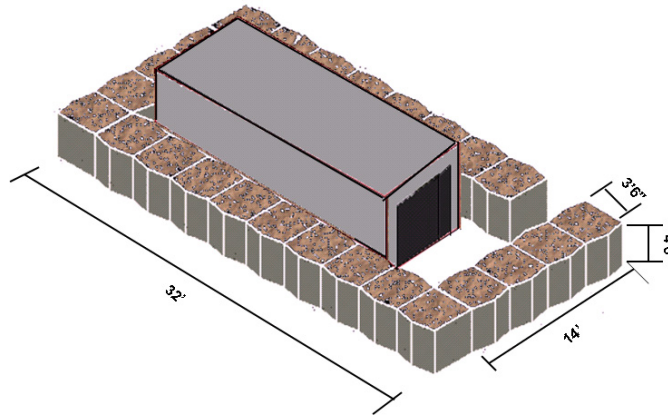
3.3.2. ISO Bunkers. ISO bunkers are constructed using ISO containers hardened with earth-filled protective barriers (**Figure 3.7**). The following paragraphs briefly describe construction of an ISO bunker. There are several different types of bunkers that can be constructed using earth-filled containers. For additional information on ISO bunkers and other types of bunkers that can be constructed using ISO containers, refer to the manufacturer's instructions and TCMS. The next few paragraphs describe construction of an above-ground 20-foot ISO bunker. **NOTE:** When building these types of bunkers, keep in mind the ISO containers cannot be load-bearing structures. Steel framing or other structural support approved by an engineer with experience in structural analysis must be used to support the top cover. Before attempting to construct this bunker, planners must ensure the resources are available to complete all phases of the project. These resources include bunker kits; heavy equipment such as bulldozers, vibratory rollers, dump trucks, cranes, forklifts, and front-end loaders; and technical guidance. Once a site is selected, follow the guidance in **Chapter 2** for site selection and preparation. Construction can begin once planners are satisfied all resource requirements have been met.

Figure 3.7. ISO Bunker.



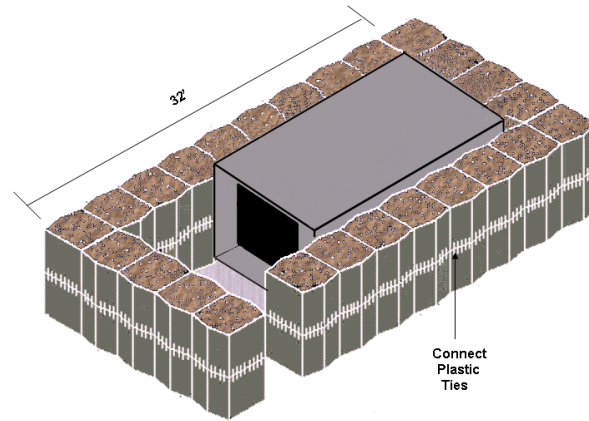
3.3.2.1. **First Layer.** The first layer of wire mesh containers for the ISO bunker requires three sections of containers equal to nine bays. Begin by collapsing one of the nine-bay sections to make a section that is eight bays long. Next, break down another nine-bay section into two units with four bays each. Align the bays as illustrated in [Figure 3.8](#), ensuring the flaps at the bottom of the units are folded out. Once the layout is complete, begin filling the units in 9-inch lifts (approximately). Start from the center of the bays and fill the bays in a uniform manner, ensuring some bays are not being filled faster than others. Lightly compact the fill material after each lift using manual hand tampers or by foot – do not use compacting equipment for this purpose. Continue this process until all bays are filled. Compact the last layer in preparation to construct the second layer of the ISO bunker. For more guidance on infill procedures, refer to [Chapter 2](#), the manufacturer’s instructions, or TCMS.

Figure 3.8. First Layer – ISO Bunker.



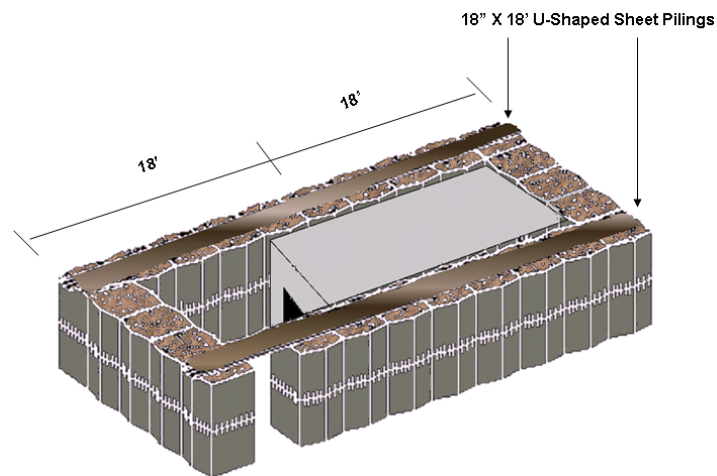
3.3.2.2. **Second Layer.** The second layer of the ISO bunker also requires three sections of containers (nine bays per section). Note that the material needed to construct the second layer is identical to the material needed to construct the base layout. This is because the second layer must be perfectly aligned with the first layer. Once again, begin by collapsing one of the three sections (nine bays) to make a section that equates to eight bays. Take another section (nine bays) and separate it into two separate sections consisting of four bays. Align these sections as illustrated in [Figure 3.9](#), ensuring the flaps at the bottom are folded out. Once the layout is complete for the second layer, connect the plastic ties between the first and second layers, and begin filling the units using the proper fill procedures previously described.

Figure 3.9. Second Layer – ISO Bunker.



3.3.2.3. Roof Support. Once the second layer is complete, begin preparing the roof support. To support the roof structure, four 18-foot, U-shaped sheet pilings are required. Place two pieces of the sheet pilings end-to-end on top of each of the sidewalls of the structure as illustrated in [Figure 3.10](#). Ensure the panels are centered on the sidewalls. Other materials such as 6- by 6-inch lumber can be used in lieu of sheet pilings for roof support if approved by an engineer with experience in structural analysis. This structure will be depended upon to shield personnel from attacks, and its structural integrity cannot be overemphasized. For this reason, any tendency to improvise materials or procedures during construction should be avoided.

Figure 3.10. Roof Support — ISO Bunker.



3.3.2.4. **Sheet Piling and Waterproof Membrane.** Once the sheet pilings are firmly in place along the sidewalls, 24 18-foot U-shaped sheet pilings are laid across the structure, firmly on top of the roof supports as illustrated in [Figure 3.11](#). When placing the sheet pilings, slide the pieces together from the ends to lock them in place. Again, any attempts to improvise should be avoided, and any material substitution should be approved by an engineer with experience in structural analysis. Once the sheet pilings are in place across the structure, the waterproof membrane can be placed on top of them. Sandbags can then be placed on top of the waterproof membrane to level the roof ([Figure 3.12](#)).

Figure 3.11. Sheet Piling – ISO Bunker.

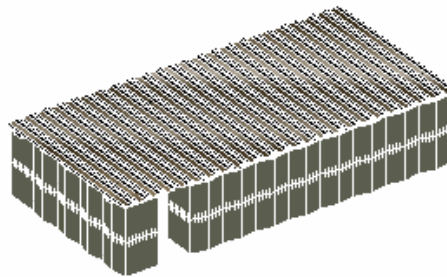
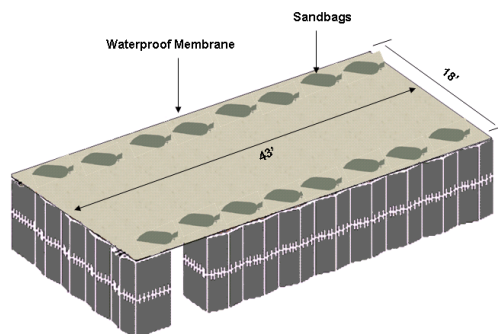


Figure 3.12. Waterproof Membrane – ISO Bunker.



3.3.2.5. **Overhead Cover.** After installing the waterproof membrane, the next step is to put the overhead cover in place. This requires 24 sections of containers, 2 feet high, 2 feet wide, and 4 feet long. Place the units as illustrated in [Figure 3.13](#), making sure the sandbags are beneath the edges of the units to prevent soil from leaking through and on to roof. Fill each unit with loose soil and lightly compact. Once this is complete, place approximately 2 feet of soil in the center of the roof. Once this is completed, refer to [Table 3.3](#) and do a quick visual check to make sure the structure is intact.

Figure 3.13. Overhead Cover – ISO Bunker.

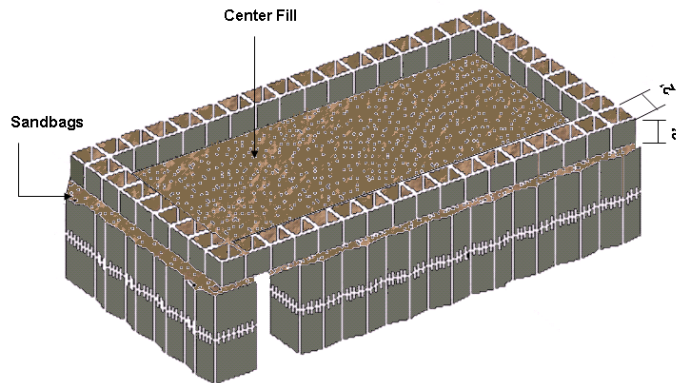
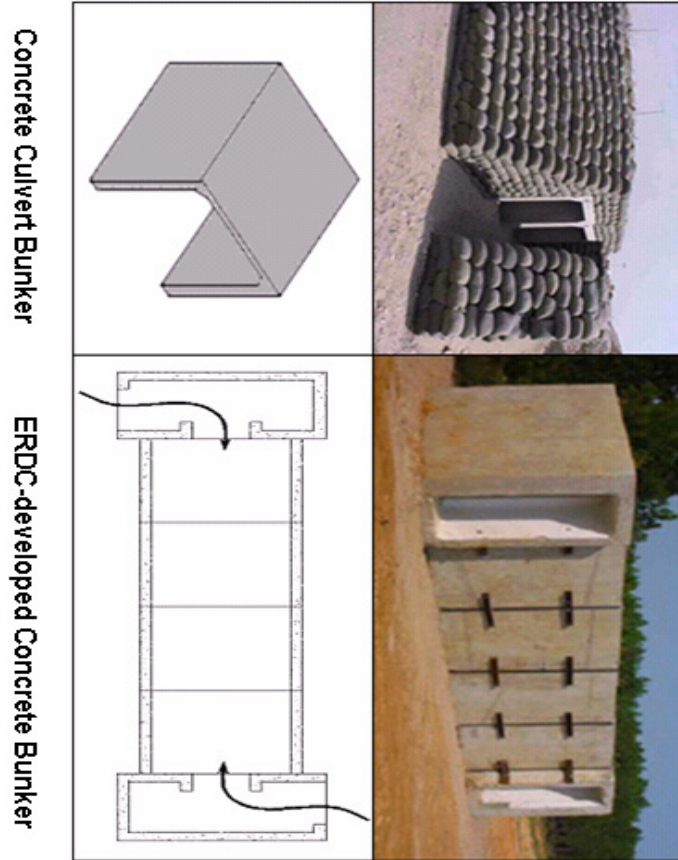


Table 3.3. Visual Checklist – ISO Bunker.

1	Make sure there is no excessive deflection of the roof (up to 1 ½ inches is acceptable)
2	Make sure the roof supports are centered on the sidewalls
3	Make sure sheet pilings are fully supported by the roof supports
4	Make sure all walls are straight
5	Make sure there is no excessive settlement of the walls

3.4. Reinforced Concrete Bunkers. Reinforced concrete bunkers are used extensively in the expeditionary environment to provide immediate shelter from imminent or repeated attacks. **Figure 3.14** shows reinforced concrete culvert bunkers commonly found in SWA and a different type of reinforced concrete bunker developed by the USACE's Engineer Research and Development Center (ERDC). The entrances of reinforced concrete culvert bunkers can be blocked by concrete barriers, additional sandbags, or some other barrier to prevent the effects of blasts and fragmentation from entering the structure. The ERDC bunker is designed to eliminate a direct line of entrance for blast and fragmentation into the structures. These structures are usually designed to accommodate 25 to 30 personnel and can be placed above or below the ground (based on the threat). It is important to note that these bunkers are not effective against direct hits from 120 mm mortars and 122 mm rockets. Therefore, these bunkers should be fully buried in a cut and cover configuration or covered by several layers of sandbags. Cover the roof of the bunkers with 2 to 3 layers of sandbags for protection against quick-fused 82 mm and 120 mm mortars. Cover bunkers with approximately 48 inches of sandbags or bury them with approximately 48 inches of soil cover for protection against quick-fused 122 mm rockets. Place at least layers of sandbags along the bunker walls for protection against blast and fragmentation effects of near-miss (4 feet) hits from 82 mm and 120 mm mortars and 122 mm rockets. Reinforced concrete bunkers can be manufactured locally or acquired through the Logistics Support function. For additional information on these and other types of bunkers, obtain access to TCMS. The ERDC should also be contacted at www.erdcd.usace.army.mil for the latest designs since these structures are constantly being tested and improved.

Figure 3.14. Reinforced Concrete Bunkers.



Chapter 4

OBSTACLES

4.1. Overview. Obstacles, from a tactical military perspective, can be described as any obstructions designed and employed to impede, oppose, block, or disrupt the movement or intentions of an opposing force. They can exist naturally, be expediently constructed, or be prefabricated and moved into place when and where needed. While the employment of obstacles can have significant advantages, constructing them can be labor-intensive, and they can inhibit the movement of both enemy and friendly forces. For this reason, obstacles must be employed with a clear goal and understanding. This chapter covers many types of obstacles that can be employed in the expeditionary environment to protect assets and enhance force protection efforts. For additional details, refer to MIL-HDBK-1013/10, *Design Guidelines for Security Fencing, Gates, Barriers, and Guard Facilities*, and UFC 4-022-02.

4.2. Planning. Responsibility for developing a plan for using obstacles, the barrier plan, normally rests with civil engineers and security forces. The plan outlines how obstacles will be employed continuously and during periods of heightened alert. A prioritized list of key facilities and critical assets to be protected is used to develop the plan. Civil engineers work closely with security personnel to identify resources needed to adequately protect key facilities and assets. Although some installations may preposition these assets and employ them upon heightened alert or increased threats, in the expeditionary environment, limited resources may not allow for maintaining barriers in storage or prepositioned status for heightened alert. Barriers may need to be employed where needed continuously to provide protection in high threat environments. This determination is made on-site. The barrier plan should summarize the number and types of barriers employed as well as additional requirements, employment locations, if and where barriers will be prepositioned, their intended purpose (i.e., traffic control, perimeter security, etc.), and resources and equipment needed to move or relocate and install the barriers when needed (i.e., anchors, cables, forklift, trailer, etc.). A dedicated barrier team should be appointed, trained, and exercised regularly.

4.3. Natural Obstacles. Natural obstacles can include steep slopes, escarpments, ravines, gullies, ditches, rivers, streams, canals, swamps, marshes, snow, and trees (see [Table 4.1](#)). Trees between 6 to 8 inches in diameter, dense shrubs, and other vegetation can be used to enhance efforts to restrict access to military sites. If complemented with other forms of barriers such as barbed or concertina wire ([Figure 4.1](#)), trees and dense vegetation can be used to enhance standoff. Barbed wire can be run low (9 to 30 inches above the ground) in tall grass, shrubs, or brush and anchored on small pickets or draped through shrubs to cause tripping hazards and injury to enemy personnel attempting to encroach upon a military site. Dense trees and shrubs can also obscure direct lines of sight to a location and decrease the enemy's targeting capability. Keep in mind a clear zone must always be maintained to prevent enemy personnel from advancing too close to the site's perimeter. There are some disadvantages of using trees and shrubs for the purposes just covered. In some regions, trees and shrubs can be labor-intensive to maintain. Also, these natural barriers can be used by the enemy as cover while attempting to breach protective barriers. An analysis will have to be conducted to determine if trees and vegetation can be used to enhance force protection efforts, or whether these areas will have to be cleared to prevent the enemy from gaining an advantage in efforts to breach security measures.

Figure 4.1. Existing Barrier Complemented With Barbed Wire.



Table 4.1. Description of Natural Obstacles.

OBSTACLE	DESCRIPTION
Steep Slopes	Steep slopes, particularly those with ruts, brush, and felled trees, can stop movement of different types of vehicles.
Escarpments	Vertical or near-vertical 1 1/2-meter high cuts in slopes or walls can be used to stop vehicles. Thick rock walls, railroad embankments, and steep fills along highways are examples of escarpments that can be used.
Ravines, Gullies, and Ditches	These obstacles can stop most wheeled vehicles. However, they should be over 5 meters wide to be effective against tracked vehicles.
Rivers, Streams, and Canals	To overcome rivers, streams, and canals, an enemy force must find a fordable shallow crossing, rely on special means for deep water fording, or find an elevated crossing. The width and depth of the water, the water velocity, and the condition of the banks and the bottom of the water determine the ease of crossing by shallow or deepwater fording.
Swamps and Marshes	These natural barriers are effective obstacles to mobility. They can stop personnel and all types of vehicles when there is either no firm ground or the submerged ground is more than a meter below the water surface.
Snow	Snow over one meter in depth can be a major obstacle for personnel and vehicles.
Trees	Heavy stands of trees, eight or more inches in diameter and spaced less than 20 feet apart will build up into an obstacle when tracked vehicles attempt to push them over and force their way through.

4.4. Field Expedient Obstacles. During initial beddown it may be necessary to use whatever means available to construct obstacles for protection. However, once material and equipment are more readily available, these measures should be complemented or replaced with more effective means of protection. The following paragraphs describe expedient methods that can be used to construct and employ obstacles when time and materials are limited.

4.4.1. **Abatis.** During initial beddown, trees can be used to construct an *abatis*, one of the oldest forms of barriers (**Figure 4.2**). The term “abatis” is a French word meaning “a heap of material thrown.” It is constructed by cutting down trees, leaving them attached to the stump, and arranging them in a row with the branches facing towards the direction of the enemy to impede movement. To ensure the tree remains attached to the stump, cut the butt of the tree two-thirds through on the opposite side to which it is to fall. The trees are then forcefully pushed over in the required direction. The branches can be sharpened, making the barrier a primitive version of barbed wire. To be even more effective, tree branches can be interlaced with barbed wire if available. Although this type of expedient barrier may be necessary during the early stages of a contingency due to severely limited resources, it should not be used as a permanent barrier for a deployed site unless combined with more modern forms of obstacles to enhance the level of protection.

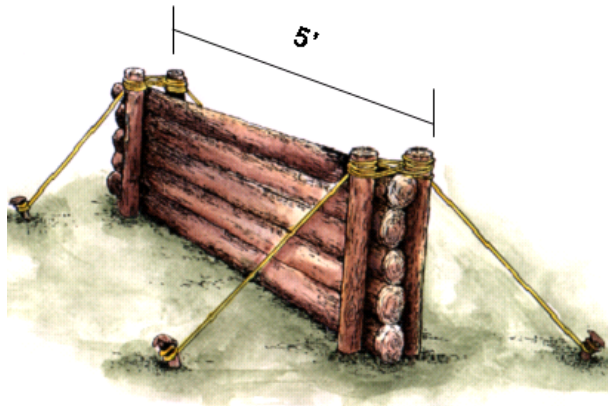
Figure 4.2. Abatis.



4.4.2. Log Obstacles. During initial beddown, logs can be used to construct different types of obstacles and expedient barriers. The following paragraphs describe some of the different ways logs can be used to restrict movement around and throughout a deployed location. These are considered temporary measures. Once contingency operations begin to stabilize and material and equipment are more readily available (locally or through supply channels), these types of barriers should be complemented or replaced with more effective means of impeding, blocking, or disrupting movement. Some of these methods will be covered later in this chapter.

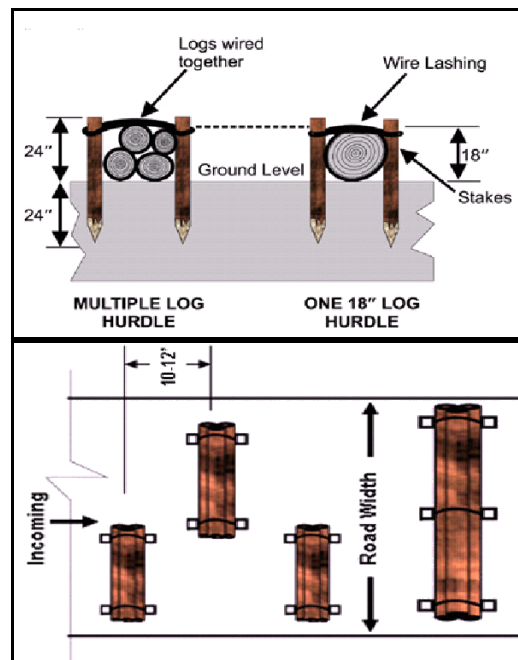
4.4.2.1. Log or Lumber Wall. A log wall, as illustrated in [Figure 4.3](#), can be constructed to block access to certain areas or to protect critical assets. This type of barrier construction consists of short sections of 4- to 6-inch logs or lumber stacked together between posts of the same size as the wall sections. The posts are fastened together at the top and further held in place by guy wires or ropes fastened to stakes. Several 10- to 12-foot wall sections should be constructed toward the front of the position and placed in a staggered fashion rather than building one long wall which could be destroyed by a single detonation from enemy weapons.

Figure 4.3. Log Wall.



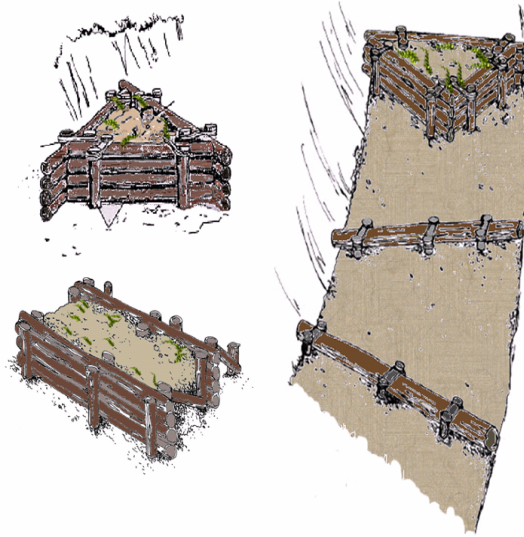
4.4.2.2. **Log Hurdles.** Log hurdles are used to form barriers approximately 18 inches high across a road. Individual logs may be as small as 10 inches in diameter if they are lashed or wired together and staked in place. Once log hurdles are wired together, stagger shorter logs (6- to 7-foot lengths) along the path in 10 to 12-foot segments, and place full width logs as illustrated in [Figure 4.4](#). Hurdles can slow vehicles enough to allow security forces to engage an intruder or cause a vehicle to lose control. For more effectiveness, hurdles can be used in conjunction with other obstacles such as ditches and log cribs.

Figure 4.4. Log Hurdles.



4.4.2.3. **Log Cribs.** Log cribs are simple obstacles consisting of short sections of logs (or other materials such as steel planks if available) fashioned together as bins to contain dirt or rocks. Log cribs can be rectangular or triangular and are used to block vehicle paths of travel on narrow roads (**Figure 4.5**). When possible, fill the cribs with material excavated by digging a shallow ditch in front of the cribs. Anchor revetment materials to prevent them from being easily pushed out of the way. These obstacles are effective against wheeled and tracked vehicles, especially in restricted areas like narrow mountain roads. Unless substantially built, these types of obstacles are not effective against heavy tracked vehicles. To make these obstacles more effective, log hurdles can be constructed ahead of the cribs to force vehicles to slow down prior to encountering them.

Figure 4.5. Log Cribs.



4.4.3. **Expedient Posts.** The next few paragraphs cover different types of posts that can be used to block access roads either permanently or temporarily. The method used will depend on many factors, including the need for access by friendly forces, the threat, availability of equipment and materials, and the need to maintain an active offensive and defensive capability.

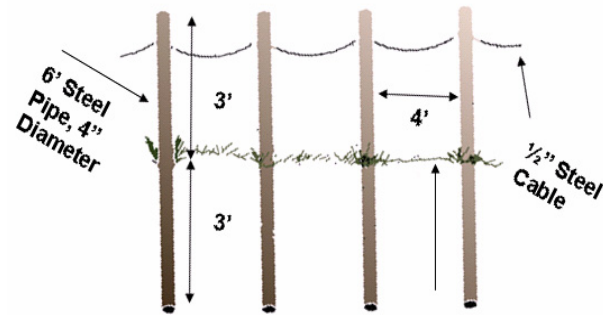
4.4.3.1. **Timber Posts.** Timber posts can be used to stop vehicles if partially buried and driven into the soil at an angle between vertical and 50 degrees toward the direction of movement (**Figure 4.6**). The posts should be approximately 10 feet long and extend 3 1/2 to 4 feet aboveground. Set the posts between 3 to 4 feet apart in rows with 10 feet between rows. They can be either aligned or staggered. Logs should be a minimum of 5 inches in diameter for hardwoods and about 10 inches in diameter for softwoods. Wire entanglements can be used in conjunction with this measure for increased effectiveness.

Figure 4.6. Timber Posts.



4.4.3.2. **Steel Angled Posts.** Steel pipes can be used as posts to block roadways and entrances. The pipes should be approximately 6 feet long and 4 inches in diameter. They are spaced approximately 4 feet apart and driven into the surface approximately 3 feet at an angle between 30 to 45 degrees. The post holes can then be backfilled with either soil or concrete to increase their strength. Vehicles attempting to penetrate these types of barriers at high speeds will experience major damage, and occupants will more than likely be severely injured. Steel angled posts can be installed parallel or perpendicular to a roadway. To prevent access by individuals on motorcycles, drill holes into the top of each post and thread $\frac{1}{2}$ -inch diameter steel wire cable through each post as indicated in [Figure 4.7](#).

Figure 4.7. Steel Angled Posts.



Backfill holes with soil or concrete

4.4.4. **Berms and Ditches.** Civil engineers should include expedient construction of shallow berms and ditches while planning beddown activities for deployments ([Figure 4.8](#)). Constructing these terrain features around the perimeter of a deployed location will slow or prevent vehicles from penetrating the restricted boundary. It is important to remember that these features should be gradual and shallow. Shallow berms and ditches make it more difficult for speeding vehicles to avoid and provide less cover for intruders attempting to infiltrate the area. While planning, consider the different types of heavy equipment that will be required to construct berms and ditches.

4.4.4.1. **Triangular Ditches and Hillside Cuts.** Triangular ditches and hillside cuts are relatively easy to construct and are very effective against a wide range of vehicles. Hillside cuts are variations of the triangular ditch adapted to hillside locations. These terrain structures may need to be reveted to prevent them from being easily filled or collapsed. Constructing additional obstacles, such as log hurdles (protected side) to complement these structures, will make them more effective in slowing and stopping vehicles ([Figure 4.9](#)). When placed at blind curves or hilltop transitions, log hurdles or spoil mounds can cause speeding vehicles to go out of control.

4.4.4.2. **Trapezoidal Ditch.** A trapezoidal ditch requires more construction time, but is more effective in stopping vehicles. With this type of construction, a vehicle will be trapped when the front end falls into the ditch and the undercarriage is hung up on the leading edge of the ditch.

4.4.4.3. **Berms.** Berms are very effective in reinforcing existing perimeter structures and stopping vehicles, and are relatively easy to construct. However, this task can also be time-consuming, and engineers need to ensure heavy equipment will be available to construct berms immediately upon arrival to the deployed location.

Figure 4.8. Berms and Ditches.

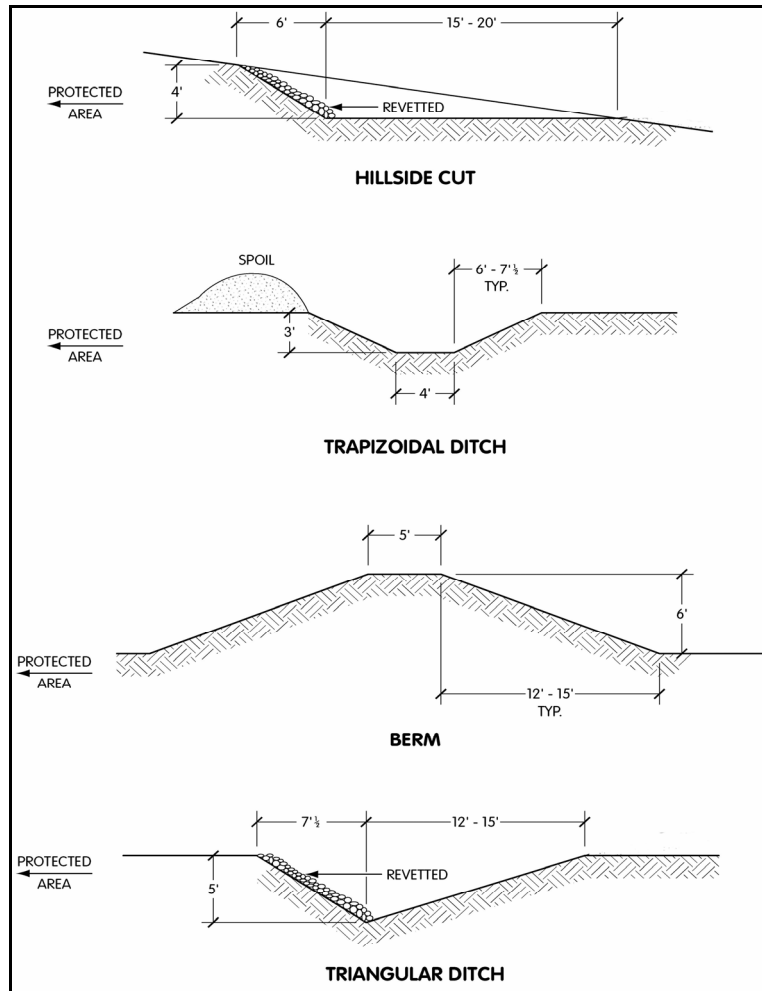
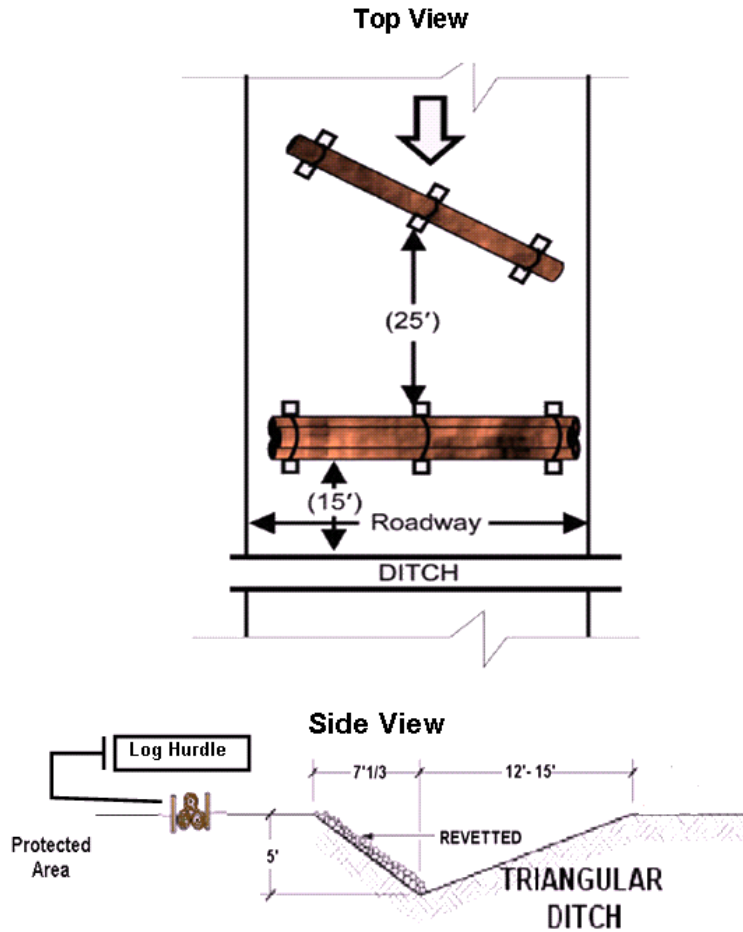
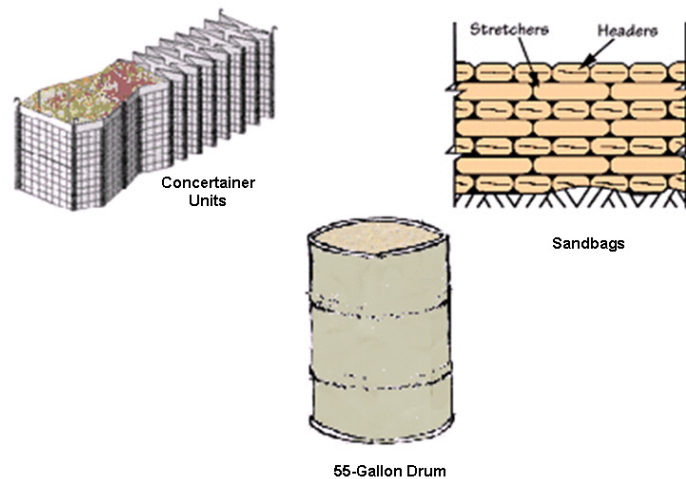


Figure 4.9. Employing Additional Obstacles With Triangular Ditch.



4.4.5. Earth-Filled Obstacles. Field expedient methods for constructing obstacles such as log cribs can be very effective and necessary, particularly when a unit is on the move or simply does not have access to other types of materials. However, these methods can be labor-intensive and time-consuming. If available, prefabricated materials can also be filled with earth and used as obstacles. Examples of some prefabricated objects that can be used along with sand, soil, rocks, or other natural materials include wire mesh containers, sandbags, and 55-gallon drums (**Figure 4.10**). If available, they can be earth-filled and used as obstacles for various purposes (i.e., block roads and entry points, establish standoff, reinforce perimeters, control vehicle traffic, etc.). In an austere environment, individuals are limited only by their imagination in how readily available fill material can be used in conjunction with prefabricated structures and materials to construct effective obstacles. In addition, some of the same structures and materials that can be used to create obstacles can also be stacked and used as revetments, which will be covered in **Chapter 5**.

Figure 4.10. Earth-Filled Obstacles.



4.4.6. **Urban Rubble.** In the urban environment, large chunks of concrete, junked vehicles, and damaged equipment are a few examples of items that can be used as obstacles (**Figure 4.11**). Built-up areas can naturally restrict movement due to the amount of existing structures. These areas are normally not used to beddown personnel deployed to overseas locations. However, they may exist nearby and could be used as a staging area for enemy forces to attack the base. Security personnel may use these areas as part of the base defense. The use of urban rubble as obstacles can be further enhanced by cratering streets, demolishing walls, and overturning or derailing heavy vehicles or railroad cars. Roadblocks can be built from rubble or construction materials. Barbed wire can be used to surround urban rubble for increased effectiveness as obstacles. In this environment, personnel are only limited by their imagination.

Figure 4.11. Urban Rubble.



4.4.7. **Concertina Wire Roadblocks.** When laid in depth about 11 rows deep across a roadway, strung concertina wire can be used as a roadblock (**Figure 4.12**). It is more effective when supported by pickets, and can also be used in conjunction with steel hedgehogs. The materials needed to construct this obstacle include 11 rolls of concertina wire, one roll of barbed wire, 30 long pickets, and 22 short pickets. This material is enough to construct a concertina wire obstacle approximately 33 feet in depth along the roadway. For engineers experienced in laying concertina wire, this obstacle can be constructed in approximately one hour. **Table 4.2** contains installation procedures for the concertina wire roadblock.

Figure 4.12. Concertina Wire Roadblock.

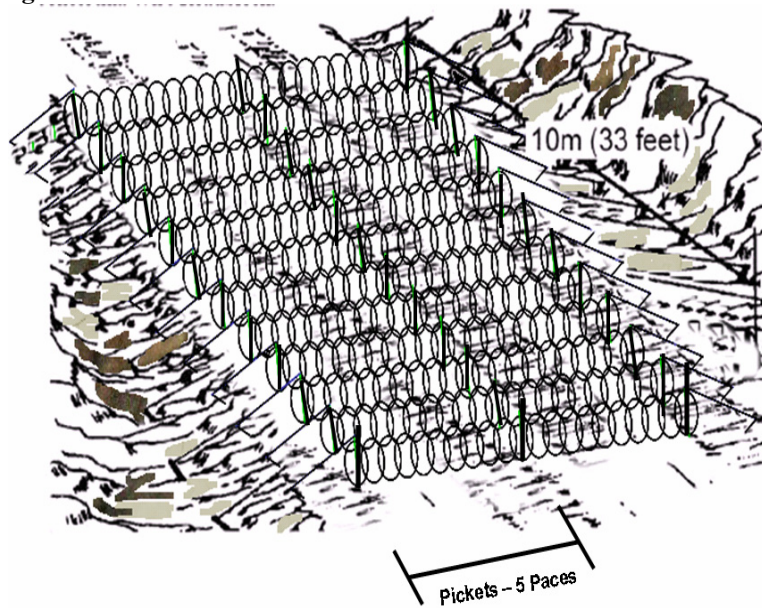


Table 4.2. Installation Procedures – Concertina Wire Roadblock.

1 <input type="checkbox"/>	Determine location and lay out 11 rows of three of the long pickets spaced five paces apart, leaving one pace between
2 <input type="checkbox"/>	Lay out an anchor picket at the end of each row, placing the anchor pickets two paces from the long pickets
3 <input type="checkbox"/>	Install pickets, ensuring lower notches of pickets are 4 inches aboveground, and concave side of U-shaped picket
4 <input type="checkbox"/>	Position three rolls of concertina wire at the 3 rd , 6 th , and 9 th rows, and two rows of wire at the 11 th row.
5 <input type="checkbox"/>	Drive the long pickets for the 1 st row and all but the centerline picket for the 2 nd row
6 <input type="checkbox"/>	Drive the short pickets for the 1 st row and tie the barbed wire to the short picket
7 <input type="checkbox"/>	Lift and place the wire in the 1 st row, then anchor it to ground with five staples
8 <input type="checkbox"/>	Run the barbed wire across the top of the 1 st row and tie it to the other short picket
9 <input type="checkbox"/>	Once the 1 st row is completed, drive in the centerline picket for the 2 nd row
10 <input type="checkbox"/>	Drive in all pickets for the 3 rd row except the centerline picket
11 <input type="checkbox"/>	Lift and place the wire in the 2 nd row, then anchor it to ground with five staples
12 <input type="checkbox"/>	Tie barbed wire to one short picket in the 2 nd row, run it across the top of the 2 nd row; tie it to the other short picket
13 <input type="checkbox"/>	Repeat the procedures for rows 3 through 11
14 <input type="checkbox"/>	Place a log between the 5 th and 6 th row

4.4.8. **Concertina Wire Fence.** Concertina wire is commonly used as an obstacle in the expeditionary environment. A triple-strand concertina wire fence can be a very effective obstacle. This type of fence uses three rolls of stacked concertina wire. One roll is stacked on top of two rolls running parallel to each other, forming a pyramid. This obstacle can delay an intrusion long enough to allow security forces to engage the enemy. **Table 4.3** describes installation procedures for triple-strand concertina wire fence.

Table 4.3. Installation Procedures – Triple-Strand Concertina Wire.

1 <input type="checkbox"/>	Lay out front row of long pickets at 5-pace intervals; place short pickets 2 paces from each end (Figure 4.13)
2 <input type="checkbox"/>	Place rear row of long pickets 1 meter behind front row and staggered; place short pickets 2 paces from each end
3 <input type="checkbox"/>	Install pickets with the lower notch 4 inches aboveground; ensure the concave side of U-shaped picket faces enemy
4 <input type="checkbox"/>	Position a roll of concertina wire at the 3 rd picket in the front row, and every 4 th picket thereafter
5 <input type="checkbox"/>	Lift each roll of concertina wire on the front row and drop it over the long pickets; join ends as illustrated in Figure 4.14
6 <input type="checkbox"/>	Fasten the bottom of the concertina wire to the ground by driving a staple over each pair of end hoops, one over the bottom of a coil at each long picket, and one at the 1/2 and 1/4 points of the 3.8-meter (12.5-foot) picket spacing
7 <input type="checkbox"/>	Stretch a barbed wire strand along the top of each front row and fasten it to the tops of the long pickets, using the top eye tie for screw pickets. These wires are stretched as tightly as possible.
8 <input type="checkbox"/>	Repeat the installation process for the back row, then install the top row and attach it to the back row

Figure 4.13. Picket Spacing.

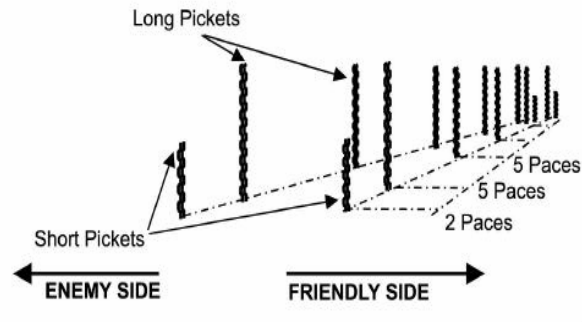
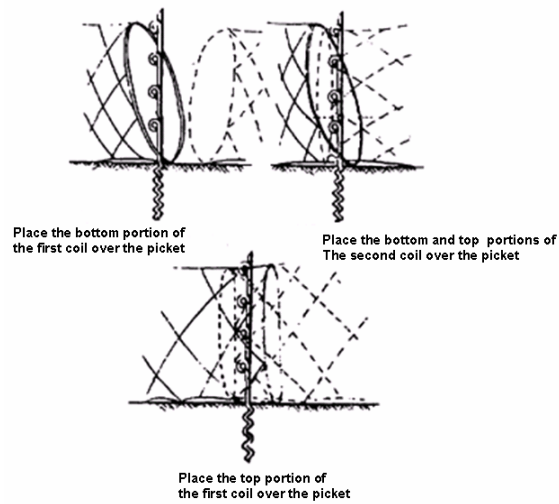


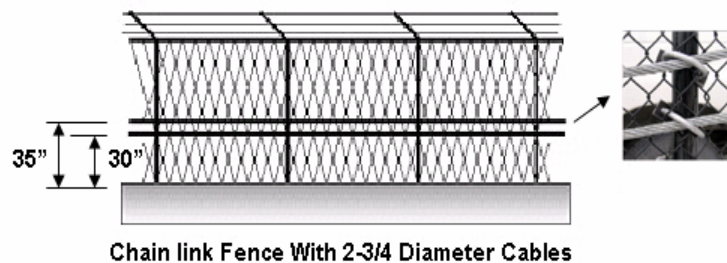
Figure 4.14. Joining Rolls of Concertina Wire.



4.5. Prefabricated Obstacles. The remainder of this chapter focuses on those obstacles that are usually prefabricated and moved into place as needed, and those obstacles that are not usually considered expedient due to the time and materials needed for construction.

4.5.1. Chain Link Fencing. Chain link fencing can be used to form a continuous obstacle around a site. Although they are considered obstacles to pedestrian traffic, fences are not very effective unless reinforced using cables or other methods to prevent them from being easily breached. This can be accomplished with cable at least $\frac{3}{4}$ -inch in diameter. The cable is strung at 30 inches and 35 inches above the ground (**Figure 4.15**). Fences can also be used in conjunction with other security measures such as berms, earth-filled containers, surveillance cameras, motion detectors, etc. Once constructed, they should be inspected frequently to detect evidence of breaches and to ensure any maintenance needed is identified. For additional details on designing security fencing, reference MIL-HDBK-1013/10, *Design Guidelines for Security Fencing, Gates, Barriers, and Guard Facilities* (will be republished as UFC 4-022-03). If it is determined that fence construction should be accomplished via local contract, the specifications in UFGS-32 31 00.00 10, UFGS-32 31 13.00 20, and UFGS-32 31 13.00 40 can be used in developing the contract Performance Work Statement (PWS). This document, along with any other UFGS documents, can be downloaded from the Whole Building Design Guide (WBDG) website at <http://www.wbdg.org>.

Figure 4.15. Fence Reinforced With Cable.



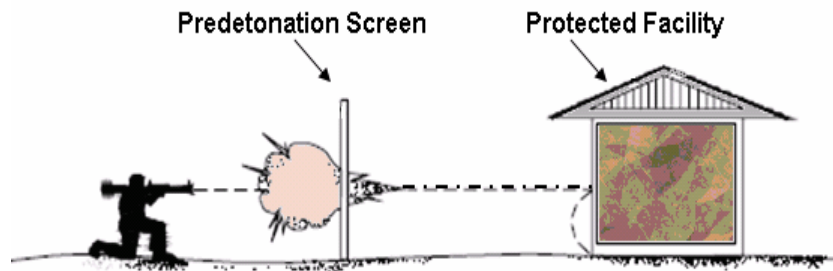
4.5.2. Obscuration Screens. Perimeter obscuration screens are used to block direct lines of sight to sensitive areas or facilities from outside the perimeter of a site in an effort to reduce targeting opportunities from direct-fire weapons. This can be done in various ways using trees, dense vegetation, chain link fences with slats, wooden fences, camouflage netting, etc. Obscuration screens are not usually designed or constructed to provide protection against direct fire. If installed around facilities, place obscuration screens on the side(s) facing the site's perimeter to reduce exposure. Obscuration screens can also be placed on perimeter fences to block lines of sight into the camp area (**Figure 4.16**). When using obscuration screens on fences, make sure personnel inside the site or facility are still able to see outside and observe any suspicious activities.

Figure 4.16. Obscuration Screen on Perimeter Fence.



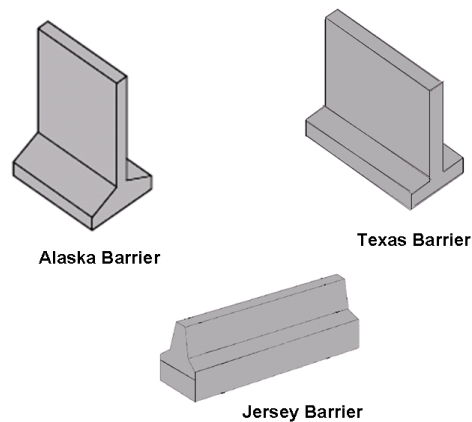
4.5.3. Predetonation Screens. Predetonation screens are used to detonate antitank weapons and dissipate the effects between the area where the screen is constructed and the weapons' primary target (**Figure 4.17**). The screen can be constructed of wood, solid fencing material, etc. It is usually constructed between 10 to 40 feet from the structures it is intended to protect. For additional information on constructing and siting predetonation screens, refer to UFC 4-020-03FA. A predetonation screen may have several effects. Hopefully, it will damage the fuze on the weapon, causing it to dud. The structure being protected must still be capable of defeating the kinetic energy of the fired round. The primary purpose is to detonate an antitank rocket when it strikes the screen. In this case, the combination of standoff distance and the construction of the protected facility must defeat the gas jet from the shaped charge. Antitank rounds emit a concentrated stream of molten metal upon detonation (known as shaped charge) capable of penetrating several inches of steel. The predetonation screen must cause the round to detonate far enough from the asset to mitigate the damage from the molten material and spent rocket engine.

Figure 4.17. Predetonation Screening.



4.5.4. Concrete Barriers. With the exception of the Jersey barrier, most concrete barriers currently being used throughout Southwest Asia are from 8 to 12 feet tall, 4 to 6 feet wide, weigh between 10,000 and 20,000 pounds, and are usually reinforced with steel (**Figure 4.18**). Tall concrete barriers, such as the Texas barrier and Alaska barrier, are being used for various reasons, including protection from the effects of blast and fragmentation. The effectiveness of these barriers depends on their thickness, height, and distance from the asset being protected. If a barrier breaks apart as a result of a detonation, the debris generated from the barrier itself becomes secondary fragmentation and can be quite lethal, offsetting efforts to reduce the effects of fragmentation. When planning to deploy these types of barriers throughout the site, the civil engineer planner must consider the heavy equipment (e.g., cranes, flat-bed trailers) that will be needed to transport and maneuver these structures into place. Once barriers are in place, earth-filled containers or soil berms can be used to reinforce them to prevent secondary fragmentation in the event the barrier breaks apart from the force of a detonation. Detail drawings of all types of concrete barriers can be downloaded from the AFCESA AT/FP Installation Engineering Community of Practice at: <https://wwwd.my.af.mil/afknprod/ASPs/CoP/OpenCoP.asp?Filter=OO-EN-CE-A7>.

Figure 4.18. Concrete Barriers.



4.5.5. Vehicle Barriers. Vehicle barriers are categorized as either active or passive. Active and passive barriers can be fixed or movable, depending on how they are made, operated, or used. Some commercial barriers are dual-classified when they meet the requirements for both categories (e.g., fixed-active, portable, passive). Fixed vehicle barriers are permanently installed and usually require heavy equipment to move or dismantle. Examples include hydraulically-operated rotation or retracting systems, pits, and concrete or steel barriers. Portable vehicle barriers are those barriers that can be easily relocated if needed. However, heavy equipment may be required in some cases to lift and transport these types of barriers. The following paragraphs briefly describe some of the types of vehicle barriers that can be used in the expeditionary environment. For details on selection and application of vehicle barriers, refer to UFC 4-022-02. In addition, a list of DOD-certified anti-ram vehicle barriers can be downloaded from the USACE PDC website at <https://pdc.usace.army.mil>. The list is updated periodically as different types of anti-ram vehicle devices are crash-tested.

4.5.5.1. Active Vehicle Barriers. Active barriers are those with moving parts that require some action, either by personnel, equipment, or both. These are mechanical devices used primarily to block access by vehicles that are a potential threat. A couple of examples of active vehicle barriers are shown in **Figure 4.19** and **Figure 4.20**. In addition to those illustrated, active barriers include retractable bollards, beams, and sliding gates. Most of these barriers will require civil engineer support for setup and installation. More permanent types of active barriers are usually purchased through supply channels, moved into place using heavy equipment, and installed in accordance with the manufacturer's instructions. For planning purposes, UFC 4-022-02 contains barrier performance ratings and cost data for different types of active barriers. It may also be possible to obtain contract support for on-site construction of active vehicle barriers. If this option is being considered, refer to UFGS 34 71 13.19, *Active Vehicle Barriers*, when constructing performance work statements. This document can be downloaded from the WBDG website at <http://www.wbdg.org/>.

Figure 4.19. Portable Lift Barrier.

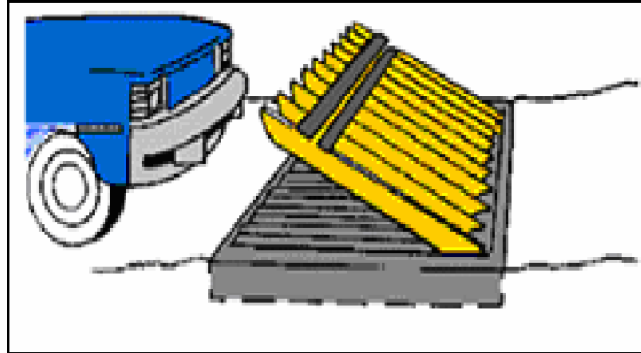
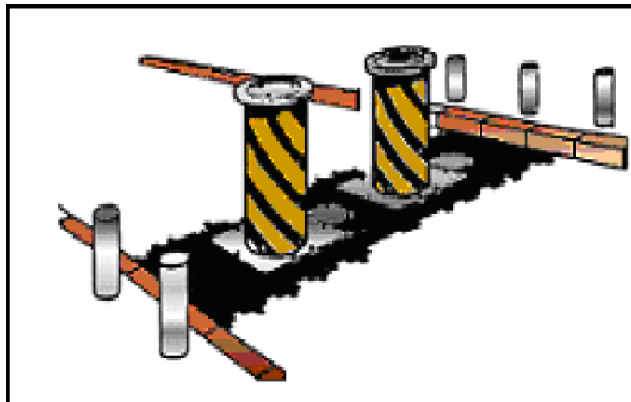


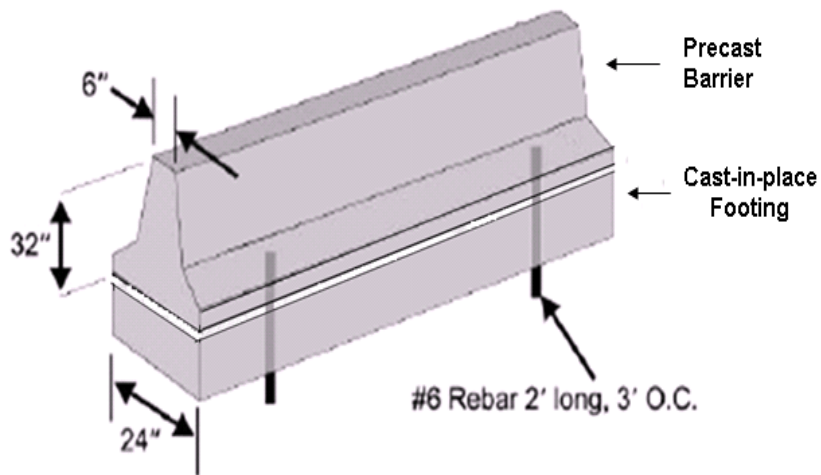
Figure 4.20. Retractable Bollards.



4.5.5.2. **Passive Vehicle Barriers.** Unlike active barriers, passive vehicle barriers have no moving parts. Their effectiveness relies upon their ability to absorb energy and transmit that energy into the foundation. The following paragraphs briefly describe some types of passive vehicle barriers.

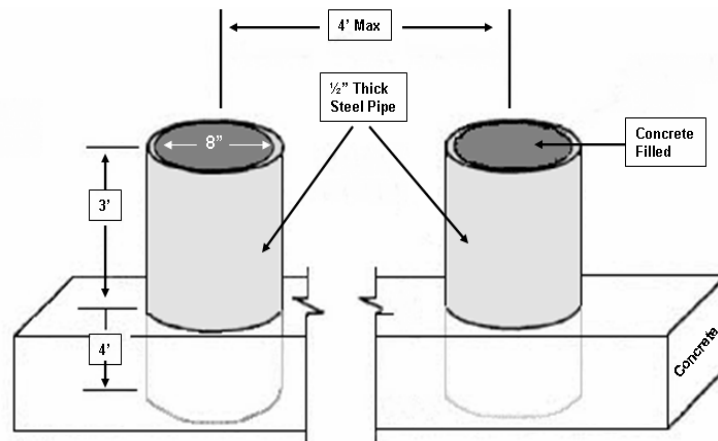
4.5.5.2.1. **Jersey Barriers.** Jersey barriers ([Figure 4.21](#)) are typically employed for countermobility around entry control points and approach avenues. They can be staggered on roads to create serpentine paths, forcing drivers to slow down to negotiate curves prior to reaching the entry point. They can also be used to establish site boundaries. To be an effective vehicle barriers, they must be anchored to the surface and/or cabled together (along straight paths) to provide added strength and resistance.

Figure 4.21. Jersey Barrier.



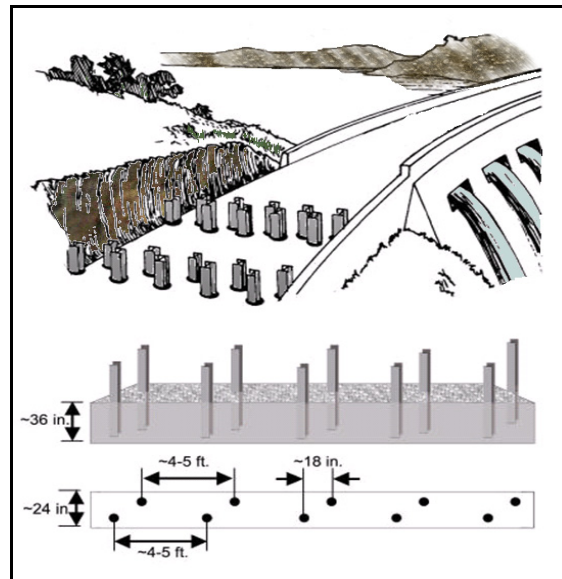
4.5.5.2.2. **Fixed Bollards.** Fixed bollards are excellent obstacles for anti-ram protection. In the field environments, these obstacles can be constructed of $\frac{1}{2}$ -inch thick steel pipe about 8 inches in diameter and 7 feet long. The pipes are filled with concrete and anchored into a 4-foot concrete footing so they project 3 feet above the ground (Figure 4.22). The pipes should be spaced no more than 4 feet apart. Fixed bollards can be placed inside or outside existing fences to channel vehicle traffic away from certain areas or prevent vehicular access into certain areas. When planning for fixed barriers such as these, several factors such as future site expansion and possible relocation of facilities and other structures should be taken into consideration. These types of activities may require fixed bollards to be excavated and reconstructed in other areas. Also, be careful not to place permanent barriers in areas where emergency response vehicles may need to gain access in the event of an attack or other emergency.

Figure 4.22. Fixed Bollards.



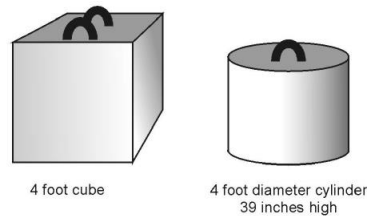
4.5.5.2.3. **Removable Posts.** Removable posts can be set in a prefabricated concrete base constructed under the road (**Figure 4.23**). Steel posts, such as heavy-walled, 6-inch diameter pipes or steel I-beams approximately 7 feet long, can be used. A 30-inch long steel pipe sleeve is constructed into the base and slightly recessed from the top. The inside diameter of the sleeve should be just large enough to accommodate the posts. The number of rows and spacing may depend upon the availability of time, materials, threat, and location. Pipes can be filled with concrete for additional strength. Stagger the sleeves as indicated, maintaining 4 to 5 feet between posts and 18 inches to the front and back of each row. Keep rows about 10 feet apart. Cover the sleeves when not in use to keep out debris. When required, remove the covers and drop the posts into place (heavy equipment may be needed). Lift handles can be welded to the posts for easy removal, and concertina wire can be strung throughout the rows to complicate removal by enemy forces.

Figure 4.23. Removable Posts.



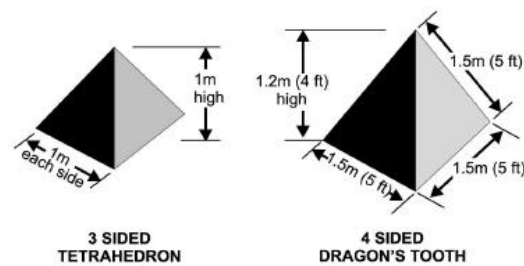
4.5.5.2.4. **Concrete Cubes and Cylinders.** Concrete cubes and cylinders can be effective obstacles. Cubes and cylinders of concrete (Figure 4.24) can be cast in place or precast and moved into place. Place the obstacles in irregular patterns to prevent wheeled and tracked vehicles from moving between them or pushing the obstacles out of position. They can be used between buildings or on top of elevated roadways to block traffic. To be effective vehicle barriers, they must be cabled together.

Figure 4.24. Typical Concrete Cube and Cylinder.



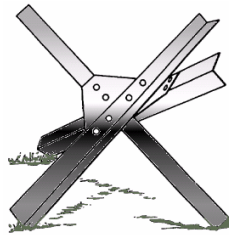
4.5.5.2.5. **Concrete Tetrahedrons and Dragon's Tooth.** Concrete tetrahedrons are pyramids with a triangular base, while dragon's teeth are concrete pyramids with a square base (Figure 4.25). These obstacles are effective in stopping vehicles where access is restricted (i.e., roadways between buildings). Dragon's teeth are employed in multiple rows across an avenue of approach. Space the dragon's teeth about 4 to 5 feet between teeth and rows across the avenue of approach; rows can be aligned or staggered. They must be cabled together to be effective vehicle barriers.

Figure 4.25. Tetrahedrons and Dragon's Teeth.



4.5.5.2.6. **Steel Hedgehogs.** Hedgehogs are made using three pieces of angle iron 4 inches by 4 inches and approximately 4 feet long. The pieces are welded to a 4-inch steel plate ([Figure 4.26](#)). They can weigh up to 160 pounds. They are designed to rotate under vehicles and puncture or overturn them. They perform well in areas with high vegetation where they can be concealed. Exposed parts can be painted to blend with the terrain. Steel hedgehogs must be cabled together to be effective vehicle barriers.

Figure 4.26. Steel Hedgehog.



Chapter 5

REVETMENTS

5.1. Overview. Revetments are generally defined as raised walls or structures designed to provide protection against bombs, rockets, grenades, small arms fire, and the effects of blast and fragmentation. Revetments can be as simple as a wall of sandbags or as elaborate as major construction projects involving permanent, hardened revetments and aircraft shelters (**Figure 5.1**). Revetments of sufficient height can be used to provide full sidewall protection around open stores of critical equipment and material assets. Revetments can also function as obstacles to vehicles and other forms of possible intrusion. In the expeditionary environment, revetments are commonly composed of a soil berm and some type of structural material used as a retaining wall to hold back and stabilize the mass of earth. This type of revetment can be very effective against blast and fragmentation effects. This chapter covers the different types of revetments that can be used for a variety of purposes in the expeditionary environment.

Figure 5.1. Various Types of Revetments.

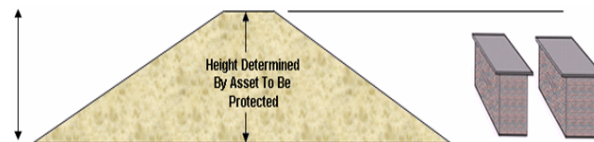


5.2. Berms. Time available to conduct comprehensive planning during initial stages of deployments can be very limited. Logistical support needed to immediately implement force protection measures may also be difficult at the height of a military campaign. Initially, earthen berms may be the engineer's best option for protecting military personnel and mission-critical assets. Properly sited, constructed, and maintained, berms can mitigate blast and fragmentation effects from near-miss explosions caused by mortars, rockets, or artillery shells. They are particularly effective against explosions that produce blast effects moving at high velocities and generating low-angle fragments along the ground's surface. In austere environments, berms can be used to define boundaries, act as barriers, reduce noise, and obstruct lines of sight. The height of force protection berms can be anywhere from 6 to 12 feet. Required heights are usually based on the height of equipment or structures to be protected and known threats within the area or region. While berms and other types of revetments, such as those constructed from sandbags or timber, provide similar stopping ability for high-explosive detonations and projectiles, earth berms provide better protection against multiple or repeated attacks. When an earth berm is hit, its mass tends to engulf the round, and ejected matter falls back onto the berm. Berms can be freestanding, supported by different methods of revetting, or built directly upon structures for protection. They can also be used to reinforce other protective measures such as reinforced fences, concrete structures, sandbags, or earth-filled containers structures. Regardless of the purpose or type of berm being constructed, much soil will be needed. Berm construction also requires heavy equipment (i.e., dump truck, backhoe, bulldozer, roller compactor, etc.) to move large masses of soil around and skilled equipment operators. Engineers must take these factors into consideration while planning for force protection. It is important to note that earth berms, because of their shapes (i.e., low-sloped faces, limited heights, etc.), have limited effectiveness in protecting certain weapon systems and critical aircraft support operations; therefore, additional measures may need to be employed. The next few paragraphs describe the use of berms in the expeditionary environment. Additional information on different types of berms can be downloaded from [TCMS](#).

5.2.1. Free-Standing Berms. When designing free-standing berms, key elements to consider are height, thickness, and slope. Also keep in mind the need to use natural vegetation, geotextile fabric, and/or a drainage system to prevent erosion. If camouflage and concealment are important, consider adding more vegetation and varying the berm's width and height along the perimeter to reduce its visual signature. The next few paragraphs cover basic considerations for designing and constructing free-standing berms.

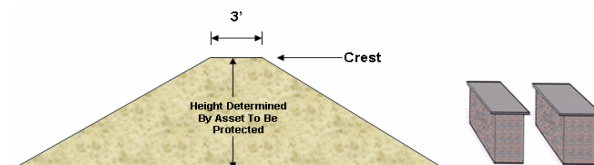
5.2.1.1. Berm Height. Berm heights ([Figure 5.2](#)) are usually determined by the height of the asset(s) to be protected. If the asset to be protected is 6 feet tall, the berm will need to be at least that height for adequate protection.

Figure 5.2. Berm Height.



5.2.1.2. Berm Thickness. Required thickness is usually determined by the desired level of protection for the asset(s) and any known threats. Security and Intelligence personnel will be involved in making this determination. A berm's thickness is measured at its crest ([Figure 5.3](#)), which is where the slope of the berm levels off. A small slope is still maintained at the crest to allow for drainage and prevent ponding. If the berm's required thickness is determined to be 36 inches, the berm must be 36 inches thick at its crest. [Attachment 2](#) contains information on various thicknesses of materials needed to protect against certain threats. For practical purposes (e.g., maintenance), the crest of a free-standing berm is usually between 2 and 3 feet.

Figure 5.3. Berm Thickness.



5.2.1.3. Berm Slope. The slope of a free-standing berm is approximately equal to the soil's internal angle of friction or angle of repose (**Figure 5.4**). The angle of repose is the steepest grade at which the type of soil used will remain in place without reinforcement. If granular or loose soils are used for construction, it will be difficult to obtain a steep slope since the angle of repose places limits on the capability to form a steep slope without reinforcement. If more cohesive soils (e.g., soils containing clay) are used, it is possible to form a steeper slope because the soil will remain in place at steeper angles than it would with loose or granular soils. A berm's slope is described as its vertical to horizontal distance (V:H) as measured from the center of the berm. For force protection berms, the slope is normally between 1:1 and 1:2. Let's suppose the height (vertical length) of a berm with a 1:1 slope needs to be 10 feet tall, with a 3-foot crest. Without considering the crest size initially, the horizontal length of the berm from the center would also be 10 feet (1:1 slope). However, with a 3 foot crest, the horizontal length of the berm (from its center) will be equal to the height of the berm plus 1 foot and 6 inches, or 11 feet and 6 inches. The additional length accounts for $\frac{1}{2}$ the length of the berm's crest (3 feet), which is a relatively horizontal surface. Using the same example, we can determine that the total horizontal length of an 11-foot berm with a 1:1 slope and 3 foot crest would be approximately 23 feet (11 feet and 6 inches + 11 feet and 6 inches). **Figure 5.5** illustrates the difference between berms with slopes between 1:1 and 1:2. Note that the slope gets less steep as the angle of repose decreases. If berm slopes need to be steeper than is possible with the type of soil being used, reinforcement will be required. Some concepts of berm reinforcement are covered in the next few paragraphs.

Figure 5.4. Berm Slope.

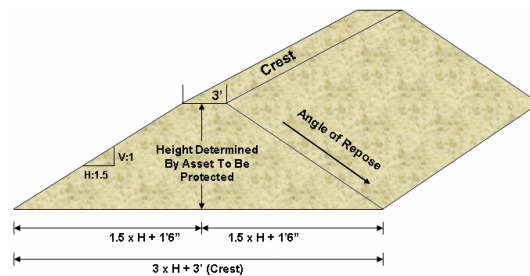
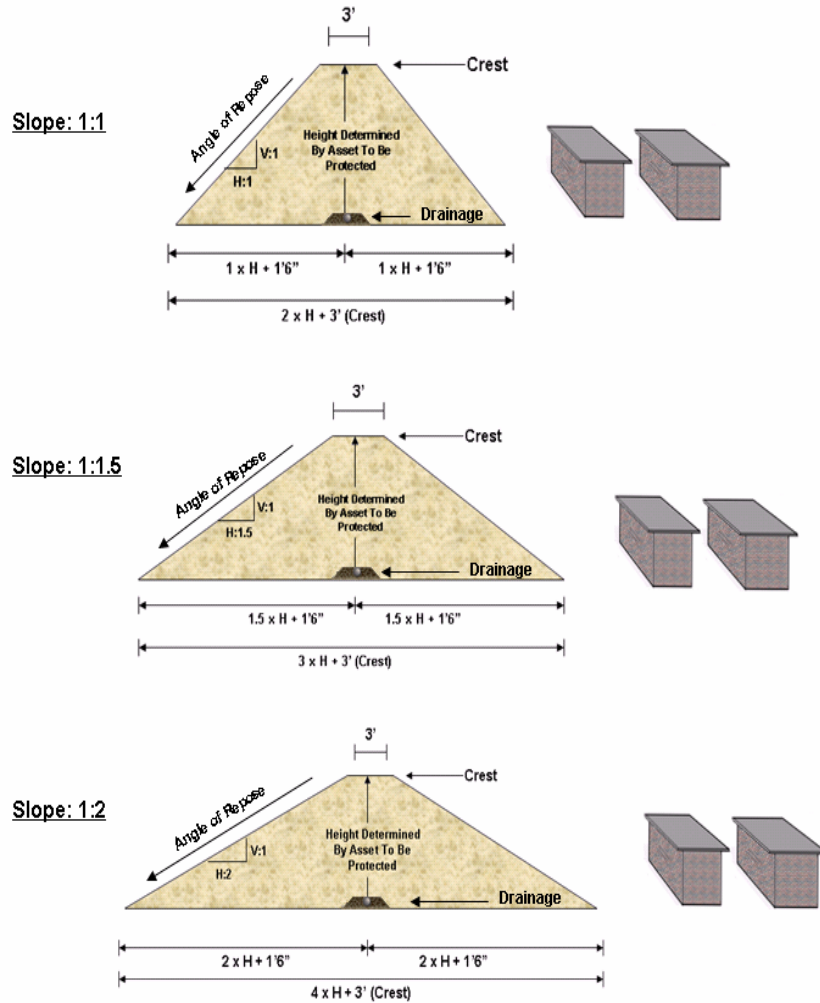


Figure 5.5. Illustration of Berms With Varying Slopes.



5.2.2. Structurally-Supported Berms. Berms can be supported by bracing or other means of structural support which allows them to be constructed much closer to critical assets than free-standing berms (**Figure 5.6**). Precast concrete retaining walls are an excellent means of structural support for berms. If precast concrete obstacles are not available, expedient retaining walls can be built using plywood, corrugated metal, landing mats, or whatever sturdy material might be available with enough strength to provide the needed support. Bracing material can be tied to deadman supports that are either exposed on the face of the berm or buried underneath (**Figure 5.7**). When constructing these types of berms, remember to allow enough room between the structure and the face of the berm to allow personnel space to maneuver heavy equipment or other support needed to perform berm maintenance.

Figure 5.6. Structurally-Supported Berm.

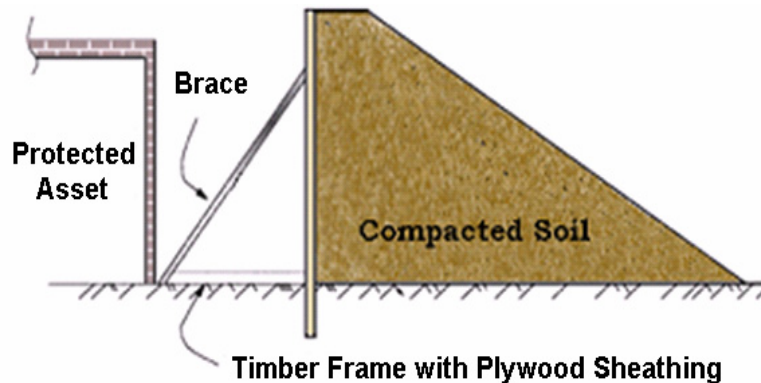
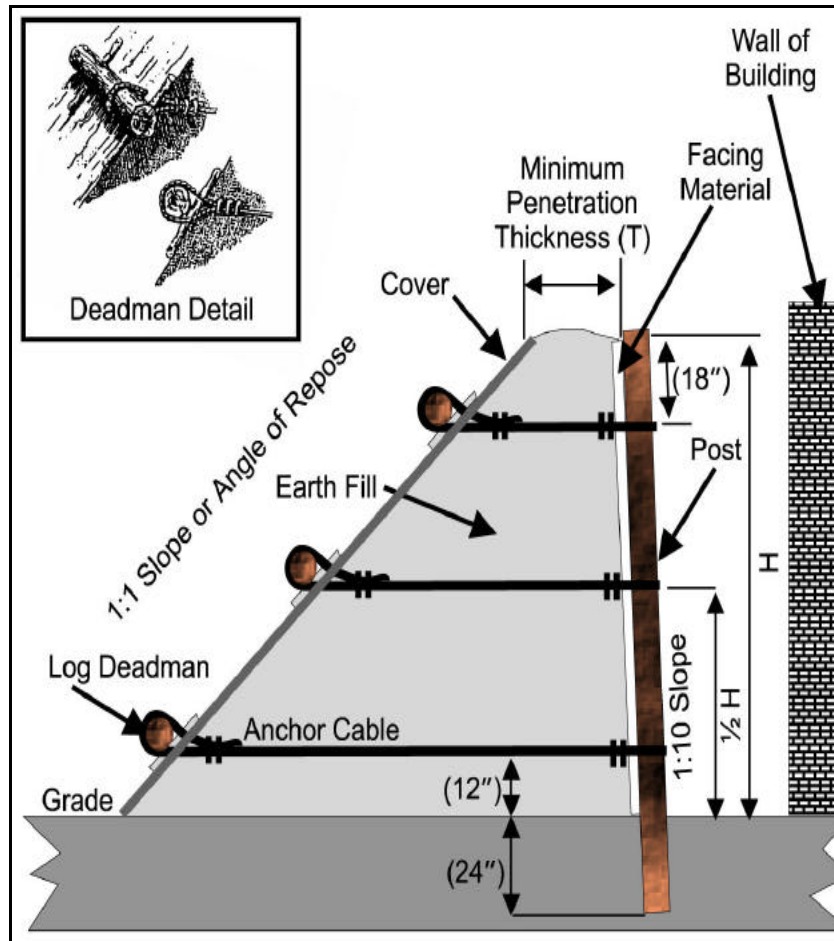


Figure 5.7. Structural Support for Berms.



5.2.2.1. **Reinforcing Berms.** Berms can be used to provide additional strength to other barriers such as concrete structures. If an existing above-ground concrete wall can resist airblast loads but the wall thickness is not sufficient to prevent concrete spall from airblast and fragments, a soil berm placed against the wall is almost always the most economical way to prevent spall (**Figure 5.8**). Sandbags can be used to reinforce the berm's face, especially if the berm is constructed of granular materials. Berms can also be built directly upon the structure they are intended to protect (**Figure 5.9**). In some cases (dictated by the threat), berms can be built upon a structure and continued over the top of the structure. Engineers with experience in structural analyses must make the determination on whether any structure can support additional loading from berming.

Figure 5.8. Berm Supported by Revetments.

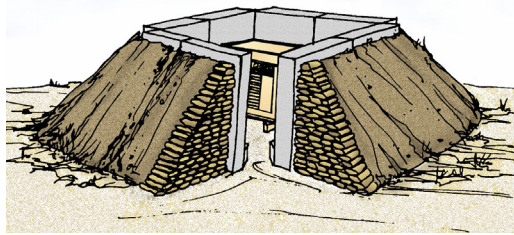
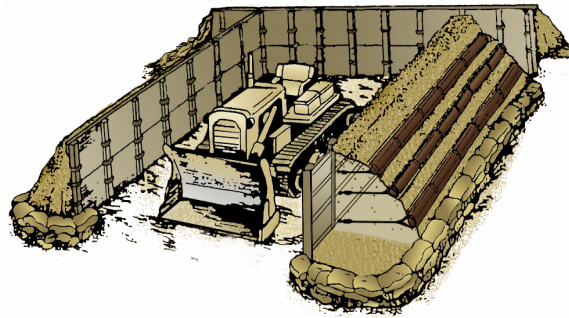


Figure 5.9. Berm Supported by a Facility.



5.2.2.2. Berms and Retaining Walls. If precast concrete revetments are not available for expediency, berms can be constructed against retaining walls if the proper materials are available. Building a berm against a retaining wall allows the berm to be located closer to the asset (**Figure 5.10**). Close placement provides a greater degree of protection from the effects of blast and fragmentation. Retaining walls should be no more than 11 feet high. One-sided retaining walls may also be built with 6- by 12-foot posts, 4- by 4-foot horizontal runners, and a sheathing surface of at least 1½ inches of plywood, heavier gauge (16 gauge or better) corrugated metal, or landing mats. Posts should be set at least 4 feet into the ground and no more than 4 feet apart. On the berm side of the posts, starting at ground level, nail horizontal runners to the posts at no more than 2 feet apart for each runner. Fill in between the 4- by 4-foot runners by nailing short sections of 4- by 4-foot pieces to the posts between runners. Fasten the plywood or metal sheathing to the 4 x 4s. There are two ways to anchor the retaining walls to each post. The more protected way is to anchor each post approximately two-thirds the height of the berm to deadman anchors that will be located under the berm material. Use at least 3/8-inch guy cable run on a 3:1 slope (vertical to horizontal) down to the deadman anchor. The alternative method is to anchor each post to three individual deadman anchors placed along the face of the berm. While this can help stabilize the berm, it exposes the anchors to more damage from blast.

Figure 5.10. Berms Supported by Retaining Walls.



5.3. Sandbag Revetments. Walls can be built from sandbags in much the same way as bricks are used to construct walls. Keep in mind, however, that sandbag revetments require a lot of time and labor. In addition, sandbags tend to deteriorate in extreme weather environments. While planning, purchasing, or ordering sandbags, keep in mind that all sandbags are not made of the same material and are therefore not of the same quality. For limited use, sandbags of lesser quality can be used. However, for prolonged use under extreme weather conditions, a higher quality sandbag may be needed. The following paragraph covers the different types of sandbags that can be used and procedures for building sandbag revetments.

5.3.1. Types of Sandbags. Sandbags most commonly used during contingencies are made from cotton, polypropylene, or acrylic materials. The polypropylene sandbags tend to last longer than cotton sandbags. Acrylic sandbags (quickly replacing cotton and polypropylene bags) are rot and weather resistant. The US Army Engineer Research and Development Center (ERDC) conducted a study of sandbag materials' ultraviolet (UV) resistance to determine which products provide optimal service life considering unique exposure conditions in areas such as Southwest Asia (SWA). The study focused on identifying what material maintained tensile strength (property associated with the material's integrity) under prolonged exposure to UV radiation. The study concluded cotton duck material performs best under these conditions, followed by acrylic materials, which also performed well. **Table 5.1** contains national stock numbers for sandbags approved for use by DOD and available through regional defense supply centers.

Table 5.1. Sandbag National Stock Numbers.

National Stock Number	Description
8105-00-142-9345	Polypropylene Sandbag
8105-00-782-2709	Cotton Duck Sandbag
8105-00-935-7101	Acrylic Sandbag
8105-00-285-4744	Burlap Sandbag

5.3.2. **Siting Sandbag Revetments.** Sandbag revetments may not provide effective protection from blast overpressure if not properly sited. These types of revetments may be effective against fragmentation effects; however, unless the shielding can be located very close to the asset as shown in [Figure 5.11](#), blast overpressure may still impact the asset. If revetments are sited close enough to the protected asset, they may be able to deflect the blast wave over the asset to prevent damage. If a structure can withstand the additional side load, sandbag revetments can also be built with a straight face against the wall of the structure ([Figure 5.12](#)).

Figure 5.11. Sandbag Revetment Close to Protected Asset.

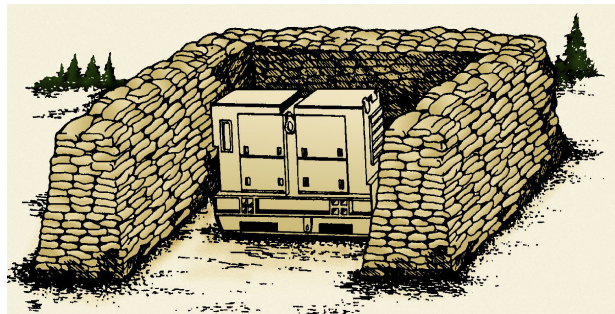
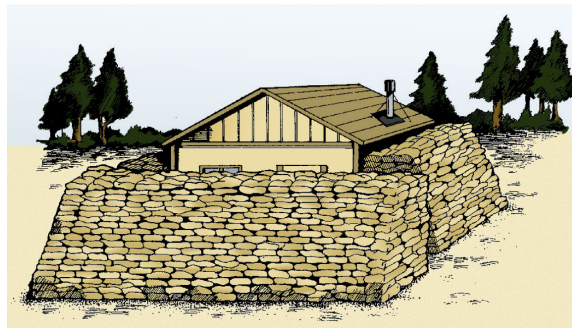
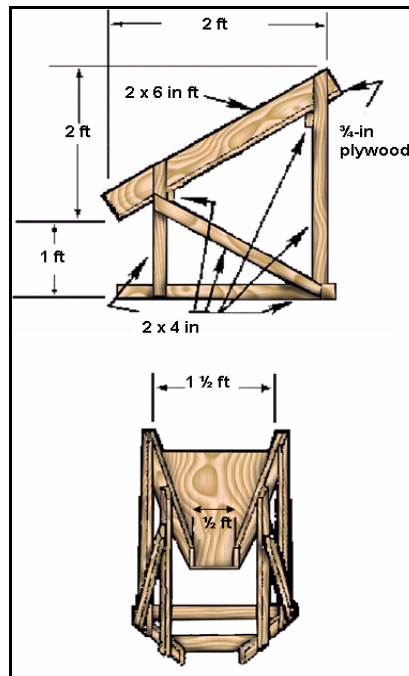


Figure 5.12. Sandbag Revetment Built Against a Structure.



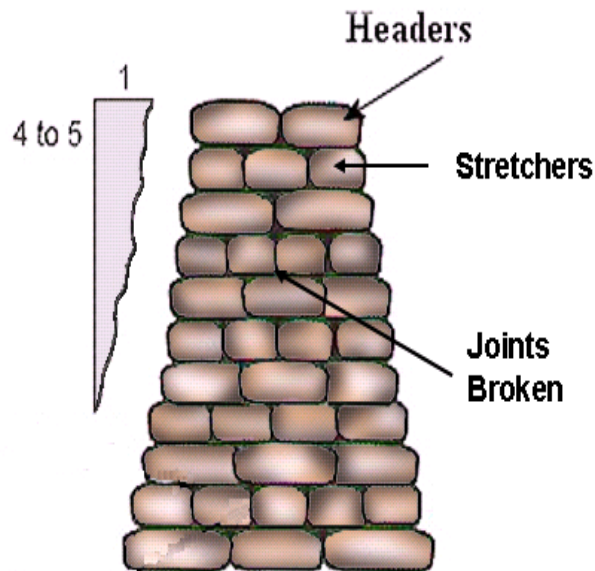
5.3.3. Sandbag Revetment Construction Details. After properly siting the location for sandbag revetments, begin by filling the bags approximately 3/4 full with soil or a soil-cement mixture. Overfilling the sandbags will prevent them from being flattened or shaped. To fill in voids between bags, fill bags with less soil. The useful life of sandbags can be prolonged by filling them with a mixture of dry earth and cement, normally in the ratio of 1 part cement to 10 parts dry earth. The cement sets as the bags take on moisture. A ratio of 1:6 should be used for a sand-gravel mixture. To expedite the sandbag filling process, an expedient sandbag filler such as that illustrated in [Figure 5.13](#), can be constructed if materials are available. Prefabricated sandbag fillers can also be purchased commercially (check with the servicing logistics function).

Figure 5.13. Expedient Sandbag Filler.



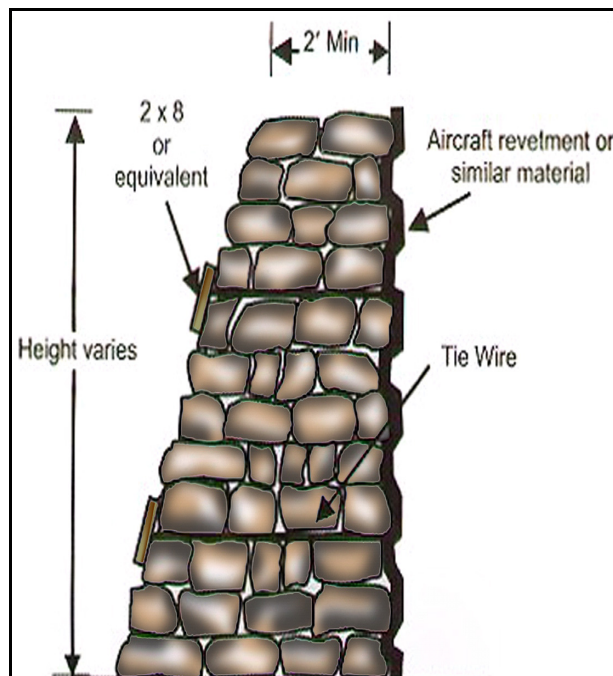
5.3.3.1. **Free-Standing Sandbag Revetment.** For a free-standing revetment, the sandbags should be sloped between 4:1 and 5:1 (vertical to horizontal) for any structure over 2 feet ([Figure 5.14](#)). Construct the bottom row of the revetment with sandbags placed as headers; then, alternate rows of headers and stretchers as indicated, staggering the joints between layers of sandbags. Each sandbag should be pounded with a flat object, such as a 2- by 4-inch board, to make the wall more stable. Stretchers should be placed with the sewn seams facing towards the reveted face, while headers are placed with the tied ends facing towards the reveted face. Ensure the top row of the revetment consist of headers. Before constructing sandbag revetments, determine if the base of the structure will need to be reinforced.

Figure 5.14. Sandbag Revetments – Layout and Construction.



5.3.3.2. **Partially-Braced Sandbag Structure.** Additional strength and stability can be provided to a sandbagged revetment by creating a partially-braced structure. Use landing mats, corrugated metal sheets, reinforced plywood, or other structural facing material on the vertical surface of the revetment and tie it to the sloped face for support (**Figure 5.15**).

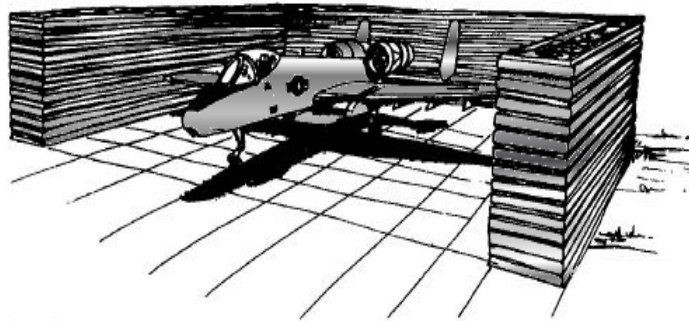
Figure 5.15. Sandbags Reinforcing Existing Revetments.



5.4. Metal Revetments. Metal bin revetments are designed to provide shelter or protection from low-angle, high-velocity fragments, shrapnel, and improvised explosive devices. They can also be used as anti-ram vehicle barriers. These types of revetments are made from some type of roll-formed metal, typically 16-gauge or 18-gauge steel.

5.4.1. B-1 Revetment. The B-1 revetment comes in a kit that provides a 16-foot high, 82-inch wide, and 252-foot long steel bin revetment (**Figure 5.16**). Due to the large concentrated mass of fill material required for this revetment, it must be constructed on a stabilized ground surface or pavement. The cell sections of the revetment are assembled in place or can be assembled on the ground and lifted into place with the use of a crane. When filling, use a porous material or a 1/2- to 3/4-inch gravel layer at the bottom to allow for drainage, an impervious sheeting material along the sides to contain soil material, and a waterproof cap to prevent fill saturation or FOD hazards. For details on constructing B-1 revetments, refer to procedures outlined in TO 35E4-170-2, *Aircraft Revetment Kit, Type B-1*.

Figure 5.16. B-1 Revetment.



5.4.2. Corrugated Galvanized Steel Revetments. The US Army ERDC developed metal revetments as an alternative to soil-filled geotextile revetments to address longevity issues related to severe environmental conditions (Figure 5.17). The design and technology are based on the B-1 revetment, weapons threats in SWA, and the reduced footprint needed for logistical requirements. Several kits were developed and are available through the Defense Supply Centers. Table 5.2 contains specifications and ordering information for these revetments. The overall pallet size for each kit is 37 inches wide, 100 inches long, and 19 inches high. For additional information, contact the servicing logistics function.

Figure 5.17. Corrugated Galvanized Steel Revetments.

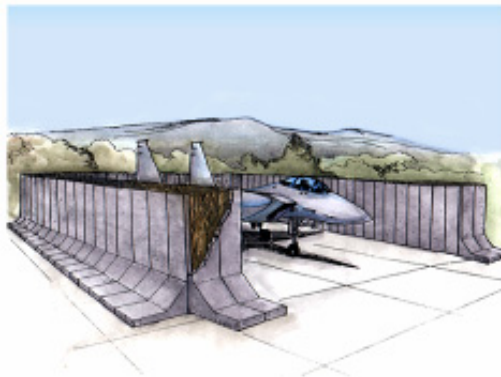


Table 5.2. Specifications and Ordering Information.

Type	NSN	Dimensions	Weight
MR-1	5450-01-535-7952	4' x 8' x 64'	4,535 lbs
MR-2	5450-01-535-7955	2' x 6' x 104'	4,329 lbs
MR-3	5450-01-537-7061	4' x 10' x 48'	4,401 lbs

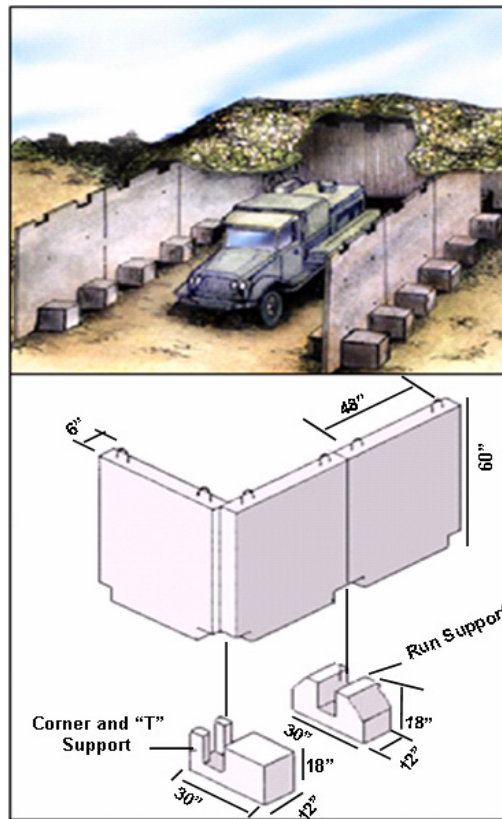
5.5. Precast Concrete Revetments. The use of precast concrete revetments (also referred to as concrete retaining walls) is an effective expedient method for protecting critical assets (**Figure 5.18**). They can be used in areas that require protection from fragmentation, airblast from near-miss general-purpose bombs, and high explosive artillery shells, rockets, mortars, and small arms. If used without berming, they provide good protection against a first strike, but limited protection from repeated or multiple attacks due to susceptibility to fragment damage and spalling. During repeated attacks, weakened or displaced slabs can break apart and become secondary fragmentation, posing yet another threat. The edges of most revetments do not have overlapping surfaces at the corners. The corners may require additional reinforcement (e.g., sandbags). If concrete revetments can be acquired locally, ensure the material used to construct these revetments meets military standards of construction. Also, be aware that equipment (i.e., flatbed trailer, forklift, crane, etc.) will be needed to move and place these revetments.

Figure 5.18. Precast Concrete Revetment.



5.6. Precast Concrete Wall. The portable precast concrete wall consists of a wall section with two notches that fit into two separate, notched footings of precast concrete (**Figure 5.19**). This type of revetment can be from 5 to 15 feet high, 6 feet wide, and 6 inches thick. The freestanding units can be butted together side-by-side and at 90-degree corners; they can also be enhanced with berms. Additional details on constructing and erecting precast concrete wall revetments can be downloaded from [TCMS](#).

Figure 5.19. Precast Concrete Wall.



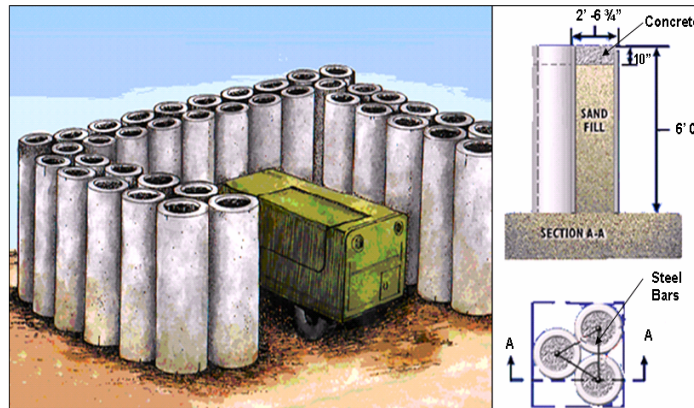
5.7. Soil-Cement Revetments. Soil-cement revetments provide greater protection from fragmentation and require less surface area than earthen berms ([Figure 5.20](#)). The walls of these revetments can be constructed with a 10:1 vertical-to-horizontal slope with a crest at least two feet thick. However, be aware that formwork and proper mixing equipment are required for construction. Depending on the wall's height, the foundation may require a higher bearing capacity than a soil berm and may have to be improved with a mixture of cement. In addition, walls with significant heights may need to be built in several lifts. If possible, build the formwork strong enough to allow forming in one or two lifts. If lifts are used, consider using some form of doweling between the lifts. The amount of water needed to moisten the mixture and allow cement hydration and the ratio of cement-to-soil (by weight) will vary based on soil type. Generally, 1-part Portland cement to 10 parts soil is used for soil-cement construction.

Figure 5.20. Soil-Cement Revetment.



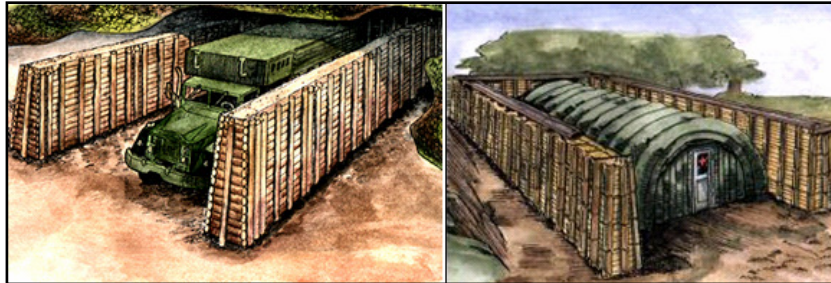
5.8. Concrete Culverts. Precast concrete culverts are constructed in various sizes, but are usually limited to 8-foot lengths for ease of handling. If the concrete culvert's outside diameter is at least 30 inches, it can be used for protective construction. Larger diameter culverts (up to 6 feet in diameter) can also be used. The culverts are stood up on end to stabilize the foundation and positioned closely together. If possible, obtain straight-sided culverts (without grooved ends) so they can be placed together vertically without any gaps between them. If the culverts have bell ends, place the larger bell ends down and fill in the gaps between rows with filled, smaller diameter PVC pipe or concrete culverts. Use at least two rows of culverts, and stagger the joints as indicated in [Figure 5.21](#). If available, drive steel dowels or pipes into the ground at the center of each pipe to stabilize them. Fill the culverts with dry sand or soil and cap the tops with at least 10 inches of concrete and a short length of exposed dowel or pipe. Tie the dowels together by welding reinforcing bars to the dowels on each row and between the opposite two adjoining culverts. Do not stack culverts on top of each other. Be aware that concrete culverts come in various strengths to resist traffic loads. Culverts with little traffic loading capacity are usually constructed with lower quality concrete and less reinforcing, making them unsuitable for use.

Figure 5.21. Concrete Culvert Soil Bin.



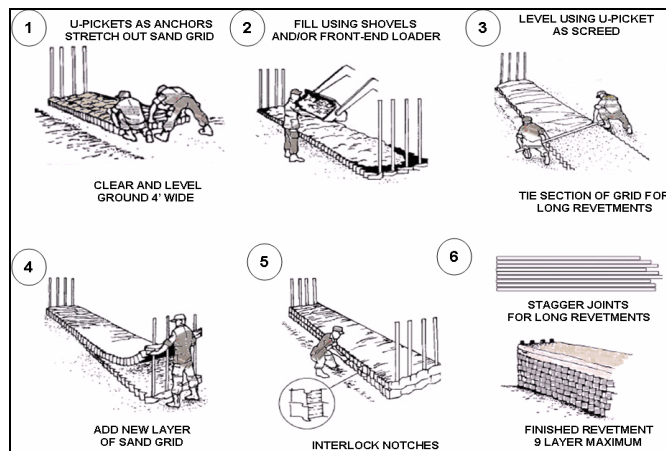
5.9. Timber and Lumber Revetments. There is little difference between timber and lumber revetments except the raw materials. They are both built like plywood walls, except that the inside facing material is either saplings or lumber (**Figure 5.22**). The facing timbers of the timber revetment are usually 2- to 3-inch sapling trunks laid parallel, one on top of the other and fitted together to avoid gaps. The facing lumber of a lumber revetment is a minimum 2-inch thick board or 2 inches of layered plywood sheathing. For a timber revetment, the posts are usually 6 inches in diameter and spaced no more than 2 feet apart, while lumber revetments use 2- by 4-inch studs spaced about 12 inches apart. The posts are normally set 2 feet into the ground for bracing and have 3 tie-cables run between opposite posts. One cable provides a tie at mid-height, while the other two cables are at about 1/6 the height from the top and the bottom, respectively. As a minimum, every other post is tied. The ends of the revetments are blocked with additional posts of timber or lumber; therefore, the minimum width of the revetment can be greater than the plywood wall type revetment. As a minimum, the walls are built in cells every 10 feet. A cross-braced wall is built within the lumber revetment by using 2 sets of 4-by 4-inch posts set 2 inches apart to create a slot on the inside of each wall. Then 2-inch thick lumber is stacked in the slot to create a cross-braced wall section. For the timber wall, two sets of the 6-inch diameter posts are set about 3 inches apart on each side of the wall. Cross members are notched and stacked to fit into the facing logs. Timber and lumber revetments are filled with soil to provide strength and stability for these expedient structures.

Figure 5.22. Timber and Lumber Revetments.



5.10. Sand Grid Revetments. Sand grids are prefabricated forms that expand into honeycomb-shaped cells used to confine fill material such as sand or gravel. Original grids were 38 inches wide, 8 inches high, and 20 feet long when expanded. Grids with varying sizes (e.g., widths up to 8 feet) are now available. **Figure 5.23** illustrates how sand grid revetments are constructed. Grids are laid out over metal pickets at each end and stacked one layer upon the next. The maximum freestanding height for a revetment 38 inches wide is 8 feet (12 layers), although only a height of 6 feet (9 layers) are recommended unless additional picket anchors are added to the standard anchors. To achieve additional height, lower rows should be laid with either wider sand grids or additional rows of sand grids run parallel, face to face. Middle and upper rows are made with narrower sand grids. Make sure all rows have anchor pickets or additional intermediate pickets extending to several adjoining layers. If rows are run parallel, face to face, tie the rows together for stability. To prevent erosion and soil loss with sand grids that are not notched, place a geotextile fabric between each layer of sand grid and cover the top layer with impervious sheeting and sandbags. For additional details on constructing sand grids, refer to the manufacturer's instructions or access [TCMS](#).

Figure 5.23. Sand Grid Revetment Construction.



5.11. Earth-Filled Container Revetments. Earth-filled container revetments have proven to be very effective in protecting critical assets in expeditionary environments. When planning to use these materials for revetment construction, keep in mind that small hand tools and heavy equipment, such as front-end loaders, cranes with buckets and dump trucks, will also be needed. The following paragraphs describe typical construction of a revetment using earth-filled containers. For details on infill procedures, refer to [Chapter 2](#). In addition, detailed information on constructing various types of revetments using wire mesh containers can be found in the manufacturer's instructions or downloaded from [TCMS](#).

5.11.1. Site Selection and Preparation. Revetments must be constructed on well-drained, flat, and stable surfaces. If necessary, follow the guidance in Chapter 2 to improve surface areas where revetments will be constructed.

5.11.2. Materials. Constructing a revetment 9 feet high and 8 feet long might require approximately 6 sections of wire mesh container sections, assuming there are 9 bays per section, and each bay is 56 inches high and 42 inches wide.

5.11.3. First Layer. Once a site is selected, lay out the units as depicted in [Figure 5.24](#), ensuring the attached plastic wire ties are located at the top. Overlap the coil hinges located at the common corners between sections, and insert the connecting pin ([Figure 5.25](#)). Once all three sections of the first layer are connected, expand the bays 2 to 4 inches and begin filling the corner bays, and then every 8th to 12th bay thereafter with 1 foot of lightly compacted fill placed in two 6-inch lifts to anchor the layer for the remaining fill. Once anchored, fill the remaining bays. Use manual hand tampers or lightly compact the fill material by foot – do not use compacting equipment.

5.11.4. Second Layer. Arrange units as illustrated in [Figure 5.26](#). Connect the second layer to the first layer using the plastic ties. Fill the units with soil and make sure it is very well compacted. Upon completing the second layer, conduct a quick visual inspection, making sure the walls are straight, there is no excessive movement of the walls, and that adequate clear distance is provided between the walls.

Figure 5.24. Earth-Filled Container Revetment – First Layer.

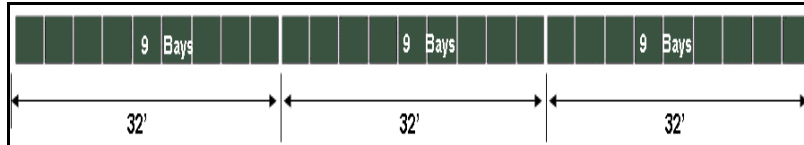


Figure 5.25. Coil Hinges and Connecting Pin.

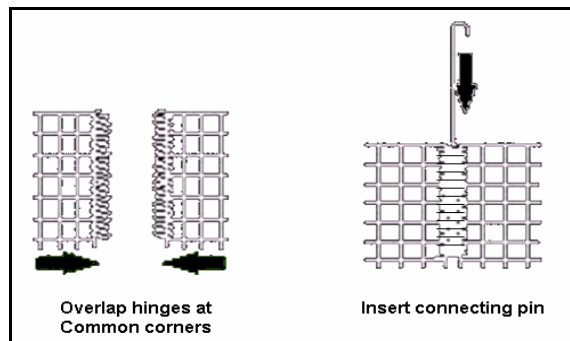
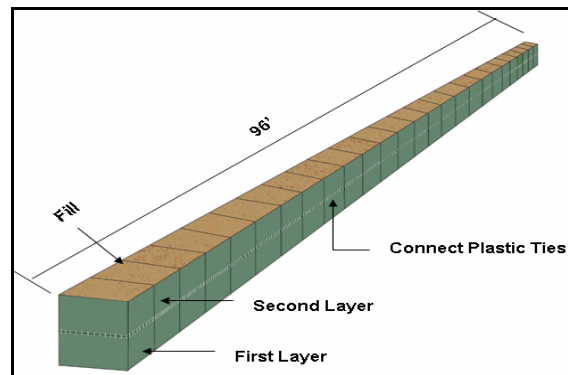


Figure 5.26. Earth-Filled Container Revetment – Second Layer.



5.12. Siting Revetments. Revetments must be properly sited to mitigate the effects of blast and fragmentation. Some basic principles for siting large structural revetments are listed in **Table 5.3**. In general, revetments should be sited as close as possible to protected assets. If not, fragmentation effects may be mitigated but the blast overpressure can still cause damage since blast waves tend to reform after traveling over objects. **Figure 5.27** and **Figure 5.28** are examples of improperly and properly sited revetments. When siting revetments, safe operational clearance for assets such as aircraft must also be considered. With the exception of revetments designed for parked aircraft, most revetments are designed to prevent straight-in access to the assets being protected. Aircraft revetments, in particular must be arranged in a manner that prevents propagation between cells of multiple revetments. This is a major concern for engineers. When aircraft loaded with cannon rounds, rockets, missiles, and bombs are exposed to extreme heat from a detonation or from other burning aircraft, the weapons may tend to cook-off and detonate or launch. By dispersing aircraft such that cells do not face each other and fuel drains away from other aircraft, propagation can be limited (**Figure 5.29**). If dispersal is not possible, such as on an aircraft parking or refueling ramp, clusters of revetments (**Figure 5.30**) can be used. **Figure 5.31** illustrates

Table 5.3. Principles for Siting Large Structural Revetments.

Step	Action
1	Align revetments in a manner that will block direct paths to the protected asset and prevent or mitigate the effects of fragmentation from a nearby weapons detonation
2	Extend revetments far enough past the protected asset to cut down the angles of exposure.
3	Where revetments are not connected, overlap them to eliminate any direct paths to the protected assets
4	If revetments cannot be overlapped (e.g., entrance corners), develop alternative methods for protecting the assets from the effects of blast and fragmentation at these openings (i.e., portable concrete revetments, sandbag revetments, etc.).
5	When angles of exposure cannot be decreased (e.g. aircraft revetments), do not place decoys in areas to block exposure

Figure 5.27. Improperly Sited Revetment.

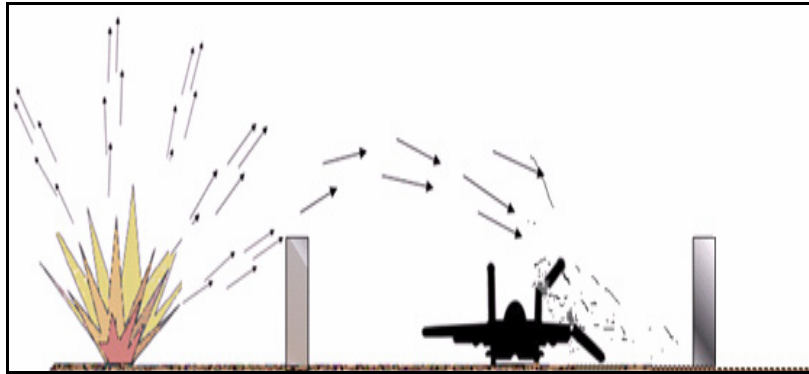


Figure 5.28. Properly Sited Revetment.

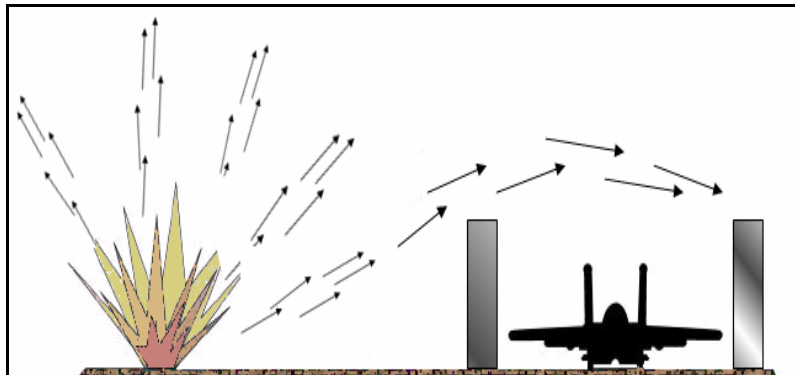
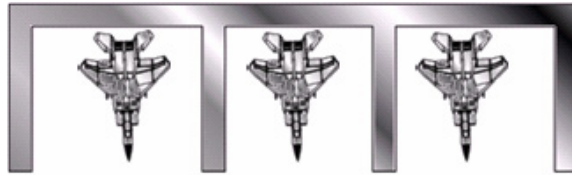


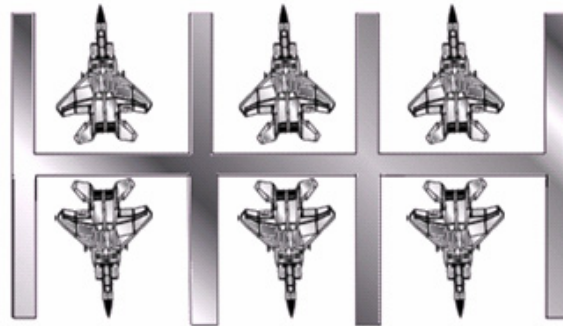
Figure 5.29. Dispersed Pattern for Aircraft Revetments.



Figure 5.30. Clustered Patterns for Aircraft Revetments.



U-SHAPED CLUSTER

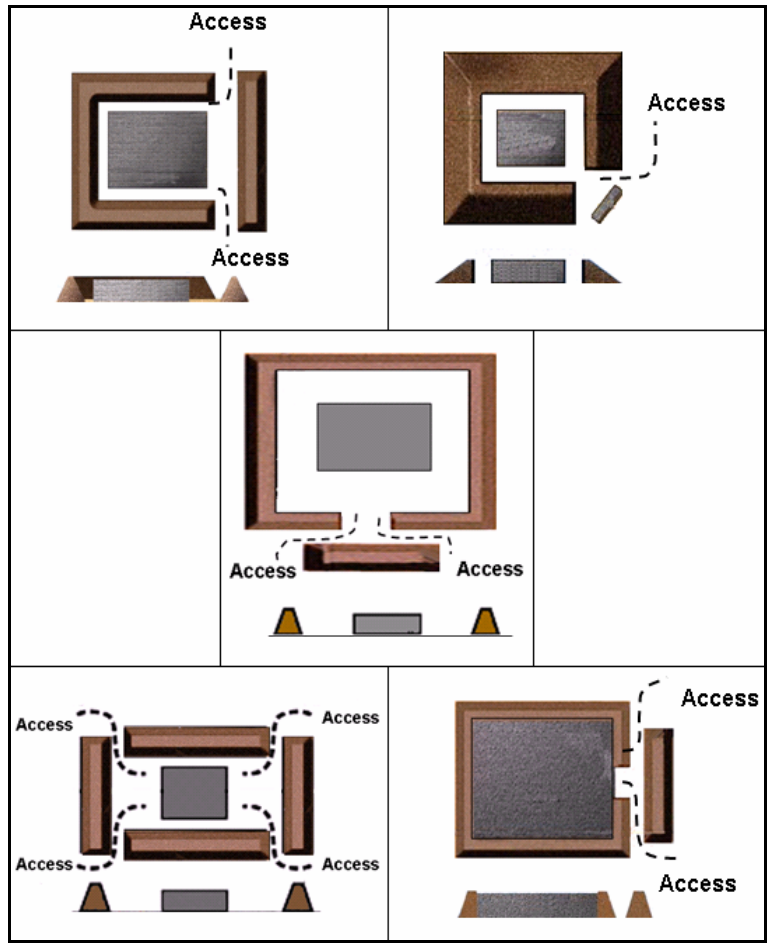


H-SHAPED CLUSTER



DRIVE-THROUGH CLUSTER

Figure 5.31. General Examples of Siting Revetments.



5.13. Prescribed Forms:

None.

5.14. Adopted Forms:

None.

KEVIN J. SULLIVAN, Lt Gen, USAF
DCS/Logistics, Installations and Mission Support



Attachment 1

GLOSSARY OF REFERENCES AND SUPPORTING INFORMATION

References

- AFPD 31-1, *Integrated Base Defense*, 7 July 2007
- AFDD 2-4, *Combat Support*, 23 March 2005
- AFDD 2-4.1, *Force Protection*, 9 November 2004
- AFI 10-245, *Air Force Antiterrorism (AT) Standards*, 21 June 2002
- AFI 10-2501, *Air Force Emergency Management (EM) Program Planning and Operations*, 24 January 2007
- AFJMAN 32-1034, *Materials Testing*, 17 August 1987
- AFMAN 10-2602, *Nuclear, Biological, Chemical, and Conventional (NBCC) Defense Operations and Standards*, 29 May 2003
- AFH 10-222, Volume 1, *Guide to Bare Base Development*, 1 February 2006
- AFH 10-222, Volume 2, *Guide to Bare Base Assets*, 1 April 2006
- AFH 10-222, Volume 3, *Guide to Civil Engineer Force Protection*, 1 June 1997
- AFH 10-222, Volume 14, *Guide to Fighting Positions, Obstacles, and Revetments*, 1 November 2000
- AFH 10-2401, *Force Protection Battlelab Vehicle Bomb Mitigation Guide (FOUO)*, 1 September 2006
- AFTTP(I) 3-2.34, *Risk Management*, 15 February 2001
- AFTTP 3-10.1, *Integrated Base Defense*, 20 August 2004
- AR 525-13, *Antiterrorism*, 4 January 2002
- FM 5-103, *Survivability*, 10 June 1985
- FM 5-410, *Military Soils Engineering*, 23 December 1992

- UFC 3-220-10N, *Soil Mechanics*, 8 June 2005
- UFC 3-340-01, *Design and Analysis of Hardened Structures to Conventional Weapons Effects*, 1 June 2002
- UFC 4-010-01, *DOD Minimum Antiterrorism Standards for Buildings*, 8 October 2003
- UFC 4-010-02 (FOUO), *DOD Minimum Antiterrorism Standoff Distances for Buildings*, 8 October 2003
- UFC 4-020-01, *DOD Security Engineering Facilities Planning Manual*, 1 March 2006
- UFC 4-021-01, *Design and O&M: Mass Notification Systems*, 20 September 2006
- UFC 4-022-01, *Security Engineering: Entry Control Facilities/Access Control Points*, 25 May 2005
- UFC 4-022-02, *Selection and Application of Vehicle Barriers*, 10 February 2005
- MIL-HDBK-1013/1A, *Design Guidelines for Physical Security of Facilities*, 15 December 1993
- MIL-HDBK-1013/10, *Design Guidelines for Security Fencing, Gates, Barriers, and Guard Facilities*, 14 May 1993
- JP 1-02, *DOD Dictionary of Military and Associated Terms*, 12 April 2001
- JP 3-07.2, *Joint Tactics, Techniques, and Procedures for Antiterrorism* (FOUO), 8 December 2004
- JP 3-13.3, *Operations Security*, 29 June 2006
- JP 3-15, *Barriers, Obstacles, and Mine Warfare for Joint Operations*, 26 April 2007
- JP 3-34, *Joint Engineer Operations*, 12 February 2007
- DOD 2000-12, *DOD Antiterrorism Program*, 18 August 2003

DODI 2000.16, *DOD Antiterrorism (AT) Standards*, 2 October 2006

DOD O-2000.12-H, *DOD Antiterrorism Handbook (FOUO)*, 9 February 2004

DOD 5200.8-R, *Physical Security Program*, 9 April 2007

Abbreviations and Acronyms

AFCS—Army Facilities Component System

AFH—Air Force Handbook

AFMAN—Air Force Manual

AFOSI—Air Force Office of Special Investigations

AFTTP—Air Force Tactics, Techniques, and Procedures

AFRL—Air Force Resources Laboratory

AT—Antiterrorism

ATEP—Antiterrorism Enterprise Portal

BEEM—Blast Effects Estimation Model

CbTRIF—Combating Terrorism Readiness Initiative Fund

CCD—Concealment, Camouflage, and Deception

DIA—Defense Intelligence Agency

DOD—Department of Defense

DTRA—Defense Threat Reduction Agency

ERDC—Engineer Research and Development Center

ETL—Engineering Technical Letter

FM—Field Manual

FOUO—For Official Use Only

FP—Force Protection
FPCON—Force Protection Condition
GTA—Government Training Aid
ISO—International Organization for Standardization
JCOB—Joint Contingency Operations Base
JFOB—Joint Forces Operations Base
JOCATAS— Joint Committee on Tactical Shelters
LAW—Light Antitank Weapon
MAJCOM—Major Command
MTT—Mobile Training Team
NBC—Nuclear, Biological, and Chemical
OCONUS—Outside the Continental United States
OPR—Office of Primary Responsibility
OSI—Office of Special Investigations
PDC—Protective Design Center
PWS—Performance Work Statement
RAM—Random Antiterrorism Measures; Rockets, Artillery, and Mortars
RDS—Records Disposition Schedule
SEA Hut—Southeast Asia Hut
SWA—Southwest Asia
TCMS—Theater Construction Management System
TTP—Tactics, Techniques, and Procedures
UFC—Unified Facilities Criteria

USACE—United States Army Corps of Engineers

UFGS—Unified Facilities Guide Specifications

USCS—Unified Soil Classification System

USAMC—US Army Materiel Command

UV—Ultraviolet

VA—Vulnerability Assessment

VAC—Volts Alternating Current

VBIED—Vehicle-borne Improvised Explosive Device

WBDG—Whole Building Design Guide

WMD—Weapons of Mass Destruction

Terms

Antiterrorism—Defensive measures used to reduce the vulnerability of individuals and property to terrorist acts, to include limited response and containment by local military forces. Also called AT.

Building Hardening—Enhanced conventional construction that mitigates threat hazards where standoff distance is limited. Building hardening may also be considered to include the prohibition of certain building materials and construction techniques.

Building Separation—The distance between closest points on the exterior walls of adjacent buildings or structures.

Combating Terrorism—Combating terrorism within the DOD encompasses all actions, including antiterrorism (defensive measures taken to reduce vulnerability to terrorist acts), counterterrorism (offensive measures taken to prevent, deter, and respond to terrorism), terrorism consequence management (preparation for and response to the consequences of a terrorist incident/event), and intelligence support (collection and dissemination of terrorism-related information) taken to oppose terrorism throughout the entire

threat spectrum, to include terrorist use of chemical, biological, radiological, nuclear materials or high-yield explosive devices (CBRNE).

Controlled Perimeter—A physical boundary at the perimeter of a site where vehicle access is controlled, an area within an installation, or another area with restricted access. A physical boundary sufficient to channel vehicles to access control points. Access control at a controlled perimeter requires the demonstrated capability to search for and detect explosives. Where the controlled perimeter includes a shoreline and there is no defined perimeter beyond the shoreline, the boundary will be at the mean high water mark.

Counterterrorism—Offensive measures taken to prevent, deter, and respond to terrorism. Also called CT.

Criticality Assessment—The process used to systematically identify key assets (i.e., personnel, equipment, buildings, etc.) based on their importance to the mission or function and are deemed mission critical by commanders.

Deterrence—The prevention from action by fear of the consequences based on the existence of a credible threat of unacceptable counteraction.

DOD Building—Any building or portion of a building (permanent, temporary, or expeditionary) owned, leased, privatized, or otherwise occupied, managed, or controlled by or for DOD. DOD buildings are categorized as uninhabited, inhabited, primary gathering, and billeting.

Expeditionary Structures—Those structures intended to be inhabited for no more than 1 year after they are erected. This group of structures typically includes tents, Small and Medium Shelter Systems, Expandable Shelter Containers (ESC), ISO and CONEX containers, General Purpose (GP) Medium tents, and GP Large tents.

Force Protection—Commander's program designed to protect Service members, civilian employees, family members, facilities, information, and equipment in all locations and situations; accomplished through planned and integrated application of combating terrorism, physical security, operations security, and personal protective services and supported by intelligence, counter-intelligence, and other security programs.

Improvised Explosive Device (IED)—Device fabricated in an improvised manner incorporating destructive, lethal, noxious, pyrotechnic, or incendiary chemicals designed to destroy, incapacitate, harass, or distract. May incorporate military stores but usually made from nonmilitary components.

Information Security—Protection of classified information that is stored on computers or transmitted by radio, telephone, or any other means.

Inhabited Building—Buildings or portions of buildings routinely occupied by 11 or more DOD personnel and with a population density of greater than one person per 40 gross square meters (430 gross square feet). This density generally excludes industrial, maintenance, and storage facilities, except for more densely populated portions of those buildings such as administrative areas. The inhabited building designation also applies to expeditionary and temporary structures with similar population densities. In a building that meets the criterion of having 11 or more personnel, with portions that do not have sufficient population densities to qualify as inhabited buildings, those portions that have sufficient population densities will be considered inhabited buildings while the remainder of the building may be considered uninhabited, subject to provisions of these standards. EXAMPLE: a hangar with an administrative area. The administrative area would be treated as an inhabited building and the remainder of the hangar could be treated as uninhabited.

Level of Protection—The degree to which an asset (person, equipment, object, etc.) is protected against injury or damage from an attack.

Obscuration Screen—A physical structure or some other element used to block the line of sight to a potential target.

Obstacle—Any obstruction designed or employed to disrupt, fix, turn, or block movement of an opposing force, and to impose additional losses in personnel, time, and equipment on the opposing force. Obstacles can exist naturally, be constructed, or a combination of both.

Operations Security—An analytic process used to deny an adversary information - generally unclassified - concerning friendly intentions and capabilities by identifying, controlling, and protecting indicators associated with

planning processes or operations. OPSEC does not replace other security disciplines - it supplements them.

Passive Defense—Measures taken to reduce the probability of and to minimize the effects of damage caused by hostile action without the intention of taking the initiative.

Perimeter Security—Security elements that form the first line of defense for a site or installation. Elements include standoff, physical barriers, access control, entry control points, security lighting, hardened fighting positions and overwatch towers, intrusion detection and surveillance systems, and security forces.

Physical Security—That part of security concerned with physical measures designed to safeguard personnel; to prevent unauthorized access to equipment, installations, material, and documents; and to safeguard them against espionage, sabotage, damage, and theft.

Predetonation Screen—A structure designed to protect a critical asset by causing a weapon to detonate prior to hitting the primary target, causing its effect to dissipate in the distance between the screen and the target.

Revetment—A raised structure that provides a level of protection against splinters, shrapnel, and/or projectiles from bombs, rockets, grenades, small arms fire, or other weapons effects.

Risk Management—The process of identifying, assessing, and controlling risks arising from operational factors and making decisions that balance risk cost with mission benefits.

Standoff Distance—A distance maintained between a building or portion thereof and the potential location for an explosive detonation.

Temporary Structures—Structures erected with an expected occupancy of three years or less. Typically includes wood-frame and rigid-wall construction and such things as Southeast Asia (SEA) Huts, hardback tents, ISO and CONEX containers, pre-engineered buildings, trailers, stress tensioned shelters, Expandable Shelter Containers (ESC), and Aircraft Hangars (ACH).

Terrorism—The calculated use of unlawful violence or threat of unlawful violence to inculcate fear. It is intended to coerce or to intimidate governments or societies in the pursuit of goals that are generally political, religious, or ideological.

Terrorist—An individual who uses violence, terror, and intimidation to achieve a result.

Terrorism Threat Analysis—In antiterrorism, threat analysis is a continual process of compiling and examining all available information concerning potential terrorist activists by groups that could target a facility. A threat analysis will review factors of the presence of a terrorist group, operational capability, activity, intentions, and operating environment.

Threat Assessment—The process used to conduct a threat analysis and develop an evaluation of a potential terrorist threat and the product of a threat analysis for a particular unit, installation, or activity.

Terrorist Threat Level—A scale used by DOD intelligence agencies to describe the severity of terrorist threats. The terrorist threat level is established by DIA and geographical combatant commanders and only applies to those threats to DOD interests.

Unified Facilities Criteria—The Unified Facilities Criteria (UFC) system is prescribed by MIL-STD 3007 and provides planning, design, construction, sustainment, restoration, and modernization criteria and applies to the Military Departments, the Defense Agencies, and the DOD Field Activities in accordance with USD(AT&L) Memorandum dated 29 May 2002. UFC will be used for all DOD projects and work for other customers where appropriate. UFCs are living documents and will be periodically reviewed, updated, and made available to users as part of the Services' responsibility for providing technical criteria for military construction. Headquarters US Army Corps of Engineers (HQUSACE), Naval Facilities Engineering Command (NAVFAC), and Air Force Civil Engineer Support Agency (AFCESA) are responsible for administration of the UFC system.

Vulnerability—In AT, a vulnerability is a situation or circumstance, which, if left unchanged, may result in the loss of life or damage to mission essential resources.

Vulnerability Assessment—A DOD, command, or unit-level evaluation conducted to determine how vulnerable installations, units, exercises, ports, ships, residences, facilities, or other sites are to terrorist attacks. Identifies areas of improvement needed to withstand, mitigate, or deter such acts.

Attachment 2

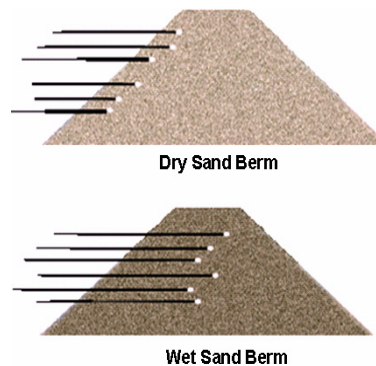
PROTECTIVE MATERIALS

A2.1. Overview. When planning and designing fighting positions, shelters, and other protective structures, it is important to know the characteristics of certain materials and how they might be affected by certain weapons. The following paragraphs describe materials that might be available and how these materials can be used effectively in the expeditionary environment.

A2.2. Characteristics of Materials. Engineers should be aware that different types of materials offer different degrees of protection. For protective construction efforts, certain materials can be used for shielding or as structural components to hold shielding materials in place.

A2.2.1. Soil. Soil can be an effective shield against direct fire, indirect fire, blast, or fragmentation effects. Dense soils offer more protection and resistance to penetration. Coarse-grained soils provide better protection than fine-grained soils with the same density. Dry sandy soil provides better protection than silt, clay, and silty-clay soils. Saturated soils offer a less degree of resistance to penetrating projectiles, as illustrated in [Figure A2.1](#). Wet clay is the most susceptible to ballistic penetration.

Figure A2.1. Soil Resistance to Penetration.



A2.2.2. **Concrete.** Steel reinforced concrete provides excellent protection against direct fire, indirect fire, and fragmentation. However, placement of concrete structures is important, as they are subject to fail when a large detonation occurs nearby and can themselves become secondary fragmentation.

A2.2.3. **Steel.** Steel provides excellent protection against fragmentation resulting from direct- and indirect-fired weapons. Obstacles made from steel can be effectively utilized to resist the effects of many types of weapons.

A2.2.4. **Rocks.** Rocks can be effective against direct and indirect fire and fragmentation. Hard rocks can deform, stop, or deflect projectiles. Small rocks and gravel can be used similar to soil and is less susceptible to moisture. A disadvantage of using rocks is that they can become weakened after multiple hits or become projectiles if dislodged by blast or upon impact.

A2.2.5. **Brick and Masonry.** Brick and masonry have similar characteristics of rocks against penetration and fragmentation effects. However, unreinforced brick and masonry do not afford the same protection as concrete because of less density.

A2.2.6. **Snow and Ice.** Snow and ice may be the only material available at some locations and may be effective against small caliber weapons and nearby blast when used in mass or in combination with frozen soil.

A2.2.7. **Lumber and Timber.** Wood (e.g., lumber, plywood, timber) has limited value in stopping projectiles or fragments due to its low density. This material needs to be very thick to stop small caliber and anti-tank weapons.

A2.2.8. **Miscellaneous Materials.** If available, miscellaneous materials, such as landing mats, cargo pallets, steel containers, and culverts provide some degree of protection from penetrating projectiles and fragmentation effects.

A2.3. Expedient Materials for Protection Against Explosions. **Table A2.1**, extracted from FM 5-103, contains thicknesses of materials needed to provide adequate protection from nearby explosions. In some cases, engineers must use whatever materials are available at the site to devise and construct structures needed to contain these shielding materials.

Table A2.1. Material Thickness for Protection Against Explosions (50 feet away).

Thickness of Material (Inches)	Mortar		Rocket	HE Shell		Bomb			
	82 mm	120 mm	122 mm	122 mm	152 Mm	100 lbs	250 lbs	500 lbs	1,000 lbs
Solid Walls									
Brick Masonry	4	6	6	6	8	8	10	13	17
Non-reinforced Concrete	4	5	5	5	6	8	10	15	18
Reinforced Concrete	3	4	4	4	5	7	9	12	15
Lumber	8	12	12	12	14	15	18	24	30
Structurally Supported Material									
Brick Rubble	9	12	12	12	12	18	24	28	30
Soil*	12	12	12	12	16	24	30	NR	NR
Gravel and Crushed Stone	9	12	12	12	12	18	24	28	30
Sandbags									
Brick Rubble	10	18	18	18	20	20	20	30	40
Dry Clay*	10	18	18	18	20	30	40	40	50
Gravel and Small Stones	10	18	18	18	20	20	20	30	40
Dry Sand*	8	16	16	16	18	30	30	40	40
Loose Parapets									
Dry Clay*	12	20	20	20	30	36	48	60	NR
Dry Sand*	10	18	18	18	24	24	36	36	48
Snow									
Tamped	60	60	60	60	60	NR	NR	NR	NR
Unpacked	60	60	60	60	60	NR	NR	NR	NR
Notes									
* Double the thickness when material is wet									
NR = material is not recommended									

A2.4. Table A2.2, extracted from FM 5-103, contains required thickness for materials to protect against projectiles. Except where indicated, the thickness of material shown can protect a target from a single strike from the weapon specified. If intelligence indicates the enemy may be capable of placing multiple projectiles upon an individual target or certain area, the thicknesses indicated in the table should be doubled. Refer to the JCOB and JFOB Force Protection Handbooks for additional information on the use of available materials to construct expedient fortifications in the expeditionary environment.

Table A2.2. Material Thickness for Protection Against Projectiles.

Material Thickness in Inches	Small Caliber Machine Gun- From 100 Yards	Antitank Rifle - From 100 Yards	20mm Anti-tank Round - From 200 Yards	37mm Anti-tank Round - From 400 Yards	50mm Anti-tank Round - From 400 Yards	75mm Round- From 500 to 1000 Yards	Note
Solid Walls							
Brick Masonry	18	24	30	60	NR	NR	1
Unreinforced Concrete	12	18	24	42	48	54	1
Reinforced Concrete	6	12	18	36	42	48	2
Stone Masonry	12	18	30	42	54	60	3
Timber	36	60	NR	NR	NR	NR	3
Lumber	24	36	48	NR	NR	NR	3
Structurally Supported Materials							
Brick Rubble	12	24	30	60	70	NR	
Dry Clay	36	48	NR	NR	NR	NR	4
Gravel and Small Crushed Rock	12	24	30	60	70	NR	
Dry Loam	24	36	48	NR	NR	NR	5
Dry Sand	12	24	30	60	70	NR	4
Sandbags							
Brick Rubble	20	30	30	60	70	NR	
Dry Clay	40	60	NR	NR	NR	NR	4
Gravel and Small Crushed Rock	20	30	30	60	70	NR	
Dry Loam	30	50	60	NR	NR	NR	5
Dry Sand	20	30	30	60	70	NR	4
Loose Parapets							

Material Thickness in Inches	Small Caliber Machine Gun- From 100 Yards	Antitank Rifle - From 100 Yards	20mm Anti-tank Round - From 200 Yards	37mm Anti-tank Round - From 400 Yards	50mm Anti-tank Round - From 400 Yards	75mm Round- From 500 to 1000 Yards	Note
Clay	42	60	NR	NR	NR	NR	4
Loam	36	48	60	NR	NR	NR	5
Sand	24	36	48	NR	NR	NR	4
Snow and Ice							
Frozen Snow	80	80	NR	NR	NR	NR	
Frozen Soil	24	24	NR	NR	NR	NR	
Ice + Aggregate	18	18	NR	NR	NR	NR	
Tamped Snow	72	72	NR	NR	NR	NR	
Unpacked Snow	180	180	NR	NR	NR	NR	
Notes							
1 – Plain formed concrete walls							
2 – Reinforced with steel							
3 – Guidance only							
4 – Double the thickness when wet							
5 – Add 50% to thickness when wet							
6 – Thickness to nearest ½ ft							
7 – 3,000 psi concrete							

Attachment 3

FIELD CLASSIFICATION OF SOILS

A3.1. Overview. Tests described in this attachment will help in classifying different types of soil in the field environment. These tests are based on information contained in AFJMAN 32-1034, *Materials Testing*, FM 5-410, *Military Soils Engineering*, and UFC 3-220-10N, *Soil Mechanics*. Engineers should become familiar with these references and ensure they are available during deployments.

A3.2. Soil Classification. The Unified Soil Classification System (USCS) divides soils into one of three major categories which include (1) coarse-grained, (2) fine-grained, and (3) highly organic. These soils are further divided into major categories based on their properties and characteristics. **Table A3.1** contains symbols used to group different types of soils and distinguish soils with different characteristics. These symbols are combined to further describe soils (e.g., GW = well-graded gravel).

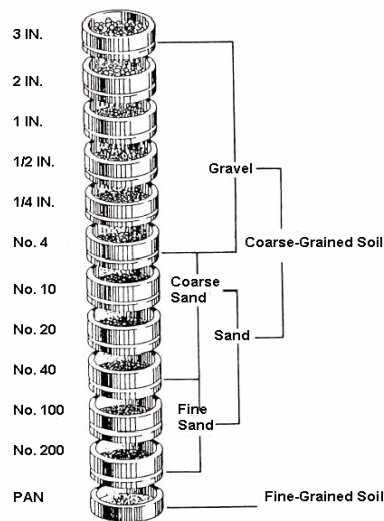
Table A3.1. Soil Groups and Characteristics

Soil Groups	
Group	Symbol
Gravel	G
Sand	S
Silt	M
Clay	C
Soil Characteristics	
Well graded	W
Poorly graded	P
High compressibility	H
Low compressibility	L
Organic (peat)	Pt
Organic (silts and clays)	O
Liquid limits under 50	L
Liquid limits over 50	H

A3.3. Field Classification and Testing. Although most tests can be performed without laboratory equipment, using No. 40 and No. 200 sieves provides better accuracy and speeds up testing. Sieves are screens attached across the end of a cylindrical metal frame. The screen allows particles smaller than its openings to fall through and retains larger particles. Sieves with screen openings of different sizes allow you to sort soil into particle groups based on size ([Figure A3.1](#)).

A3.3.1. Visual Examination. A visual examination can be used to establish the color, grain sizes, and grain shapes of the coarse-grained portion, some idea of the gradation; and some properties of the undisturbed soil. While visual examinations may require a large sample of soil, these tests can usually be conducted with a pint (approximately one canteen cup full) of soil. Soil samples should be taken from the levels of soil that will be exposed during construction and are related to the structural strength of the construction. For example, if soil needs to be tested for a fighting position, the sample should be taken from the exposed wall material that will be a part of the structure rather than the topsoil layer.

A3.3.1.1. Colors. Color helps to distinguish between soil types. It can also indicate the presence of certain chemicals or impurities. Colors in general become darker as moisture content increases and lighter as soil dries. Some fine-grained soils with dark, drab shades of brown or gray (including almost black) contain organic colloidal matter. Clean, bright shades of gray, olive green, brown, red, yellow, and white are associated with inorganic soils. Gray-blue or gray-and-yellow mottled colors frequently result from poor drainage. Red, yellow, and yellowish-brown soils result from the presence of iron oxides. White to pink soils may indicate considerable silica, calcium carbonate, or aluminum compounds.

Figure A3.1. Standard Sieve Set.

A3.3.1.2. Grain Sizes. The sample size of gravels range down to the size of peas, about 1/4-inch (e.g., materials retained on a No. 4 sieve). Sands start just below this size and decrease until individual grains are just distinguishable by the naked eye. The eye can normally see individual grains about 0.07 millimeters in size (about the size of the No. 200 sieve). Silt and clay particles, which are smaller than sands, are indistinguishable as individual particles.

A3.3.1.3. Grain Shapes. Shapes of visible particles can be determined while the sample is examined for grain sizes. Sharp edges and flat surfaces indicate angular shapes, while smooth, curved surfaces indicate rounded shapes. Some particles may not be completely angular or rounded. These shapes are referred to as either subangular or subrounded, depending on which shape predominates.

A3.3.1.4. **Distribution of Grain Sizes.** While laboratory analysis is needed to determine accurate distribution of grain sizes, a field approximation can be made by separating larger grains from the remainder of the soil. **Table A3.2** contains field methods for determining distribution of grain sizes.

Table A3.2. Distribution of Grain Sizes.

1	Separate larger grains (gravel and some sand particles down to about 1/8-inch and larger) from the remainder of the soil. Examine the remainder of the soil and estimate the proportion of visible individual particles (larger than No. 200 sieve) and the fines (smaller than No. 200 sieve). Convert these estimates into percentages by weight of the total sample.	If the fines exceed 50 percent, the soil is considered fine-grained (silt--M, clay--C, or organic--O). If the coarse material exceeds 50 percent, the soil is coarse-grained (gravel--G or sand--S)
2	Examine coarse-grained soil for gradation of particle sizes from the largest to the smallest	If there is a good distribution of all sizes, this means the soil is well-graded (W). If there is an overabundance or lack of any size, this means the material is poorly graded (P)
3	Estimate the percentage of the fine-grained portion of the coarse-grained soil	If less than 5 percent (non-plastic fines) of the total, the soil may be classified either as a GW, GP, SW, or SP type, depending on the other information noted above. If the fine-grained portion exceeds 12 percent, the soil will be either M or C and requires further testing to identify. If the fine-grained portion is between 5 and 12 percent (non-plastic fines or fines not interfering with free drainage), the soil is borderline and requires double symbols such as GW-GM or SW-SM. Note: Fine-grained soils (M, C, or O) require other tests to distinguish them further

A3.3.1.5. Undisturbed Soil Properties. Using characteristics determined up to this point, evaluate the soil as it appeared in place. Gravels or sands can be described qualitatively as loose, medium, or dense. Clays may be hard, stiff, or soft. The ease or difficulty with which the sample was removed from the ground is a good indicator. Soils that have been cultivated or farmed can be further evaluated as loose or compressible. Highly organic soils can be spongy or elastic. In addition, the moisture content of the soil influences the in-place characteristics. This condition should be recognized and reported with the undisturbed soil properties.

A3.3.2. Sedimentation Test. The visual observation test is used to approximate the proportions of sand and gravel in a soil by spreading the dry sample out on a flat surface and separating the gravel particles by hand. When No. 40 and No. 200 sieves are not available, separating the fines from the sand particles is achieved by the sedimentation test. Place a small amount of the fine fraction of soil, such as a heaping tablespoon, in a transparent container, such as a jar. Break up any lumps of soil (especially the clays) by grinding the soil in a canteen cup and add it back to the container. Cover the sample with about 5 inches of water and agitate by stirring or shaking. The soil particles will settle out in the time periods indicated in [Table A3.3](#).

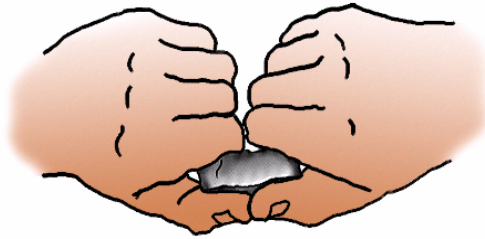
Table A3.3. Sedimentation Test Settling Times.

Approximate Settlement Time (5 inches of water)	Grain Diameter (mm/inch)	Differentiates
2 Seconds	0.4 / 0.0157	Coarse Sand – Fine Sand
30 Seconds	0.072 / 0.0028	Sand – Fines
10 Minutes	0.03 / 0.0118	Coarse Silt – Fine Silt
1 Hour	0.01 / 0.00039	Silt – Clay

A3.3.3. Results of Sedimentation Test. The test will differentiate the coarse fraction from the fine fraction of a soil. The coarse materials are larger than 0.4 mm and would be retained on a No. 40 sieve. Fine sands fall between 0.4 mm and 0.7 mm. The fine materials will be less than 0.072 mm and would be material passing a No. 200 sieve. To obtain the fines, wait 30 seconds after shaking and then gently pour the liquid with suspended fines into another container. Add additional water to the original container and shake again. Repeat the above process with the just used sample, again waiting 30 seconds and pouring the clearer liquid into the second container. Repeat until the liquid appears clear. Pour the water with the fines into a flat pan; dry the soil in the container (i.e., the sand) and the soil in the pan (i.e., the fines) by letting the water be wicked or evaporated off. Determine the relative amounts of fines and sand.

A3.3.4. Modified Sedimentation Test. For the numerous tests that require use of all fines (i.e., the fines and fine sand materials passing a No. 40 sieve), the above procedure can be modified to provide this test material. Take a sample of the original material and separate out the gravel particles by hand. Place a small amount of the fine fraction of soil in a transparent container and break up any lumps of soil (especially if clay) by grinding the soil in a canteen cup with an improvised wood pestle and add back to the container. Cover the sample with about 5 inches of water and agitate by stirring or shaking. Between 1 and 2 seconds after stopping the agitation, pour off the water with the suspended materials into a flat pan and dry the soil. The soil in the pan will contain particles in the fine and fine sand range.

A3.3.5. Breaking or Dry Strength Test and Powder Test. Perform these tests only on material passing the No. 40 sieve. Prepare a pat of soil about 2 inches in diameter and ½-inch thick by molding it in a wet, plastic state. Allow the pat to dry completely. Once dried, grasp the pat between the thumbs and forefingers of both hands and attempt to break it. [Figure A3.2](#) illustrates the proper way to hold the pat. If the pat breaks, perform the “Powder Test” by taking a portion of the broken pat and rubbing it with the thumb in an attempt to flake particles off. [Table A3.4](#) can be used to draw conclusions from these tests.

Figure A3.2. Proper Handling for Breaking or Dry Strength Test.**Table A3.4. Dry Strength and Breaking Test Results and Indications.**

Result	Indication
Pat cannot be broken nor powdered by finger pressure	Very highly plastic soil (CH)
Pat can be broken with great effort, but cannot be powdered	Highly plastic soil (CL)
Pat can be broken and powdered, but with some effort	Medium plastic soil (CL)
Pat breaks quite easily and powders readily	Slightly plastic soil (ML, MH, or CL)
Pat has little or no dry strength and crumbles or powders when picked up	Non-plastic soil (ML or MH) or (OL or OH)
Note: Dry pats of highly plastic clays quite often display shrinkage cracks. Make sure when performing this test not to break the sample along shrinkage cracks	

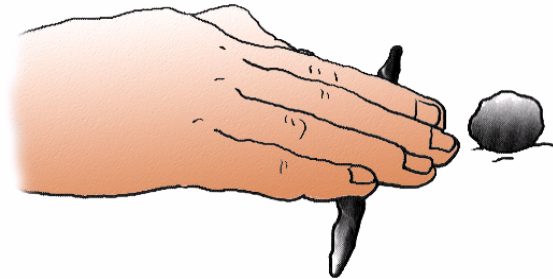
A3.3.6. Odor Test. The odor test is performed by taking a small representative sample and heating it with an open flame, such as a match or a candle. Check for odor. Organic soils (OL and OH) usually have a distinctive, musty, slightly offensive odor.

A3.3.7. Cast Test. The cast test is performed by mixing a representative portion of the sample with water until it can be molded or shaped without sticking to the fingers. Compress the soil into a ball or cigar-shaped cast. Observe the ability of the sample to withstand handling without crumbling. Use [Table A3.5](#) to draw conclusions based on the cast test.

Table A3.5. Cast Test Results and Indications.

Result	Indication
Cast crumbles when touched, such as when lightly pushed with a finger	Sample is sand with little to no fines (SW or SP)
Cast withstands careful handling, such as lightly passing the cast back and forth between hands	Sample is sand with an appreciable amount of fines (SM or SC)
Cast can be handled freely or withstands rough handling	Sample is silt, clay, or an organic

A3.3.8. Roll or Thread Test. This test is performed only on the material passing the No. 40 sieve. A portion of the sample is mixed with water until it can be molded or shaped without sticking to the fingers. Shape the sample into a ball or an elongated cylinder and roll the prepared soil cylinder (on a flat, nonabsorbent surface) rapidly into a thread approximately 1/8-inch in diameter. The technique is shown in [Figure A3.3](#). If the moist soil rolls into a thread, it is said to have some plasticity. Plasticity is a property of the fine-grained portion of a soil that allows it to be deformed beyond the point of recovery without cracking or appreciable volume change. This property permits clay to be rolled into thin threads at some moisture content without crumbling. Some minerals, such as quartz powder, cannot be made plastic no matter how fine the particles nor how much water is added. Thus, the degree of plasticity is a general index to the clay content of a soil. The number of times it can be lumped back together and rolled into a thread without crumbling is a measure of the degree of plasticity of the soil. Materials that cannot be rolled in this manner are non-plastic or have a very low plasticity. [Table A3.6](#) can be used to draw conclusions for the roll or thread test.

Figure A3.3. Roll or Thread Test Technique.**Table A3.6. Roll or Thread Test Results and Indications.**

Result	Indication
Soil can be molded into a ball or cylinder and deformed under very firm finger pressure without crumbling or cracking	High plasticity (CH)
Soil can be remolded into a ball, but it cracks or crumbles under finger pressure	Medium plasticity (CL)
Soil cannot be lumped into a ball or cylinder without breaking up	Low plasticity (CL, ML, or MH)
Soil forms a soft, spongy ball or thread when molded	Organic material (OL or OH), also peat
Soil cannot be rolled into a thread at any moisture content	Non-plastic soil (ML or MH)
Note: Micaceous silts and sands may be rolled due to the flaky nature of the mica	

A3.3.9. Ribbon Test. This test is also performed only on material passing the No. 40 sieve. A representative portion of the sample is mixed with water until it can be molded or shaped without sticking to the fingers. Form a roll of soil about $\frac{1}{2}$ - to $\frac{3}{4}$ -inches in diameter and 3 to 5 inches long. Lay the roll across the palm of one hand (palm up), and starting at one end, squeeze the roll between the thumb and forefinger over the edge of the hand to form a flat, unbroken ribbon about $\frac{1}{2}$ to $\frac{3}{4}$ inches thick. Allow the ribbon as formed to hang free and unsupported (**Figure A3.4**). Continue squeezing and handling the roll carefully to form the maximum length of ribbon that can be supported only by the cohesive properties of the soil. Use **Table A3.7** to draw conclusions.

Figure A3.4. Ribbon Test Technique.



Table A3.7. Ribbon Test Results and Indications.

Result	Indication
Sample holds together for a length of 8 to 10 inches without breaking	Highly plastic and highly compressive (CH)
Soil can be ribboned only with difficulty into 3-inch to 8-inch lengths	Low plasticity (CL)

A3.3.10. Wet Shaking Test. The wet shaking test is performed only on the material passing the No. 40 sieve (see [Figure A3.5](#) for illustrations). A representative portion of the sample (enough material to form a ball of material about 3/4-inch in diameter) is mixed with water until it can be molded or shaped without sticking to the fingers. The sample (soil pat) is then spread across the palm of the hand with the blade of a knife or small spatula. Shake the hand with the soil pat horizontally and strike that hand vigorously with the other hand. Check the soil for a reaction where water comes to the surface, producing a smooth, shiny appearance. This appearance is described as livery. Squeeze the sample between the thumb and forefinger using the other hand. Check to see if the surface water quickly disappears, the surface becomes dull, and the material becomes firm, resisting deformation. Continue to apply pressure and check to see if cracks occur and the sample crumbles like a brittle material. Very fine sands and silts can be readily identified with the wet shaking test. However, it is rare to find fine sands and silts without some amount of clay, which causes varying reactions to the wet shaking test. Even a small amount of clay will tend to greatly retard this reaction when the water comes to the surface. [Table A3.8](#) can be used to draw conclusions using the wet shaking test.

Figure A3.5. Illustration of Wet Shaking Test.

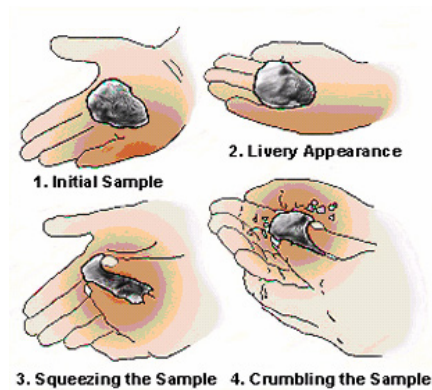


Table A3.8. Wet Shaking Test Results and Indications.

Result	Indications
Test causes a rapid reaction	Nonplastic, fine sand and soils
Test causes a sluggish reaction	Slight plasticity (such as might be found in some organic silts) or silts containing a small amount of clay
Test causes no reaction	Sample is clayey

A3.3.11. **Bite/Grit Test.** To conduct the bite test, bite down on a small sample and draw conclusions using [Table A3.9](#).

Table A3.9. Bite/Grit Test Results and Indications.

Result	Indications
Sample feels gritty and grates the teeth	Sample is sandy
Sample feels only slightly harsh	Sample is silty
Sample feels like flour (smooth and powdery)	Sample is clayey

A3.3.12. **Shine Test.** This test is performed only on the material passing through the No. 40 sieve. To conduct this test, take a small, slightly moist pat sample and rub a fingernail or a smooth metal surface such as a knife blade across the sample. Use [Table A3.10](#) to draw conclusions using the shine test.

Table A3.10. Shine Test Results and Indications.

Result	Indications
Test produces a definite shine	Material is a highly plastic clay (CH)
Sample remains dull	Material is a low compressible clay (CL)
Surface of the sample remains very dull or appears granular	Sample is a silt or sand

A3.3.13. Wash, Dust and Smear Test. The wash, dust, and smear test involves a couple of methods with varying results. Only material passing through the No. 40 sieve is used for this test. For the first method, take a small, completely dry sample of soil and drop it from a height of 1 to 2 feet above a clean, solid surface. Acknowledge the results to determine the amount of dust that is produced. Refer to **Table A3.11** to draw conclusions. The second method involves taking a small amount of soil and adding water to it until it is moist but does not stick to the fingers. The sample is then smeared between the thumb and forefinger. Acknowledge the results and again use **Table A3.11** to draw conclusions.

Table A3.11. Wash, Dust, and Smear Test Results and Indications.

Result	Indications
First Method	
Fairly large amount of dust produced	Sample is a silty sand (SM)
Very little dust is produced	Sample is clean sand. Check the gradation (SW or SP)
Second Method	
Test produces a gritty, harsh feel	Sample contains a small amount of silt. Check the gradation (SW or SP)
Test produces a rough but less harsh feel	Soil contains about 10 percent silt (SM)

A3.3.14. Feel Test. Perform feel tests only with material passing the No. 40 sieve. This is done by rubbing the sample between the fingers and observing the texture. Determine if it is floury, smooth, gritty, or sharp. Rub the sample on the inside of the wrist. Sand will feel gritty and silts (if dry) will dust readily and feel soft and silky. Clay will powder with difficulty, but feel smooth and gritless like flour. If the sample is clay, squeeze a piece of the undisturbed soil between the thumb and forefinger to determine its consistency. Remold the soil by working it between the hands and observe the results. If the sample becomes fluid, it is clay that is probably near the liquid limit. If the sample remains stiff and crumbles when reworked, it is probably clay below the plastic limit.

A3.4. Plasticity Estimation. To obtain the range of plasticity of soils (amount of clay material), conduct the following test using a small sample. First, remove all particles coarser than a grain of salt. Mold the remaining particles into a small cube (about 3/4-inch), adding enough moisture to obtain a putty-like consistency, then allow it to air dry. Once dry, place the cube between the forefinger and thumb and squeeze to crush it. Use [Table A3.12](#) to determine the sample's plasticity.

Table A3.12. Results and Indications of Plasticity.

Result	Indication
Cube falls apart easily	Soil is nonplastic
Cube is easily crushed	Soil is slightly plastic
Cube is difficult to crush	Soil is medium plastic
Cube is impossible to crush	Soil is highly plastic