

**BY ORDER OF THE COMMANDER
PACIFIC AIR FORCES**

**PACIFIC AIR FORCE INSTRUCTION
21-105**



19 JANUARY 2023

**8TH FIGHTER WING
Supplement**

12 MARCH 2026

Maintenance

FABRICATION PROGRAM

COMPLIANCE WITH THIS PUBLICATION IS MANDATORY

ACCESSIBILITY: Publications and forms are available on the e-Publishing website at www.e-publishing.af.mil.

RELEASABILITY: There are no releasability restrictions on this publication

OPR: PACAF/A4MM

Certified by: PACAF/A4M
(GS-14 Darrell S. Mosley)

Supersedes: PACAFI 21-105, 13 September 2018

Pages: 73

(8FW)

OPR: 8MXG/MXMF

Certified by: 8MXG/CC
(Colonel Blair W. Byrem)

Supersedes: CAFI21-105_8FWSUP, 5 April 2023

Pages: 73

This publication implements Air Force Policy Directive (AFPD) 21-1, *Maintenance of Military Materiel*; and is consistent with AFPD 13-5, *Air Force Nuclear Enterprise*. It is the basic Air Force instruction (AFI) for all weapon system and support equipment maintenance management guidance. It provides the minimum essential guidance and procedures to safely and effectively maintain, service, and repair weapon systems and support equipment. This publication applies to all PACAF units and AFRC/ANG (ARC) Classic Associate units. It does not apply to United States Space Force. This publication may be supplemented at any level, but supplements to this publication are not required to be sent to the OPR for review unless they have deviations. The authorities to waive wing/unit level requirements in this publication are identified with a Tier (T-2, T-3) number following the compliance statement. Waivers for T-2 or non-tiered compliance items will be sent to PACAF/A4M, pacaf.a4mv3@us.af.mil. See Department of the Air Force Manual (DAFMAN) 90-161, *Publishing Processes and Procedures*, for a description of the authorities associated with tier numbers. Refer recommended changes and questions about this publication

through the appropriate functional chain of command to the Office of Primary Responsibility (OPR) using the DAF Form 847, *Recommendation for Change of Publication*. Ensure all records generated as a result of processes prescribed in this publication adhere to AFI 33-322, *Records Management and Information Governance Program*, and are disposed in accordance with the Air Force Records Disposition Schedule, which is located in the Air Force Records Information Management System. The use of the name or mark of any specific manufacturer, commercial product, commodity, or service in this publication does not imply endorsement by the Department of the Air Force.

(8FW) This supplement implements Air Force Policy Directive (AFPD) 21-1, *Maintenance of Military Materiel*, and fulfills the requirement of Combat Air Force Instruction (CAFI) 21-105, *Fabrication Program*, by establishing procedures for: Wing Corrosion Program Manager Responsibilities, Aircraft Structural Maintenance (ASM) Responsibilities, Maintenance Operations Officer Responsibilities, Wash Crew Supervisor Responsibilities, Aerospace Ground Equipment (AGE) Flight Chief Responsibilities, and Unit Corrosion Control Program Requirements. Unit commanders and supervisors are responsible for compliance with the provisions of this instruction. Commanders and supervisors will ensure that all personnel subject to operations covered by this instruction are thoroughly knowledgeable of the inherent dangers of the operation and the safety precautions necessary for safe and efficient accomplishment. It is applicable to all 8th Fighter Wing aircraft, transient aircraft and units deployed to Kunsan Air Base, Korea. Refer recommended changes and questions about this publication to the Office of Primary Responsibility (OPR) using the AF Form 847, Recommendation for Change of Publication; route the AF Forms 847 from the field through the appropriate functional chain of command. Ensure that all records created as a result of processes prescribed in this publication are maintained in accordance with AFI 33-322, *Records Management and Information Governance Program*, and disposed of in accordance with Air Force Records Information Management System (AFRIMS) Records Disposition Schedule (RDS). The use of the name or mark of any specific manufacturer, commercial product, commodity, or service in this publication does not imply endorsement by the Air Force.

SUMMARY OF CHANGES

This publication has been substantially revised and needs to be completely reviewed. Updates include but are not limited to references, incorporation of plain language concepts in accordance with DAFMAN 90-161, movement of **Chapter 6** to **Chapter 4** for flow of document, and incorporation of previous Guidance Memorandum content.

(8FW) This document has been substantially revised and must be reviewed in its entirety. Changes include updates to match parent instructions, post-wash and documentation requirements. Authorizations for wing and squadron command tail, non-command tail and heritage paint configurations have been included.

Chapter 1—AIRCRAFT METALS TECHNOLOGY PROGRAM (2A7X1)	6
1.1. MAJCOM/A4M Responsibilities.	6
1.2. Maintenance Group Commander (MXG/CC) Responsibilities.	6

1.3.	Maintenance Squadron Commander Responsibilities.	6
1.4.	Fabrication Flight Chief Responsibilities.	6
1.5.	Aircraft Metals Technology Section Chief Responsibilities.....	7
1.6.	Additive Manufacturing.....	7
Chapter 2—NONDESTRUCTIVE INSPECTION PROGRAM (2A7X2)		9
2.1.	MAJCOM/A4M Responsibilities.	9
2.2.	MXG/CC Responsibilities.	9
2.3.	Maintenance Squadron Commander Responsibilities.	9
2.4.	NDI Section Chief Responsibilities.	9
Chapter 3—AIRCRAFT STRUCTURAL MAINTENANCE AND CORROSION CONTROL PROGRAM (2A7X3)		10
3.1.	MAJCOM/A4M Responsibilities.	10
3.2.	Wing Commander Responsibilities.	10
3.3.	Maintenance Group Commander Responsibilities.	10
3.3.	(8FW) Maintenance Group Commander Responsibilities.....	10
3.4.	Wing Corrosion Program Manager Responsibilities.	11
3.4.	(8FW) Wing Corrosion Program Manager Responsibilities.....	11
3.5.	Fabrication Flight Chief Responsibilities.	13
3.6.	Aircraft Structural Maintenance (ASM) Section Chief Responsibilities.....	14
3.7.	Wash Rack Facility Manager Responsibilities.	14
3.7.	(8FW) Wash Rack Facility Manager Responsibilities.....	14
3.8.	Wash Crew Supervisor Responsibilities.	15
3.8.	(8FW) Wash Crew Supervisor Responsibilities.	15
3.9.	Maintenance Plans, Scheduling, and Documentation (PS&D).....	16
3.10.	Aircraft Maintenance Unit (AMU)/Fighter Generation Squadron (FGS) Responsibilities.....	16
3.11.	Quality Assurance Responsibilities.	16
3.12.	AGE Flight Chief Responsibilities.	16
3.12.	(8FW) AGE Flight Chief Responsibilities.....	16
3.13.	Unit Corrosion Control Program Requirements.	18
3.13.	(8FW) Unit Corrosion Control Program Requirements.....	18
3.14.	Propulsion Flight/Element Responsibilities.....	19

Chapter 4—LOW OBSERVABLE AIRCRAFT STRUCTURAL MAINTENANCE PROGRAM (2A7X5)	20
4.1. MAJCOM/A4M Responsibilities.	20
4.2. Wing Commander Responsibilities.	20
4.3. Maintenance Group Commander Responsibilities.	20
4.4. Fabrication Flight Chief.	21
4.5. LO ASM Section Chief Responsibilities.	21
4.6. LO Quality Assurance Responsibilities.	22
4.7. Low Observable/Composite Repair Facility (LO/CRF) Manager Responsibilities.	22
4.8. LO Support Responsibilities.	23
Chapter 5—GENERAL INFORMATION	24
5.1. Aerospace Vehicle Coating and Marking Requirements.	24
5.1. (8FW) Aerospace Vehicle Coating and Marking Requirements.	24
5.2. Equipment Inspections.	25
Chapter 6—AIRCRAFT MARKING POLICY	26
6.1. Paint Schemes/Configurations and USAF Standard Markings.	26
6.2. Exterior Markings/Coatings.	26
6.2. (8FW) Exterior Markings/Coatings.	26
6.3. Aircraft Mandatory Markings (Mobility Aircraft).	26
6.4. Optional Markings (Mobility Aircraft).	27
Figure 6.1. Outstanding Unit Award.	28
Figure 6.2. Meritorious Unit Award.	28
6.5. Aircraft Mandatory Markings (Combat Aircraft).	29
6.6. Aircraft Optional Markings (Combat Aircraft).	30
6.7. Aircraft Travel Pods.	32
6.8. External Fuel Tanks.	32
6.9. Competition Aircraft.	32
6.10. Aircraft Transfer.	32
6.11. Waivers.	33
6.12. Historical Requirements.	33
6.13. Tone Down.	33
Attachment 1—GLOSSARY OF REFERENCES AND SUPPORTING INFORMATION	35
Attachment 2—AIRCRAFT MARKING SPECIFICATIONS	40

PACAFI 21-105 12 MARCH 2026	5
Attachment 3—DAILY SAS REPORTING METRIC	56
Attachment 4—SAS AUDIT METRIC	57
Attachment 5—SAS DAMAGE IMPACT DEFINITION	58
Attachment 6—LO MAINTENANCE SCHEDULE	60
Attachment 7—CANOPY TRANSPARENCY STATUS REPORTING.	61
Attachment 8—(Added-8FW) NON-COMMAND AIRCRAFT	62
Attachment 9—(Added-8FW) PAINT PLACARD	63
Attachment 10—(Added-8FW) COMMAND AIRCRAFT	64

Chapter 1

AIRCRAFT METALS TECHNOLOGY PROGRAM (2A7X1)

1.1. MAJCOM/A4M Responsibilities.

1.1.1. The designated Senior Noncommissioned Officer (SNCO) will manage the Aircraft Metals Technology (AMT) program and perform the following duties:

1.1.1.1. Manage the welder certification program in accordance with T.O. 00-25-252, *Intermediate Maintenance and Depot Level Maintenance Instructions - Aeronautical Equipment Welding*, and this instruction.

1.1.1.2. Coordinate inter/intra-command Aircraft Metals Technology TDY manning assistance requests.

1.1.1.3. Develop and coordinate command policy and procedures for Aircraft Metals Technology functions.

1.1.1.4. Coordinate inter/intra-command 2A7X1 equipment transfers.

1.1.1.5. Forecast and ensure scheduling of 2A7X1 supplemental training.

1.1.1.6. Support the Air Force Metals Technology Office by participating in equipment evaluations, field surveys, Integrated Process Teams, Product Improvement Teams, working groups, and advisory board meetings as requested.

1.1.1.7. Serve as the MAJCOM voting authority during the 2A7X1 Specialty Training Requirements Team (STRT) and Utilization and Training Workshop (U&TW).

1.2. Maintenance Group Commander (MXG/CC) Responsibilities.

1.2.1. Serve as certifying official for unit level welding examinations. The MXG/CC may delegate responsibility in writing in accordance with T.O. 00-25-252.

1.3. Maintenance Squadron Commander Responsibilities.

1.3.1. Ensure funding is available for Aircraft Metals Technology weld certification requirements at an Air Logistics Center (ALC) when local certification capabilities do not exist.

1.4. Fabrication Flight Chief Responsibilities.

1.4.1. Ensure all journeyman, craftsman or civilian equivalent welders assigned to the Aircraft Metals Technology section are Level II certified in accordance with T.O. 00-25-252 to perform welding operations in the following base metal groups: I (Carbon and Low Alloy Steel), II (Stainless Steels), III (Nickel--Base Alloys), IV (Aluminum Base Alloys), V (Magnesium--Base Alloys), VI (Titanium--Base Alloys), VII (Cobalt--Base Alloys).1.4.1.1. Level I certification may be obtained and utilized prior to achieving Level II certification if necessary to meet mission requirements.

1.4.1.1. All SrA-TSgt personnel PCSing to PAS codes KU0RFD4Z and OP0RFWNM are required to be aircraft and missile weld certified in groups 1, 2, 3, 4, 5, 6, and 7 in accordance with T.O. 00-25-252 and should be valid for at least 24 months after the transfer effective date (TED). Airmen will provide a copy of their DD Form 2757, *Welding Examination Record to outbound assignments.*"

1.4.2. Determine if welders should be qualified locally or by an ALC. If qualification will be accomplished at an ALC, ensure funding is forecasted.

1.5. Aircraft Metals Technology Section Chief Responsibilities.

1.5.1. Ensure assigned Aircraft Metals Technology personnel maintain welding certifications outlined in [paragraph 1.4.1](#).

1.5.2. Coordinate requests for an ALC or other qualified organization to qualify welders. If qualification and certification is accomplished locally, coordinate the certification requirements with the nondestructive inspection (NDI) section to ensure x-ray capability exists and required image quality indicators are present.

1.5.3. Ensure correct completion of DD Form 2757, *Welding Examination Record*, for all shop welders.

1.5.3.1. The Observing Official will be a 5 or 7-level Aircraft Metals Technology technician or civilian equivalent welder.

1.5.3.2. The Examining Official (not the NDI examiner) must be a 7-level Metals Technology technician or civilian equivalent welder and will sign and date block 18.

1.5.3.3. The Welder's Supervisor will function as the Testing Official. The Welder's Supervisor may also perform Examiner duties and date/sign block 18, when applicable.

1.5.4. Ensure journeyman are weld certified not later than 12 months following award of 5-skill level. Qualified individuals that PCS from another MAJCOM that did not have the same requirements will be certified within 6-months of assignment.

1.6. Additive Manufacturing.

1.6.1. Local Purchase Equipment. Equipment items for Additive Manufacturing (AM) process will not be purchased locally without the knowledge and approval of the AF Metals Technology Program Office (MTO), AFLCMC/EZPT-MTP, Robins AFB, GA and Command Fabrication Functional Manager.

1.6.1.1. Consumable support items and replacement parts may be purchased at any time without approval.

1.6.2. Guidance for the use of AM to build replacement parts is prescribed in AFI 63-101/20-101, *Integrated Life Cycle Management*.

1.6.3. Reference T.O. 34A-1-1, *Additive Manufacturing Qualification of Technicians, Machines and Facilities*, for AM methods and requirements for training, equipment, process controls, T.O. 34A-2-1, *Metals Additive Manufacturing General Procedures and Process Controls*, for standard AM disciplines, and T.O. 34A-3-1, *Polymers Additive Manufacturing, General Procedures and Process Controls*.

1.6.4. Additively manufactured aircraft parts require System Program Office (SPO) approval.

1.6.4.1. Approved aircraft parts will be listed in the weapon system's illustrated parts breakdown (IPB) as an alternate AM part number and appropriate Source Maintenance, and Recoverability (SMR) code (i.e., MFO or MOO), reference T.O. 00-25-195, *AF Technical Order System Source Maintenance, and Recoverability Coding of Air Force Weapons, Systems, and Equipment* and Table 1-1, AF SMR Coding Matrix.

1.6.4.2. A Technical Assistance Request (TAR) or 107 will provide authorization for limited use of non-listed substitutes (supplies, components, support equipment, etc.) to prevent work stoppages, in accordance with T.O. 00-25-107, *Maintenance Assistance*.

1.6.4.3. The Joint Engineering Data Management Information Control System (JEDMICS) is the current repository for Technical Data Packages (TDPs). Accessing <https://af-jedmics.navair.navy.mil/> and entering the appropriate drawing number (i.e., 201874532) will download the complete TDP, including the embedded build file, required to additively manufacture the part.

Chapter 2

NONDESTRUCTIVE INSPECTION PROGRAM (2A7X2)

2.1. MAJCOM/A4M Responsibilities.

2.1.1. The designated SNCO will manage the NDI program and perform the following duties:

2.1.1.1. Manage command NDI and Oil Analysis programs (OAP).

2.1.1.2. Coordinates inter/intra-command NDI TDY manning assistance requests.

2.1.1.3. Develop and coordinate command policy and procedures for NDI and OAP functions.

2.1.1.4. Coordinates inter/intra-command 2A7X2 equipment transfers.

2.1.1.5. Forecast and ensure scheduling of 2A7X2 supplemental training.

2.1.1.6. Support the Air Force NDI Office by participating in equipment evaluations, field surveys, Integrated Process Teams, Product Improvement Teams, working groups, and advisory board meetings as requested.

2.1.1.7. Serve as the MAJCOM voting authority during the 2A7X2 Specialty Training Requirements Team (STRT) and Utilization and Training Workshop (U&TW).

2.2. MXG/CC Responsibilities.

2.2.1. Ensure civilian NDI technicians are NAS 410 certified.

2.3. Maintenance Squadron Commander Responsibilities.

2.3.1. Ensure only trained 2A7X2 personnel or NAS 410 certified civilians operate NDI equipment and perform NDI assessments.

2.3.2. Ensure personnel performing NDI are certified in accordance with DAFI 21-101, *Aircraft and Equipment Maintenance Management* and NAS 410 as applicable.

2.4. NDI Section Chief Responsibilities.

2.4.1. Ensure all equipment required to perform NDI on assigned weapon systems and support equipment is authorized, available and operational.

2.4.2. Ensure NDI Quality Assurance (QA) Augmentees are properly trained in their additional duty.

2.4.2.1. NDI QA Augmentees will conduct Personal Evaluations (PE) utilizing PE checklists located on the NDI SharePoint at <https://usaf.dps.mil/teams/22399/QA/Forms/AllItems.aspx?viewpath=%2Fteams%2F22399%2FQA%2FForms%2FAllItems%2Easpx>. Upon completion of a PE, Augmentees will retain completed documentation within the NDI section until the next PE is performed on that specific method.

2.4.3. Forecasts funding for personnel to attend training courses and participate in applicable NDI conferences or working groups.

Chapter 3

AIRCRAFT STRUCTURAL MAINTENANCE AND CORROSION CONTROL PROGRAM (2A7X3)

3.1. MAJCOM/A4M Responsibilities.

3.1.1. The designated SNCO will manage the Aircraft Structural Maintenance (ASM) and Corrosion Control programs and perform the following duties:

3.1.1.1. Develop and coordinate command policy and procedures for ASM and Corrosion Control functions.

3.1.1.2. Coordinates inter/intra-command ASM TDY manning assistance requests.

3.1.1.3. Coordinates inter/intra-command 2A7X3 equipment transfers.

3.1.1.4. Forecast and ensure scheduling of 2A7X3 supplemental training.

3.1.1.5. Support the Air Force Corrosion Prevention and Control Office (AFCPCO) by participating in equipment evaluations, field surveys, Integrated Process Teams, Product Improvement Teams, working groups, and advisory board meetings as requested.

3.1.1.5.1. Coordinate with AFCPCO to ensure command corrosion survey is accomplished at a minimum of every 5 years.

3.1.1.6. Serve as the MAJCOM voting authority during the 2A7X3 Specialty Training Requirements Team (STRT) and Utilization and Training Workshop (U&TW).

3.2. Wing Commander Responsibilities.

3.2.1. Review and ensure all aircraft paint waivers and nose art requests have been routed through local Public Affairs and Wing Historians prior to submission to PACAF/A4M.

3.3. Maintenance Group Commander Responsibilities.

3.3. (8FW) Maintenance Group Commander Responsibilities.

3.3.1. Ensures adequate facilities, equipment, material, and funding are available to support a sound corrosion prevention and control program. The minimum requirements are:

3.3.1.1. Provide a facility for preparation and maintenance painting of assigned aircraft on a year-round basis in accordance with Unified Facilities Criteria (UFC) 4-211-02, *Corrosion Control and Paint Finishing Hangars*.

3.3.1.2. Ensures requirements outlined in DAFMAN 32-1084, *Standard Facility Requirements*, are met for support equipment (SE) and aircraft small parts. This capability can be incorporated in the aircraft corrosion control facility if space permits.

3.3.1.3. Ensures facility meets local, state, federal Environmental Protection Agency, and host nation requirements in conjunction with current National Emission Standards for Hazardous Air Pollutants [40 CFR Part 61 and 63].

3.3.2. Ensures adequate wash rack facilities are available to wash aircraft on a year-round basis. This requirement can be satisfied with any one or more of the following:

3.3.2.1. A specially designed corrosion control facility completely enclosed, heated with environmentally controlled ventilation and waste disposal systems, and equipped with all utilities necessary for accomplishing all facets of aircraft corrosion control.

3.3.2.2. An environmentally compliant enclosed or covered wash rack.

3.3.2.3. An outside wash rack may be used on an interim basis when weather conditions permit and when approved by Base Civil Engineer.

3.3.3. Determines organization responsible for management of aircraft wash facility.

3.3.4. Ensures frequency of wash/rinse cycles are maintained in accordance with T.O. 1-1-691, *Cleaning and Corrosion Prevention and Control, Aerospace and Non-Aerospace Equipment*, and revised as necessary based on changes in mission and location.

3.3.4.1. Report any aircraft wash overdue with official memo to MAJCOM Corrosion Program Manager. Within this memo include aircraft tail number(s), date of last wash, reason for overdue condition, and corrective action taken to prevent further occurrences.

3.3.5. Ensures Plans, Scheduling & Documentation (PS&D) section(s) schedule aircraft washes through Integrated Maintenance Data System (IMDS) or by other automated means.

3.3.5.1. **(Added-8FW)** Kunsan Air Base is located within 1.25 (2km) miles of salt water. Aircraft require a clear water rinse (Bird Bath) located on Taxiway F after the last flight of the day.

3.3.5.2. **(Added-8FW)** Waterless Wipe Down Procedures will be used when weather is too cold for bird bath usage or when the bird bath is not operable.

3.3.6. Ensures Quality Assurance (QA) adequately evaluates corrosion control programs through inspection and maintenance follow-up evaluations.

3.3.6.1. Ensures QA evaluates a minimum of 10% of all aircraft washes.

3.3.7. Appoints by letter, a Wing Corrosion Program Manager to ensure all facets of corrosion prevention are being conducted throughout the wing.

3.4. Wing Corrosion Program Manager Responsibilities.

3.4. (8FW) Wing Corrosion Program Manager Responsibilities.

3.4.1. The Wing Corrosion Manager will be a 2A773, 2A775, 2A790, or civilian equivalent.

3.4.1. **(8FW)** The Wing Corrosion Manager will be a 2A773, 2A790, or civilian equivalent.

3.4.1.1. Upon appointment, the Wing Corrosion Manager will accomplish training as prescribed in AFI 36-2650.

3.4.2. The Wing Corrosion Program Manager serves as the wing focal point for all aircraft and SE cleaning, corrosion and organic coatings related information and taskings. The Wing Corrosion Program Manager will organize, direct, and manage the wing/group corrosion management program in accordance with DAFI 21-101, DAFI 63-140, *Aircraft Structural Integrity Program and Air and Space Equipment Structural Management*, T.O. 1-1-691, T.O. 1-1-8, *Application and Removal of Organic Coatings Aerospace and Non-Aerospace Equipment*, T.O. 1-1-689-3, *Cleaning and Corrosion Control Volume III Avionics and Electronics*, T.O. 35-1-3, *Corrosion Prevention and Control, Cleaning; Painting, and Marking of USAF Support Equipment (SE)*, applicable weapon system specific –3 (structural repair manual), -23 (corrosion prevention and control manual), and this instruction.

3.4.3. Before reassignment or retirement, the Wing Corrosion Manager will ensure their successor is appointed early enough prior to DEROS (not later than 60 days long tour/30 days short tour) to provide an effective turnover of the corrosion program. The outgoing corrosion manager must confer with the Fabrication Flight Chief and ASM supervisors to identify a replacement. A copy of the new appointment memo will be sent to PACAF/A4M, Command Fabrication Functional/Corrosion Manager, within 60 days of the appointment.

3.4.4. Ensures creation of a wing supplement to this instruction to include, but not limited to the following:

3.4.4.1. MAJCOM, NAF, Wing, OG, and Fighter/Bomber Squadron commander aircraft designation and marking requirements of identified aircraft.

3.4.4.1.1. **(Added-8FW)** Command Aircraft designation and markings are located in **Attachment 10** of this publication.

3.4.4.2. Local unit marking requirements e.g., tail stripes, crew names, etc.

3.4.4.2.1. **(Added-8FW)** Non-Command Aircraft markings and aircraft tail stripes will be applied IAW **Attachment 8** of this publication.

3.4.4.2.2. **(Added-8FW)** Pilot and Crew Chief names will be 1 3/4" high, flat black. Standard aircraft will be Military Block font, the FW, OG, and FS commander's aircraft will be Brush Script font.

3.4.4.3. Aircraft paint identification placard size, shape, and information requirements.

3.4.4.3.1. **(Added-8FW)** Aircraft paint identification placard will be applied IAW **Attachment 9** of this publication.

3.4.5. Ensures corrosion inspections are accomplished during each phase/periodic inspection for aircraft and equipment assigned.

3.4.6. Ensures corrosion prevention and treatment procedures are performed within technical order requirements.

3.4.6.1. In the event there are no weapons system specific post wash corrosion inspection requirements, units must establish local requirements.

3.4.6.2. **(Added-8FW)** The post wash corrosion inspection will be accomplished IAW LCL-8MXG- 023, *Post-Wash Corrosion Inspection Procedures*.

3.4.7. Ensure only Qualified Product List (QPL) and/or the Qualified Product Database (QPD) authorized wash agents are utilized for overall and spot washes. Use of unapproved commercial or household/janitorial cleaners is strictly prohibited.

3.4.8. In conjunction with the local Supply/Hazmart pharmacy, ensure only products from QPLs/QPDs approved for aircraft/aerospace equipment are being used.

3.4.9. Ensures required equipment is obtained for an efficient and effective corrosion prevention and control program.

3.4.10. Ensures corrosion related training courses (initial and refresher) are administered as intended by the MAJCOM or AFI. Local corrosion training programs may be initiated as deemed necessary due to local corrosive environment, weapon system corrosion susceptibility and forward operating environments.

3.4.10.1. **(Added-8FW)** All maintenance personnel that come in contact with aircraft or support equipment shall receive initial corrosion prevention and identification training within 90 days of assignment during Mission Orientation.

3.4.10.2. **(Added-8FW)** All 2A7X3 personnel are exempt from this training requirement.

3.4.11. Determines the adequacy of corrosion control work cards for assigned equipment based on mission and location.

3.4.12. At units utilizing wash contractors, the Wing Corrosion Manager must be thoroughly familiar with contract specifications, applicable technical orders, and inspection/acceptance criteria. The wing corrosion manager should be included in the coordination process of all new/updated wash contracts.

3.4.13. Maintain records of all approved waivers with full length color photographs, score sheets of maintained aircraft, and wing corrosion manager appointment letter.

3.4.14. Establish and chair a local corrosion prevention working group to formalize the wing corrosion management program. Working groups may meet as frequently as necessary to maintain an effective program but will meet at least annually. This working group should meet approximately 90 days prior to the next scheduled applicable weapons system Corrosion Prevention Advisory Board (CPAB) to formalize action items. Minutes will be published and are recommended to be maintained at least 3 calendar years for continuity purposes.

3.4.14.1. As a minimum, membership will include the unit corrosion manager, flight line (owning unit) maintenance supervisors, PS&D personnel, ASM supervisors, Aerospace Ground Equipment (AGE) supervisors, and appropriate QA representatives.

3.4.14.2. Submit CPAB action items to the Command Fabrication Functional/Corrosion Manager. Action items may be submitted throughout the year and must focus on structural integrity, extended service life, and improved repair techniques for the weapon system.

3.4.15. Serve as wing corrosion program Point of Contact (POC) for all outside agencies.

3.5. Fabrication Flight Chief Responsibilities.

3.5.1. Recommend a Wing Corrosion Manager to the MXG/CC.

3.5.1.1. Forecast funding for wing corrosion control manager attendance at Corrosion Control Working Groups, CPABs, Aircraft Structural Integrity Programs (ASIPs), and other pertinent meetings as required. Ensure Fabrication representation for ASIP and CPAB conferences in person or via telecom.

3.6. Aircraft Structural Maintenance (ASM) Section Chief Responsibilities.

3.6.1. Ensures no other maintenance is accomplished on aircraft or equipment within environmentally controlled/cordoned off areas during corrosion prevention treatment utilizing hazardous/toxic materials requiring the use of specialized personal protective equipment.

3.6.2. Submits CPAB agenda items to MAJCOM ASM Manager.

3.6.3. Requests depot assistance in accordance with T.O. 00-25-107 through the MAJCOM weapon system manager with an information copy to PACAF/A4M when corrosion treatment/repairs exceed technical order limits.

3.6.4. Ensures Bioenvironmental Engineering conducts initial baseline comprehensive evaluations and provide annual follow-ups to determine adequacy of work center controls for occupational hazards. Briefs all structural personnel of survey results and maintains records of this survey in the work center.

3.6.5. Appoints a qualified 2A753/2A755 or higher technician, or civilian equivalent, as the Wash Rack Facility Manager. This manager will ensure proper cleaning materials, equipment, and supplies are maintained in accordance with applicable technical orders, DAFI 21-101 and PACAF supplements.

3.6.6. Ensure a corrosion control facility housekeeping program is developed and followed in accordance with DAFI 21-101.

3.7. Wash Rack Facility Manager Responsibilities.

3.7. (8FW) Wash Rack Facility Manager Responsibilities.

3.7.1. Ensures the required number and size of fire extinguishers are available and serviceable.

3.7.2. Ensures grounding points are inspected and approved in accordance with T.O. 00-25-172, *Ground Servicing of Aircraft and Static Grounding Bonding*.

3.7.3. Ensure fall protection equipment is available, used and maintained in accordance with DAFMAN 91-203, *Air Force Occupational Safety, Fire, and Health Standards*, to allow coverage of all surface areas of aircraft during washing operations.

3.7.4. Ensures aircraft wash rack has cleaners identified in weapon system specific technical data. When cleaning products are not listed in weapon system specific technical data, ensure at least two types of approved cleaners in accordance with T.O. 1-1-691 are properly used, to include proper mix ratio and the correct cleaner for each area cleaned.

3.7.5. Ensures wash rack facility and surrounding area is kept clean and properly maintained.

3.7.6. Procure personal protective equipment used during wash process. Maintains wash rack facilities and equipment in serviceable condition (e.g., water hoses, pumps, air hoses, powered wash equipment, SE, Personal Protective Equipment (PPE), etc.). This may not apply to units utilizing wash contracts.

3.7.6.1. **(Added-8FW)** 8 MXS personnel will provide equipment, supplies and the wash facility. The wash rack has three scheduled wash time slots (0800-1100, 1115-1400, 1415-1700) available during each duty day of operation. Request to use wash rack facility during off shifts and/or weekends will be coordinated with the 8 MXS Production Office. Aircraft deployed to Kunsan AB will be washed IAW the same guidance as assigned aircraft due to the highly corrosive environment and will be scheduled through the weekly Shared Resource meeting.

3.7.6.2. **(Added-8FW)** In the event that a wash is requested outside of the normal wash time slots, it is the responsibility of the owning FGS to wash and clean both the aircraft and equipment. The intent is that the responsibilities listed in para 3.10 of PACAFI21-105 area of the Fighter Generation Squadron responsibilities are carried out.

3.7.7. **(Added-8FW)** After the wash is completed, the post wash corrosion inspection and the aircraft paint score will be accomplished IAW LCL- 8MXG-023 by two 2A7X3 personnel. These inspections will be input into a locally devised paint tracker (living document on Q: drive) and the F-16 Common Inspection Reporting Engine (CIRE) database.

3.8. Wash Crew Supervisor Responsibilities.

3.8. (8FW) Wash Crew Supervisor Responsibilities.

3.8.1. Provides daily safety briefings explaining hazards associated with wash rack operations.

3.8.1.1. **(Added-8FW)** Aircraft must have a completed Hangaring Checklist (Locally approved Quality Assurance checklist) and Job Standard (JST) 80003/35004 loaded prior to entry into wash facility. The wash crew supervisor will also complete a Wash Crew Supervisor Checklist (Locally approved Quality Assurance checklist) and conduct Wash Rack Safety Procedures Briefing using (Locally approved Quality Assurance checklist) and ensure that all wash crew members annotate the form.

3.8.2. Ensure aircraft wash crews are task trained and qualified. All training and qualifications must be documented in the personnel's training records.

3.8.3. Ensure proper safety equipment, PPE and cleaning materials are serviceable and properly used in accordance with DAFMAN 91-203.

3.8.4. Enters the requirement for wash, performs cleanliness inspection, signs the wash completion and enters the lubrication requirement in the AFTO Form 781A, *Maintenance Discrepancy and Work Document* or other electronic form of documentation.

3.8.4.1. **(Added-8FW)** After the wash is completed and PRIOR to the aircraft leaving the wash facility, the post wash corrosion inspection and the aircraft paint score will be accomplished IAW LCL-8MXG-023 by two 2A7X3 personnel.

3.8.5. Ensure that fall protection is serviceable and inspected prior to use in accordance with DAFMAN 91-203.

3.8.5.1. **(Added-8FW)** The wash rack uses passive fall protection in the form of maintenance stands. Masking and removing covers and tape is the only time that personnel are allowed on top of the aircraft in the wash rack. The aircraft must be dry for personnel to be on top of the aircraft.

3.8.6. Ensure aircraft are properly grounded as required in accordance with TO 00-25-172 and weapon system-specific technical data.

3.8.7. Inspects all wash rack equipment for serviceability, i.e., water hoses, pumps, air hoses, powered wash equipment, support equipment, etc. prior to use.

3.8.8. Ensure wash rack facility, surrounding area and equipment is clean and equipment is properly stored before and after use.

3.9. Maintenance Plans, Scheduling, and Documentation (PS&D).

3.9.1. Ensure frequency-of-cleaning/wash cycles are established for assigned aircraft to maximize corrosion prevention. Monitors aircraft wash schedules to eliminate overdue washes. Unit wash cycles will not exceed the maximum wash cycles listed in T.O. 1-1- 691, unless coordinated and approved IAW T.O. 00-25-107 or other published T.O. guidance.

3.10. Aircraft Maintenance Unit (AMU)/Fighter Generation Squadron (FGS) Responsibilities.

3.10.1. Appoint an experienced/qualified wash crew supervisor.

3.10.2. Ensure trained wash crew supervisors are present throughout the duration of aircraft washes.

3.10.3. Provide a task trained, appropriately equipped and qualified aircraft wash crew.

3.10.4. The Wing Corrosion Manager and owning unit supervisors/managers train and qualify personnel on aircraft washing and cleaning. Training will be locally developed based on environmental conditions and specific MDS assigned.

3.10.5. The wash supervisor ensures the facility and equipment is cleaned and properly stored at completion of each wash.

3.11. Quality Assurance Responsibilities.

3.11.1. Evaluate at least 10% of all aircraft washes and at least 10% of all AGE washes for compliance with applicable technical data.

3.11.2. Evaluate the quality of 10% of all aircraft and equipment corrosion inspections.

3.11.3. Periodically review wash rack cleaning agents for QPL/QPD compliance.

3.11.4. Contracting Officer Representative (COR) for aircraft washes will evaluate at least 10% of all aircraft washes. COR should maintain a file of discrepancies for consideration during contract rewrites. If a current contract specifies a different level of inspection than that specified herein, the contract will take precedence. Future contracts will incorporate the 10% inspection rate as a minimum.

3.11.5. The COR will use locally developed aircraft wash cleanliness forms and checklists to evaluate contract wash compliance.

3.11.6. Contract washes will be signed off by authorized personnel.

3.12. AGE Flight Chief Responsibilities.

3.12. (8FW) AGE Flight Chief Responsibilities.

3.12.1. Ensure AGE work center personnel attend corrosion training.

3.12.2. The corrosion manager, in concert with the AGE supervisor and unit maintenance training manager, will develop a corrosion prevention and control training curriculum. The training is available at <https://367trss.cce.af.mil>.

3.12.2.1. **(Added-8FW)** All assigned AGE will have its paint coating scored at least once every two years. The completion date and paint scores will be documented by the AGE scheduler on a locally devised spreadsheet (living document on Q: drive).

3.12.3. The corrosion manager, in conjunction with the AGE supervisor, will determine the training interval. The training interval will be at least annually.

3.12.4. Establish and enforce an effective corrosion program on assigned AGE and SE.

3.12.5. Aircraft structural maintenance and AGE supervisors determine repainting requirements.

3.12.5.1. Complete over coating of equipment is accomplished on an as needed basis. AGE will not be over coated solely for cosmetic purposes unless the AGE Flight Chief and Fabrication Flight Chief determine it is required. Equipment will be prioritized based on “worst is first” unless downing the equipment would affect AGE Flight mission essential levels.

3.12.6. Owing work center personnel may treat small chips in the paint with Corrosion Prevention Compounds (CPC) listed in T.O. 35-1-3. For more permanent repairs of small, chipped areas, use authorized coating systems that are contained in items such as but not limited to: SEMPENS, Preval compressed air spray packs, Clip-Pacs, Brush and Roller, or AkzoNobel Spray 2 Fix aerosol can. Larger areas will be treated by the aircraft structural maintenance work center or if applicable, contracted sources.

3.12.6.1. Units will familiarize themselves with AGE painting materials and processes in accordance with T.O. 35-1-3 prior to awarding off-base contracts to get AGE painted. Units will verify specifications for primer and topcoat, and color number requirements and ensure that these are addressed in the contract.

3.12.7. AGE SE will be painted in accordance with T.O. 35-1-3.

3.12.7.1. **(Added-8FW)** Fabrication Flight provides local policy for the number of AGE units for corrosion treatment per week/month, weekly coordination, etc. (reference Aerospace Ground Equipment Corrosion Control/Paint Plan Memorandum filed with AGE and Fabrication Flight Chiefs)

3.12.7.2. **(Added-8FW)** The AGE flight is responsible for marking all equipment. Uniformity will be maintained to ensure a professional looking fleet.

3.12.8. Ensure an automated system is used to schedule and document AGE painting. A historical entry will be made into the automated system upon complete repainting of equipment.

3.12.9. Enforce the proper use of approved cleaning compounds in accordance with T.O. 35-1-3 and the QPL or QPD.

3.13. Unit Corrosion Control Program Requirements.

3.13. (8FW) Unit Corrosion Control Program Requirements.

3.13.1. Owning activities will wash and clean their aircraft and support equipment.

3.13.2. Wing Corrosion Program Manager and/or ASM personnel will assist the owning activities in their corrosion prevention efforts by accomplishing scheduled corrosion inspections on aircraft, support and test equipment.

3.13.3. Only Aircraft Structural Maintenance personnel will perform aircraft inspection work cards specified for accomplishment by Aircraft Structural Maintenance in the -6 T.O. or within ALIS on the F-35. All maintenance personnel, regardless of Air Force Specialty Code (AFSC), will examine each part removed and inspect the inside of all exposed areas for corrosion. When corrosion discrepancies are discovered affecting aircraft structural integrity, safety of flight/operation, or are beyond the using organization's capability to evaluate/repair, an aircraft structural maintenance specialist will be requested.

3.13.4. Maintenance personnel who remove/install aircraft panels and doors must ensure seals are serviceable and sealant applied to panels and fasteners as specified in applicable aircraft technical orders.

3.13.5. Maintenance personnel will report all corrosion deficiencies through applicable MIS in accordance with 00-20 series technical orders or ALIS. Accurate documentation of maintenance actions in support of the corrosion control program is essential to support future manning, equipment requirements, training, and parts/material procurement requirements.

3.13.5.1. **C-130 units:** NDI, ASM and QA personnel will use the Inspection, Crack/Corrosion and Repair Reporting (ICARR-3D) software to make inputs to the Automated Inspection, Repair, Corrosion, and Aircraft Tracking (AIRCAT) database for all NDI directed by technical orders; cracks and corrosion exceeding blending limits of Structural Repair Manual; and structural repairs in accordance with 1C-130A-6/1C-130J-6. Corrosion within blending limits of the Structural Repair Manual will not be documented. This is an Aircraft Structural Integrity Program (ASIP) requirement. See <https://c130aircat.robins.af.mil> for program instructions and information on ICARR-3D. Report all C-130 discrepancies in ICARR-3D.

3.13.5.2. **(Added-8FW)** CIRE Reporting (F-16 users). NDI, ASM and QA personnel shall use the Common Inspection Reporting Engine (CIRE) software to make inputs for all NDI directed by technical orders; cracks and corrosion exceeding blending limits of Structural Repair Manual; and structural repairs IAW 1F-16C-6. Corrosion within blending limits of the Structural Repair Manual shall not be documented. This is an Aircraft Structural Integrity Program (ASIP) requirement. See <https://asimis.tinker.af.mil/f16/> for program instructions and information on CIRE reporting for all F-16 discrepancies.

3.13.6. **(Added-8FW)** All aircraft sanding and paint/coating repairs will only be accomplished in the approved corrosion control facility (Building 2820). All requests must first be coordinated through the Wing Corrosion Manager.

3.13.7. **(Added-8FW)** 8 MOF Plans and Scheduling will coordinate all aircraft paint requirements through the Wing Corrosion Manager during the weekly Plans and Scheduling meeting based on a “worst-is-first” scenario and prioritize coating repairs based on mission requirements.

3.13.8. **(Added-8FW)** Aircraft components (Pods, Tanks, AME, etc.) requiring painting will be scheduled for treatment with the Corrosion Control section. Coordination between the Wing Corrosion Manager and all component owning agencies will be addressed prior to receiving any units.

3.13.8.1. **(Added-8FW)** Corrosion Control is responsible for marking these components after full or partial painting. The procedures and guidelines in the applicable component’s T.O. and AFI’s will be used. Owing agencies will provide applicable technical data if corrosion personnel do not have access to the technical data. Owing organizations will ensure there are no unauthorized markings applied to components.

3.13.9. **(Added-8FW)** Munitions Equipment.

3.13.9.1. **(Added-8FW)** Munitions Equipment (Missile Bodies, Trailers, etc.) requiring painting will be scheduled for treatment with the Corrosion Control section. Coordination between the Wing Corrosion Manager and all component owning agencies will be addressed prior to receiving any units.

3.13.9.2. **(Added-8FW)** Corrosion treatment of munitions support equipment will be accomplished by qualified section personnel with corrosion personnel assistance. Munitions trailers will be broken down by Aircraft Munitions Maintenance Organization (AMMO), cleaned, then AMMO personnel will take it to Building 2820 for corrosion treatment.

3.13.9.3. **(Added-8FW)** The Equipment Maintenance Element is responsible for providing all stencil and decal material. Each element within the munitions flight will support their equipment.

3.14. Propulsion Flight/Element Responsibilities.

3.14.1. As required, establish a statement of work with the Fabrication Flight Chief defining the local repair process. Ensure personnel are trained in the tasks required to complete composite repairs in the T.O. 1-1-690, *General Advanced Composite Repair Processes Manual*, and applicable technical data.

3.14.2. As required, establish a maintenance plan to ensure work being accomplished is safe and has bioenvironmental approval. Follow Unified Facilities Criteria (UFC) 4-211-02, *Aircraft Corrosion and Paint Facilities*, guidance for proper exposure controls to personnel.

Chapter 4

LOW OBSERVABLE AIRCRAFT STRUCTURAL MAINTENANCE PROGRAM (2A7X5)

4.1. MAJCOM/A4M Responsibilities.

- 4.1.1. Designate a SNCO to perform the following duties:
 - 4.1.1.1. Manage command Low Observable (LO) programs
 - 4.1.1.2. Coordinates inter/intra-command LO TDY manning assistance requests.
 - 4.1.1.3. Develop and coordinate command policy and procedures for LO functions.
 - 4.1.1.4. Coordinates inter/intra-command 2A7X5 equipment transfers.
 - 4.1.1.5. Forecast and ensure scheduling of 2A7X5 supplemental training.
 - 4.1.1.6. Represent MAJCOM for all applicable 2A7X5 issues at LO conferences and meetings.
 - 4.1.1.7. Serve as the MAJCOM voting authority during the 2A7X5 Specialty Training Requirements Team (STRT) and Utilization and Training Workshop (U&TW).

4.2. Wing Commander Responsibilities.

- 4.2.1. Ensures funding is available to support annual radar cross section (RCS) flight test requirements.

4.3. Maintenance Group Commander Responsibilities.

- 4.3.1. Establish and maintain an effective low observables maintenance program.
 - 4.3.1.1. Ensure scheduling of aircraft downtime for LO reduction at the appropriate time based on overall fleet health and/or SAS/LOHAS damage priority screen.
- 4.3.2. Appoint a fully qualified 2A775 technician or civilian equivalent to QA who is solely focused on LO maintenance processes. Requirement is 1 per AMU/FGS.
 - 4.3.2.1. LO QA personnel must possess a valid program security clearance in order to fully perform QA duties.
- 4.3.3. Ensure PS&D sections schedule F-22 and F-35 annual aircraft audits.
- 4.3.4. Monitor annual LO F-22 and F-35 audit trends to ensure fleet LO mission capable status is accurately documented and reported.
- 4.3.5. Support RCS test events with required aircraft and maintenance personnel. This includes Signature Management Program (SMP) flight testing, Acceptance Test Facility (turntable) revisits and Repair Verification Radar testing.
 - 4.3.5.1. Units must confirm aircraft will support SMP at least 90 days prior to event.
- 4.3.6. Approval authority for flying aircraft in Aero Only configuration; ensures procedures contained in F-22A TOD and F-35 Interim Maintenance Procedure F35-IMP-A0110510105-960A-A are followed.

4.3.7. Work closely with the OG/CC to balance flying requirements with maintenance capability to prevent an uncontrollable LO backlog.

4.3.8. Ensure all personnel who directly perform maintenance on F-22 and F-35 aircraft complete annual LO awareness, panel handling training through the Maintenance Training Flight (MTF).

4.3.9. Ensure hot wash/lessons learned information is documented for each Theater Security Package (TSP) deployment and shared with like units/MAJCOMs.

4.4. Fabrication Flight Chief.

4.4.1. Use LO Field Training Detachment (FTD) training availability/capacity at every opportunity to elevate capability over the long term and provide recommended changes as required.

4.4.2. Forecast funding to attend and participate in applicable LO meetings, CPABs and other structural related programs/meetings.

4.4.3. Ensure all personnel exposed to LO work environments comply with OSHA, AF, MAJCOM, and wing policies on hygiene standards and preventing contamination of common areas outside of the direct work environment.

4.4.4. Report fleet LO mission capable status (**Attachment 5**) to the applicable MAJCOM weapon system team daily. Fleet SAS/LOHAS average reported must not include non-possessed aircraft.

4.5. LO ASM Section Chief Responsibilities.

4.5.1. Maintain a comprehensive training plan ensuring assigned personnel develop and maintain proficiency in all facets of LO finishes, metallic structures, composite repair, corrosion control, signature assessment, and electronic maintenance information system data entry commensurate with awarded skill level.

4.5.2. Ensure LO ASM personnel receive pre-placement, special purpose, periodic and termination occupational physicals as deemed necessary by local Medical Group Aero Medical Services in accordance with AFI 48-145, *Occupational and Environmental Health Program*.

4.5.3. Ensure LO ASM personnel provide updated information required to obtain and retain special program security access to the unit or group security manager in a timely manner.

4.5.4. Ensure an LO composite repair facility security training plan is developed with initial and annual training to be used for each individual working within the section.

4.5.5. Develop a dedicated LO OML inspection crew to maintain inspection consistency and inspector proficiency.

4.5.5.1. Establish an OML team rotation plan to ensure all LO personnel remain proficient.

4.5.6. F-22s Request depot assistance in accordance with T.O. 00-25-107 through the ACC weapon system manager. F-35s Request depot assistance through ALIS utilizing the CRM process.

4.5.7. Ensure accuracy of LO mission capable status documentation and reporting **Attachment 3/Attachment 7**. This includes establishment of a SAS data integrity team to ensure data is routinely cross checked for accuracy.

4.5.8. Appoint an LO production supervisor to manage scheduling and workload, **Attachment 6**, on each shift.

4.5.9. Ensure no other maintenance is accomplished on the aircraft, equipment, or within the environmentally controlled/cordoned-off areas during corrosion prevention/treatment or coatings restoration when hazardous/toxic materials are in use requiring the use of specialized personal protective equipment.

4.5.10. Ensure deficiency reports (DR) are accomplished as necessary in accordance with T.O. 00-35D-54, *USAF Deficiency Reporting, Investigation, and Resolution*.

4.6. LO Quality Assurance Responsibilities.

4.6.1. Establish a comprehensive inspection program to ensure the integrity of LO maintenance and SAS documentation associated with mission capable status reporting. This includes frequent personal evaluations of aircraft OML inspections, SAS documentation and LO repair processes in accordance with technical order guidance.

4.6.2. Identify/report all LO training and process deficiencies to the Fabrication Flight Chief.

4.6.3. Include periodic participation in annual aircraft LO audit inspections, **Attachment 4**, as part of Maintenance Standardization Evaluation Program.

4.6.4. Update Wing leadership on LO maintenance quality and potential improvement areas during the Health of Fleet (HoF) brief if applicable.

4.7. Low Observable/Composite Repair Facility (LO/CRF) Manager Responsibilities.

4.7.1. Reporting facility operation deficiencies such as the Heating, Ventilation and Air Conditioning (HVAC) systems, compressed and breathing air systems, electrical systems, plumbing and drainage systems within the LO/CRF and on assigned real property of the LO/CRF.

4.7.2. Perform tasks related to the overall management and operations of the LO/CRF, including energy management and equipment inventory.

4.7.3. Inspect facility for safety and maintenance issues that require repair as required by technical orders and Air Force instructions. Ensure all measures are taken to maintain security accreditation of facility as required.

4.7.4. Submit facility work orders through Civil Engineer (CE) Customer Service. In cases of established/approved contract maintenance for facilities, contact contractor for emergency or out of cycle maintenance. This includes warranty repairs and required maintenance.

4.7.4.1. Track the completion of contractor and CE work orders. Maintain record of all work to include response time and time required until satisfactory completion of work.

4.7.4.2. Perform escort duties or provide escorts as needed for contract maintenance personnel within special access areas of the LO/CRF.

4.8. LO Support Responsibilities.

4.8.1. Stocks supplies, consumables, tools, and equipment to support LO aircraft inspection, maintenance, and surface treatment. Processes supply requests, tracks MICAP due-outs, monitors bench stock, conducts bench stock and adjusted stock level reviews, and operates tool storage areas. In addition, the Support Section NCOIC will ensure a section due-out release point and holding bins are established. Supports CTK/Special tools, E- tools and test equipment.

4.8.2. Maintain bench and operating stocks.

4.8.3. Control and maintain TMDE in accordance with T.O. 33-1-27, *Maintenance Support of Precision Measurement Equipment*, T.O. 33K-1-100-2-CD-1, *TMDE Calibration Interval Technical Order and Work Unit Code Reference Guide*; T.O. 00-20-14, *Air Force Metrology and Calibration Program* and other applicable technical directives concerning the use, care, handling, transportation, and calibration of TMDE owned by the section.

4.8.4. Provide monthly critical support equipment status update to squadron supervision.

4.8.5. Maintain QRL as needed and provide it to technicians.

4.8.6. Track and process DIFM assets.

4.8.7. Manage reusable containers in accordance with DAFI 24-602 Volume 2, *Cargo Movement*, and T.O. 00-20-3, *Maintenance Processing of Repairable Property and the Repair Cycle Asset Control System*.

4.8.8. Manage section's hazardous material (HAZMAT) program.

4.8.8.1. Organize and coordinate effective shipping and staging operation.

4.8.8.2. Issue/turn in materials to/from workers using the tool accountability system (TAS).

4.8.8.3. Maintain records and documentation actions to ensure compliance with applicable directives.

Chapter 5

GENERAL INFORMATION

5.1. Aerospace Vehicle Coating and Marking Requirements.

5.1. (8FW) Aerospace Vehicle Coating and Marking Requirements.

5.1.1. Paint schemes/configurations and USAF standard aircraft markings will be applied in accordance with T.O. 1-1-8 and the applicable aircraft technical order.

5.1.2. Coating System Scoring and Maintenance. All units will score aircraft coating systems to determine frequency of topcoat application.

5.1.2.1. All aircraft coating systems except F-22 and F-35 will be evaluated/rated every 6 months for appearance/coating system integrity using applicable technical data or a locally developed system.

5.1.2.2. The exterior of aircraft must be clean prior to paint scoring.

5.1.2.3. **(Added-8FW)** The 8 FW Corrosion Manager will maintain the results each time an aircraft is scored. The completion date and paint scores will be documented on a locally devised spreadsheet (living document on Q: drive) and input into the F-16 CIRE website. By 1200 hours on the day prior to the Shared Resources Meeting, the Wing Corrosion Manager will send the spreadsheet to Plans and Scheduling to update the weekly slides.

5.1.3. Supervisors will use ratings to determine corrosion treatment/paint scheduling priority. **(T-2)**

5.1.3.1. All aircraft painting will be scheduled on a worst first basis to maintain coating system integrity and aircraft appearance.

5.1.4. Units are required to adopt maintenance-painting techniques (i.e., spot painting and sectionalized painting as stated in T.O. 1-1-8) to maintain aircraft corrosion protection and appearance between overcoats.

5.1.4.1. **(Added-8FW)** All aircraft sanding and painting operations will ONLY be performed in the Corrosion Control Facility. This will be scheduled during Shared Resource meetings.

5.1.4.2. **(Added-8FW)** Aircraft scheduled for touch up/full paint must be washed no earlier than one duty day prior to scheduled paint and towed directly into Corrosion Control Facility.

5.1.4.3. **(Added-8FW)** All fuel tanks will be empty and purged PRIOR to being input into Corrosion.

5.1.4.4. **(Added-8FW)** Corrosion Control facility is not manned during exercises. Therefore, aircraft will not be scheduled for paint during exercises. In addition, aircraft will not normally be scheduled for a full scuff sand and overcoat during any week with holidays or down days. Deviations need to be coordinated with the Wing Corrosion Program Manager.

5.1.4.5. **(Added-8FW)** One complete set of uninstalled external fuel tanks may be included during a full scuff sand and overcoat. The tanks must be drained/purged of fuel and cleaned PRIOR to coming into the corrosion facility. It is the owning FGS's responsibility to hang fuel tanks on the paint stands upon delivery.

5.1.4.6. **(Added-8FW)** Aircraft configuration for a full scuff sand and overcoat will have JST 80012/35012 loaded and configured as follows:

5.1.4.6.1. **(Added-8FW)** All pylons, tanks, and pod fittings will be removed from the aircraft.

5.1.4.6.2. **(Added-8FW)** All fuel tanks will be empty and purged.

5.1.5. Fully over coated aircraft will be documented in applicable MIS and the individual aircraft AFTO Form 95, *Significant Historical Data*, for tracking purposes.

5.1.5.1. **(Added-8FW)** Any aircraft full paint will require aircraft weight and balance IAW T.O. 1F-16CM-5-2, *Loading Data*, para. 2.1.. Wing Corrosion Manager will ensure applicable aircraft forms are annotated after full paint and QA is notified. Aircraft paint touch ups/inlet lip repairs do not require weight and balance.

5.1.6. Units with large aircraft should rely on spot maintenance painting and sectionalized painting between depot cycles to maintain the coating system integrity.

5.2. Equipment Inspections.

5.2.1. All sections within the Fabrication Flight are authorized (not required) to utilize Process Control Automated Management System (PCAMS). It can be utilized to track maintenance, inspections, and discrepancies for shop equipment. PCAMS can be found on the NDI SharePoint site at <https://usaf.dps.mil/teams/22399/SitePages/Home.aspx>.

Chapter 6

AIRCRAFT MARKING POLICY

6.1. Paint Schemes/Configurations and USAF Standard Markings.

6.1.1. Paint schemes/configurations and USAF standard markings will be applied in accordance with the applicable aircraft technical order, aircraft drawings, T.O. 1-1-8, and this instruction.

6.2. Exterior Markings/Coatings.

6.2. (8FW) Exterior Markings/Coatings.

6.2.1. All aircraft markings will be maintained intact, legible, and distinct in color (not faded). Command standardization of markings by MDS is of primary concern. **(T-2)**

6.2.2. All exterior aircraft markings must match the gloss level of the basecoat. No approved diffuse clear coats are available; low-gloss materials must be used for all markings on aircraft with lusterless paint schemes. **(T-2)**

6.2.3. Operational markings and structural coating/corrosion maintenance will take precedence over cosmetic refinements; markings, such as nose art, tail flash, and Dedicated Crew Chief (DCC) names should be considered lowest priority work. **(T-2)**

6.2.4. When large sections of an aircraft are repainted (i.e., entire wing, fuselage, or empennage) they will be documented in applicable MIS and the individual AFTO Form 95. **(T-2)**

6.2.5. Review applicable weapon system technical data for weight and balance (W&B) requirements.

6.2.6. **Stenciling.** Markings may be applied using stencils. Refer to T.O. 1-1-8 to determine the compatibility of stenciling paints, paint finishes and decal applications.

6.2.6.1. **(Added-8FW)** Vinyl lettering will be used to apply name tapes on assigned aircraft.

6.2.6.1.1. **(Added-8FW)** The condition of the name tapes will be inspected prior to each aircraft's 30-day wash by the owning FGS. If deteriorated or peeling, the FGS will load a job in IMDS/aircraft forms if one has not already been established. FGS will create a Work Center Event (WCE) to the Corrosion section.

6.3. Aircraft Mandatory Markings (Mobility Aircraft).

6.3.1. Letters and Numerals. Unless specified in other guidance, these markings may be applied using any style letter/numeral (font) deemed appropriate by the Wing Commander. Size and location must remain standardized for all wing-assigned aircraft.

6.3.2. Standard Air Force Markings. Mandatory markings will be applied in accordance with T.O. 1-1-8, weapon system drawings, if applicable, weapon system specific T.O., and the applicable table in this instruction. **Attachment 2** list the size, location, and color of markings by aircraft type. For identification, placement, and color of mandatory markings other than those identified in this instruction, refer to the weapon system technical orders and system drawings.

6.3.3. US Flag. Paint may be used only when high-quality templates or silk-screen processes are used. Flag decals can be obtained by going online to the Defense Logistics Agency Document Services website at <https://www.dso.documentservices.dla.mil>. Customer support may be reached at 1-866-736-7010. Flag decals may be purchased with the International Merchant Purchasing Authorization Card. There is no form number or part number for flag decals; therefore a “short title” should be used. The short title is either “21-inch by 40-inch Matte Finish Flag Decal” or “24-inch by 48-inch Matte Finish Flag Decal,” as applicable. Flag decals have a one-year shelf life. For best results, use 3M edge sealer part number 4150 (designed for polyester decal films).

6.4. Optional Markings (Mobility Aircraft).

6.4.1. When used, the following optional markings will be applied in accordance with the applicable tables in this instruction. Changes/standardization of optional markings may be done on an attrition basis to minimize workload, aircraft availability, and environmental impact. **Attachment 2** list the size, location and color of markings by aircraft type. **(T-2)**

6.4.2. Approval Authority for Optional Markings. Final approval for all permanent optional markings will come from the Fabrication Functional Manager and PACAF/A4M. All levels of supervision have the responsibility to review the markings for tastefulness, appropriateness, and adherence to copyright laws.

6.4.2.1. Nose Art: E-mail request with WG/CC approval, local Public Affairs and Wing Historian coordination, justification, the design, and tail number to pacaf.a4mv3@us.af.mil for TMT coordination and PACAF/A4M approval.

6.4.3. Nose Art. Nose art is authorized on one aircraft per flying squadron, plus the wing pride aircraft. Additionally, one aircraft per wing may have the “Let’s Roll” graphic applied as nose art (not to exceed three feet in diameter); it may be on one of the above aircraft, or in addition to the above aircraft. Nose art is not permitted on any aircraft flying missions where local populations may consider it sensitive or offensive. Art will reflect a theme of civic and community pride, be distinctive, symbolic, and designed and maintained to the highest quality standards. Positioning of nose art is at the discretion of the Wing Commander; however, it must be forward of the wing leading edge and not interfere with any mandatory markings. Nose art should be approximately two-thirds the size of the fuselage national star insignia, not to exceed three feet in diameter. All nose art applied to wing aircraft will be of standard size and location. Nose art and tail flash designs must be approved prior to installation.

6.4.3.1. On aircraft with lusterless paint schemes, nose art and tail flash must be applied using lusterless paint and/or decals.

6.4.4. Aircraft Names. Aircraft Names are authorized on PACAF aircraft only after approval by USAF/CV. The proposed name must either have a national or military theme or honor a locale adjacent to a PACAF base or aircraft manufacturing point. Route recommendations through your WG/CC to PACAF/PA; include the proposed name and detailed justification. If applied in addition to nose art, the aircraft name and nose art must be complementary; the font, size, and location may be changed to complement the nose art.

6.4.5. Air Force Outstanding Unit Award. The Air Force Outstanding Unit Award (AFOUA) may be applied if applicable. AFOUA decals, with and without oak leaf clusters, are available from <https://dso.dla.mil/>.

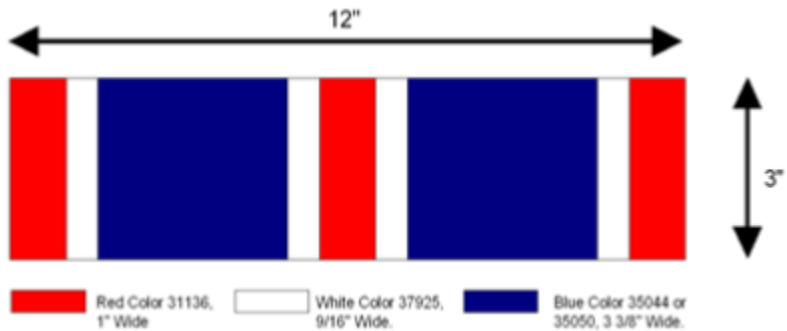
Figure 6.1. Outstanding Unit Award.

6.4.6. Air Force Meritorious Unit Award (MUA) may be applied immediately adjacent to the AFOUA if applicable.

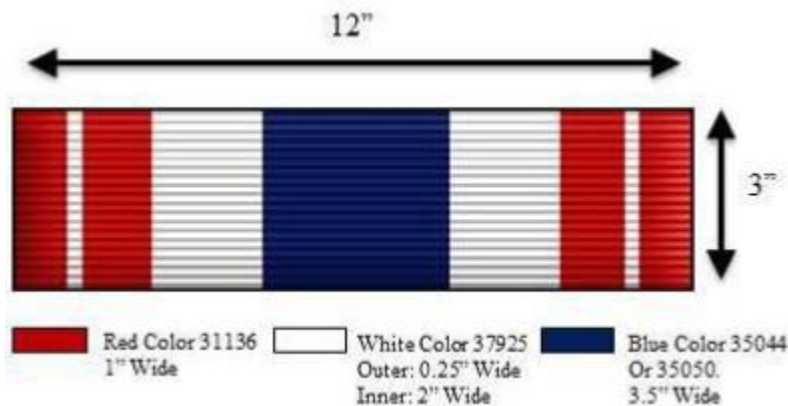
Figure 6.2. Meritorious Unit Award.

6.4.7. Boom Elevator Markings. Boom elevator markings may be applied in accordance with the appropriate table, weapon system specific T.O., and/or weapon system drawings with the approval of the Wing Commander.

6.4.8. Wing Pride Aircraft. Each Wing Commander may designate one aircraft to be the wing pride aircraft; this aircraft is authorized the additional markings stated below.

6.4.8.1. Wing CC/CV names and Group Commander's names (list all group commanders or none) may be used in place of the DCC names. The wing designator may be included in the name block. Prior to deployment or flight into a combat zone (including transient aircraft), all names will be removed from the aircraft. **(T-2)**

6.4.8.2. Tail Flash may contain colors/numbers of all squadrons assigned to the wing but must remain within the tail band stripes specified in the applicable table. Refer to [paragraph 6.3](#). **(T-2)**

6.4.8.3. Wing mascot/logo may be applied as nose art (in addition to the one per flying squadron), [paragraph 6.5.5](#) applies.

6.4.9. Dedicated Crew Chief (DCC)/Assistant Dedicated Crew Chief (ADCC). If elected, DCC and ADCC names will be applied in accordance with T.O. 1-1-8 and placed on interior placards or exterior of the aircraft. See [Attachment 2](#). Units will be consistent when selecting interior or exterior placards. **(T-2)** Aircraft will adhere to sanitization methods for all aircraft in accordance with T.O. 1-1-8. **(T-2)**

6.4.9.1. Prior to deployment into a combat zone, regardless of tour length, all marking will be sanitized in accordance with T.O. 1-1-8. Consistency across the wing is paramount. MAJCOM/A4, WG/CCs, and MXG/CCs are authorized to direct the removal of all names for the duration of contingency operations. **(T-2)**

6.4.9.1.1. Transient aircraft. PACAF defines transient as an aircraft that temporarily stops at a destination and has a final destination elsewhere. **(T-2)**

6.4.9.1.2. Aircrew and DCC/ADCC exterior name markings are authorized to remain on aircraft when transiting a combat zone for 30 days or less. **(T-2)**

6.4.9.2. The name will consist of the abbreviated rank, first name, and last name. The first name can be either the given proper name (William, Robert, Daniel, etc.) or the more familiar shorter form (Bill, Bob, Dan, etc.). The use of an individual's middle name or initial is optional. For extremely long names, it is permissible to use the individual's rank, first initial and last name or to use smaller letters to accommodate the entire name.

6.4.9.3. Nicknames are not authorized. Size and font are at the MXG/CC's discretion; size not to exceed 2 ½ inches; standardized within the wing. Unit mascot graphics, i.e., razorback and eagle head (outlines or silhouettes) may be used as the forward edge of the placard or crew chief block. For standardization purposes, either all or none of the wing aircraft will bear the graphic.

6.4.10. AMU/FGS/Squadron/Wing Colors. Each operational squadron may have its colors and/or logos applied within the boundaries of the tail stripes, or the entire wing may share one tail stripe design.

6.5. Aircraft Mandatory Markings (Combat Aircraft).

6.5.1. **Command Insignia.** The application of the command insignia on aircraft is mandatory. Fighter type aircraft will use subdued insignias. Size and location of command insignias by MDS are specified in [Attachment 2](#).

6.5.2. **Organizational Insignia.** The application of wing insignia is mandatory. The insignia will be applied to both sides of the forward fuselage. The operational squadron insignia may be applied on the left side in place of the wing insignia. Wing and squadron insignias will be subdued for fighter aircraft.

6.5.3. **Distinctive Unit Identifier Marking.** The application of the unit identifier is mandatory for all Combat Air Force (CAF) aircraft unless otherwise directed. ACC/A4M is the office of primary responsibility (OPR) for the assignment of AF unit designators as directed by T.O. 1-1-8. The primary factor used to determine unit identifier is the aircraft/unit assignment location.

6.5.3.1. The unit identifier will be applied in accordance with guidelines T.O. 1-1-8 or the applicable weapon system T.O. and guidelines contained in [Attachment 2](#) of this instruction.

6.5.4. **Paint Identification Placard.** The paint identification block is a mandatory marking and is intended to provide important paint information, i.e., type of paint and associated hazards.

6.5.5. **Nose Numbers.** Aircraft nose numbers will be in block or Helvetica letters, not to exceed four digits. Specific location and size for each different type aircraft is contained in [Attachment 2](#). The paint material(s) used to apply nose numbers will have the same gloss or subdued requirement as the base aircraft coating.

6.6. Aircraft Optional Markings (Combat Aircraft).

6.6.1. **Tail Stripe.** Tail stripes are used to identify aircraft operation squadrons and are authorized as a wing option on all aircraft except F-35 aircraft.

6.6.2. Each flying squadron will have a standardized tail stripe unique to that squadron, and the use of the same tail stripe by two or more squadrons within a wing is not permitted. **(T-2)** Commanders' aircraft, as defined in [paragraph 6.6.4](#), may have a unique tail stripe, but must remain within the guidelines of this instruction.

6.6.2.1. Tail stripe will be applied to the upper portion of the vertical stabilizer in the form of a straight stripe. Width will not exceed 9 inches on fighter aircraft.

6.6.2.2. Tail stripe may be any color or pattern, and may contain a logo with the following exceptions:

6.6.2.2.1. Tail stripe on F-22 aircraft will be subdued and must meet all Technical Order Data (TOD) requirements.

6.6.2.2.2. Tail stripe on aircraft bearing the American Flag will be solid in color and will not contain any logo, name, or lettering.

6.6.2.2.3. On aircraft with multiple vertical stabilizers, the tail stripe may be of either a wrap-around style on both vertical stabilizers or applied to the outboard sides of each vertical stabilizer.

6.6.2.2.4. Units will not repaint tail flashes/stripes or F-35 special unit markings during deployed operations unless otherwise directed by the combatant commander. **(T-2)**

6.6.3. **Aircrew and Crew Chief Names.** Aircrew and dedicated crew chief/assistant names may be applied to all command aircraft as a unit option but must be removed prior to deployment from home station in direct combat zones or when participating in contingencies that may subject aircraft to hostile fire abroad.

6.6.3.1. Units are encouraged to keep name changes to the minimum as the removal/application of decals can cause damage to the coating system and is especially of concern on LO platforms/surfaces as it can negatively affect the radar cross section.

6.6.3.2. Application of nicknames, punctuation, and/or call signs is not authorized.

6.6.3.3. All aircraft in the wing will be standard in color, style, and size of letters, but will not exceed 3 inches in height. The only exception is that designated commander aircraft may have different color, style and/or size lettering, but will not exceed 3 inches in height.

6.6.3.4. A background block for pilot/crew chief names may be used, should give a subdued appearance, and be in contrasting color to the section of the aircraft where applied. It may be other than rectangular in shape and to further an MDS theme, the block may be preceded by a design depicting the MDS e.g., F-15 eagle head, F-16 falcon head, etc.

6.6.4. Commander's Aircraft Markings. Commander's aircraft referred to in this instruction are those designated as Numbered Air Force (NAF), Wing, OG, and commanders of flying squadrons (Fighter/Reconnaissance). The NAF Commander may select one wing within the command to have one aircraft specifically marked; it will be the only aircraft authorized so marked. Wing, OG and flying squadron commanders are authorized to designate one aircraft each to be marked. For Total Force Integration (TFI) locations under classic association, the Wing Commander may authorize one aircraft to be identified as the associate ANG or AFRC Commander's aircraft. COMPACAF may select one aircraft within the command to be specifically marked; it will be the only aircraft authorized so marked. The following guidance governs markings authorized for a commander's aircraft:

6.6.4.1. Wing and/or NAF insignias on the right forward fuselage and a collage of assigned flight/operations squadron insignias on the left forward fuselage.

6.6.4.2. Unit identifier and radio call numbers. Unit Identifier and radio call numbers will remain on vertical stabilizers as depicted in T.O. 1-1-8, applicable weapons system T.O., and this instruction. Highlighting (shadowing) of unit identifier and radio call number on the vertical tail(s) is authorized on all designated commander aircraft except F-35 units. All highlighting will be done in contrasting gray, black or white and must meet the primary basecoat gloss requirement e.g., flat, semi-gloss, gloss.

6.6.4.3. **Anniversary markings.** This policy is provided to allow latitude for application of anniversary logo markings to Wing Commander aircraft only.

6.6.4.3.1. Wing commanders will review all requests for fiscal responsibility. **(T-2)** Proposed markings must be further be coordinated through local Public Affairs, local Staff Judge Advocate, Base Historian, and approved by the Wing Commander prior to application.

6.6.4.3.2. Size of marking will be no larger than nine square feet. Location on the aircraft is at wing commander discretion but will not interfere with required aircraft markings.

6.6.4.3.3. Anniversary markings will meet primary basecoat gloss requirements and will not alter nor interfere with T.O. 1-1-8 and weapon system specific T.O. guidance and/or markings. State flags and logos other than anniversary type are not authorized.

6.6.4.4. Applied anniversary marking(s) must be removed within 60 days following the anniversary period (1-year maximum time period). Extension requests must be submitted by the Wing Commander to PACAF/A4M for consideration. **(T-2)**

6.6.4.5. **Bird Of Prey Silhouette.** Bird of prey silhouettes are authorized on F-15 and F-16 aircraft as a unit option but must be standardized within a wing by MDS. The following guidelines apply:

6.6.4.5.1. F-15 Aircraft. The silhouette will be placed on the insides of the vertical stabilizers. They will not exceed 24 inches in height and must be applied in a contrasting gray color.

6.6.4.5.2. F-16 Aircraft. The silhouette can be placed anywhere on the aircraft if it does not interfere with standard required markings. The silhouette will not exceed 18 inches in height and must be applied in a contrasting gray color.

6.6.4.6. **Aerial Victory Marking.** Fighter aircraft awarded a verified aerial victory are authorized to display a 6-inch green star with a 1/2-inch black border located just below and centered on the pilot's name block. The type of aircraft shot down must be stenciled inside the star in 1/2-inch white lettering. For aircraft with multiple aerial victories, a star is authorized for each aircraft shot down. No other victory markings are authorized.

6.6.4.7. **A-10, F-15, F-16 Combat Marking.** Deployed units supporting combat operations are authorized to place combat markings (bomb and 20/30MM ammunition) on aircraft operating at deployed locations using the following criteria. The combat markings will be placed inside the pilot/DCC name placard (name markings must be sanitized/removed during deployment) on A-10, F-15 and F-16 aircraft. The markings will be displayed using contrasting shades conforming to the basic aircraft camouflage requirements. Cut the stencils out of a removable adhesive marking material. The bomb markings are intended to generically represent each general-purpose conventional bomb (e.g., GBU-12/31/38s and MK-82s) dropped at a one-to-one ratio and each 20/30-mm ammo round silhouette represents 100 rounds, or one pass. The Air Expeditionary Wing is responsible for providing the stencil machine/materials and removing the combat markings prior to redeployment.

6.7. Aircraft Travel Pods. Travel pods will be painted the same color and tone as the aircraft with no additional markings. Gloss paint may be used to aid in cleaning. Units with multicolor aircraft should select one primary color of the aircraft for the travel pod. Lettering will be subdued in color but will not exceed 6 inches in height.

6.8. External Fuel Tanks. External fuel tanks will be painted the same color and tone as existing aircraft coating. A 2-inch marking (centered on lugs) is optional for tracking purposes.

6.9. Competition Aircraft.

6.9.1. Units participating in competitions will follow the guidelines established in competition rules for aircraft appearance. **(T-2)** Competitions should be considered "come as you are" and no waivers will be granted. "Come as you are" is defined as no special effort, painting, or additional markings applied to enhance or improve the overall appearance of the aircraft. This includes polishing of metal surfaces, using commander type markings, etc.

6.10. Aircraft Transfer.

6.10.1. The following markings must be removed prior to formal transfer of aircraft to other units or MAJCOMs (aircraft retiring to Aerospace Maintenance and Regeneration Group need not have any markings removed). Deviations from transfer requirements are authorized provided the gaining and losing units reach a mutual agreement **(T-2)**

6.10.1.1. Organizational insignias.

6.10.1.2. Unit identifier.

- 6.10.1.3. Tail stripe.
- 6.10.1.4. Aircrew and crew chief names.
- 6.10.1.5. Unit unique markings.
- 6.10.1.6. Nose art.

6.11. Waivers.

6.11.1. Wing Commanders must submit waiver requests to pacaf.a4mv3@us.af.mil. (T-2) Waivers that are in violation of aircraft technical data will not be accepted. Waiver requests must include the following:

- 6.11.1.1. Clear statement of present procedure/markings.
- 6.11.1.2. Clear statement of proposed change.
- 6.11.1.3. Justification to include historical significance, if applicable.
- 6.11.1.4. Digital color photographs, one of present marking and one of requested change. The use of a slide presentation format is allowed.

6.11.2. All approved waiver documentation must be kept on file by owning organization.

6.12. Historical Requirements. Aircraft Structural Maintenance and/or Low Observable section will maintain a record of all current unit unique markings, e.g., commanders' aircraft, tail stripes, travel pods, paint ID placard, etc. (T-2)

6.12.1. In addition, units will file a copy of all wing approval memorandums and photos with the applicable base historian and will send a copy to the MAJCOM Corrosion Program Manager (pacaf.a4mv3@us.af.mil). (T-2)

6.13. Tone Down.

6.13.1. **Test equipment/composite tool kits (CTKs).** Tone down of test equipment, CTKs and like equipment will be determined by the aircraft gloss requirement, i.e., unit with aircraft having gloss finishes may apply gloss finishes to their test equipment and CTKs. If the aircraft assigned have a requirement for flat finishes, then all test equipment and CTKs designed for on-equipment application will be toned down in flat colors.

- 6.13.1.1. To prevent obscuring of instructions and possible damage to components, only exteriors of test equipment boxes will be toned down.
- 6.13.1.2. Test equipment and CTKs used outside the shop environment will be toned down, i.e., gray, olive drab, brown, black or forest green. A camouflage pattern incorporating a combination of these colors may be used.
- 6.13.1.3. Equipment not removed from back shops need not be toned down i.e., test equipment, test benches, and mockups.

6.13.2. **Tactical Air Control System (TACS) Equipment Requirements.** TACS shelters, vehicles, and support equipment will be camouflage pattern painted using chemical agent resistant coating in accordance with T.O. 36-1-171, *Painting Instruction for Army Material*.

6.13.2.1. TACS shelters, vehicles and support equipment will be pattern painted in a three-color camouflage scheme in accordance with T.O. 36-1-161, *Color, Marking, and Camouflage Painting of Military Vehicles, Construction Equipment and Materials Handling Equipment* and authorized equipment specific technical guidance.

6.13.2.2. Reflective tape, signs, and decals will not be applied.

6.13.2.3. Fabric or inflatable shelters will not be painted in accordance with this instruction.

6.13.2.4. Mobilizers can be toned down in the solid complementary colors of desert sand or forest green.

6.13.3. **Alternate Mission Equipment (AME)**. AME will be painted in accordance with specific technical data. When such data does not exist, units will coordinate with the applicable item manager and PACAF/A4M before changing paint schemes.

PATRICK G. MILLER, Colonel, USAF
Director of Logistics, Engineering and Force
Protection

(8FW)

KATHRYN K. GAETKE, Colonel, USAF
Commander

Attachment 1

GLOSSARY OF REFERENCES AND SUPPORTING INFORMATION

References

In addition to required/recommended publications, each Section will maintain publications for possessed equipment in accordance with T.O. 00-5-1, *AF Technical Order System*.

(Added-8FW) AFD 21-1, *Maintenance of Military Materiel*, 21 Feb 2024

DAFI 21-101, *Aerospace Equipment Maintenance Management*, 15 January 2020

DAFI 24-602 Volume 2, *Cargo Movement*, 12 June 2019

AFI 33-322, *Records Management and Information Governance Program*, 27 July 2021

AFI 48-145, *Occupational and Environmental Health Program*, 11 July 2018

AFI 63-101/20-101, *Integrated Life Cycle Management*, 29 June 2020

DAFI 63-140, *Aircraft Structural Integrity Program and Air and Space Equipment Structural Management*, 6 August 2020

DAFMAN 32-1084, *Standard Facility Requirements*, 14 January 2020

DAFMAN 91-203, *Air Force Occupational Safety, Fire, and Health Standards*, 25 March 2022

(Added-8FW) T.O. 1F-16CM-5-2, *Loading Data*, 1 Jun 2022.

UFC 4-211-02, *Aircraft Corrosion Control and Paint Facilities*, 12 February 2013

T.O. 00-20-3, *Maintenance Processing of Reparable Property and the Repair Cycle Asset Control System*, 17 December 2021

T.O. 00-20-14, *Air Force Metrology and Calibration Program*, 28 February 2022

T.O. 00-25-107, *Maintenance Assistance*, 01 October 2015

T.O. 00-25-172, *Ground Servicing of Aircraft and Static Grounding/Bonding*, 23 May 2022

T.O. 00-25-195, *AF Technical Order System Source Maintenance, and Recoverability Coding of Air Force Weapons, Systems, and Equipment*

T.O. 00-25-252, *Intermediate and Depot Level Maintenance Instructions Aeronautical Equipment Welding*, 22 July 2022

T.O. 00-35D-54, *USAF Deficiency Reporting, Investigation, and Resolution*, 15 April 2021

T.O. 1-1-8, *Application and Removal of Organic Coatings, Aerospace and Non-Aerospace Equipment*, 08 June 2022

T.O. 1-1-689-3, *Cleaning and Corrosion Control Volume III Avionics and Electronics*, 15 January 2016

T.O. 1-1-690, *General Advanced Composite Repair Processes Manual*, 08 November 2016

T.O. 1-1-691, *Cleaning and Corrosion Prevention and Control, Aerospace and Non-Aerospace Equipment*, 21 August 2021

- T.O. 33-1-27, *Maintenance Support of Precision Measurement Equipment*, 17 August 2013
- T.O. 33-1-37-1, *Joint Oil Analysis Program Manual Volume I*, 15 September 2014
- T.O. 33-1-37-2, *Joint Oil Analysis Program Manual Volume II*, 01 June 2015
- T.O. 33-1-37-3, *Joint Oil Analysis Program Manual Volume III*, 30 June 2019
- T.O. 34A-1-1, *Additive Manufacturing Qualification of Technicians, Machines and Facilities*, 17 June 2022
- T.O. 34A-2-1, *Metals Additive Manufacturing General Procedures and Process Controls*, 1 July 2022
- T.O. 34A-3-1, *Polymers Additive Manufacturing, General Procedures and Process Controls*, 21 June 2022
- T.O. 35-1-3, *Corrosion Prevention and Control, Cleaning, Painting, and Marking of USAF Support Equipment*, 26 January 2022
- T.O. 36-1-161, *Color, Marking, and Camouflage Painting of Military Vehicles, Construction Equipment and Materials Handling Equipment*, 7 May 1991
- T.O. 36-1-171, *Painting Instructions for Army Material*, 30 June 2008

Prescribed Forms

None

Adopted Forms

- (Added-8FW) DAF Form 679, *Department of the Air Force Publication Compliance Item Waiver Request/Approval*
- DD Form 2757, *Welding Examination Record*
- AFTO Form 781A, *Maintenance Discrepancy and Work Document*
- AFTO Form 95, *Significant Historical Data*
- DAF Form 847, *Recommendation for Change of Publication*
- (Added-8FW) LCL-8MXG-023, *Post-Wash Corrosion Inspection Procedures*

Abbreviations and Acronyms:

- ACC**—Air Combat Command
- AFCENT**—Air Force Central Command
- AFI**—Air Force Instruction
- AFMAN**—Air Force Manual
- AFOSH**—Air Force Occupational Safety and Health
- AFPD**—Air Force Policy Directive
- AFRC**—Air Force Reserve Command

AFRIMS—Air Force Records Information Management System
AFRL—Air Force Research Laboratory
AFSC—Air Force Specialty Code
AGE—Aerospace Ground Equipment
ALC—Air Logistics Center
ALIS—Autonomic Logistics Information System
AME—Alternate Mission Equipment
(Added-8FW) AMMO—Aircraft Munitions Maintenance organization
AMU—Aircraft Maintenance Unit
AMX—Aircraft Maintenance
AMXS—Aircraft Maintenance Squadron
ANG—Air National Guard
APC—Advance Performance Coatings
ARC—Air Reserve Component
(Added-8FW) ASIP—Aircraft Structural Integrity Program
ASM—Aircraft Structural Maintenance
BCE—Base Civil Engineer
CAF—Combat Air Force
CC—Commander
CE—Civil Engineering
CEM—Communications-Electronics-Meteorological
(Added-8FW) CIRE—Common Inspection Reporting Engine
CMS—Component Maintenance Squadron
CPAB—Corrosion Prevention Advisory Board
CPCP—Corrosion Prevention and Control Program
CTK—Composite Tool Kit
DAFI—Department of the Air Force Instruction
DAFMAN—Department of the Air Force Manual
DoD—Department of Defense
DR—Deficiency Reports
EMS—Equipment Maintenance Squadron
ESA—Electrical Surge Arrestor

FAC—Forward Air Control
FGS—Fighter Generation Squadron
FTD—Field Training Detachment
HAZMART—Hazardous Material
HQ—Headquarters
HVAC—Heating, Ventilation and Air Conditioning
ICBM—Intercontinental Ballistic Missile
IC—Interim Change
IMDS—Integrated Maintenance Data System
IMIS—Integrated Maintenance Information System
IPT—Integrated Process Teams
JOAP—Joint Oil Analysis Program
(Added-8FW) JST—Job Standard
LOCRF—Low Observable/Composite Repair Facility
LO—Low Observable
LRU—Line Replaceable Units
MAJCOM—Major Command
MDS—Mission Design Series
MOA—Memorandum of Agreement
MSDS—Material Safety Data Sheet
NAF—Numbered Air Force
NCO—Noncommissioned Officer
NDI—Non-Destructive Inspection
NESHAP—National Emission Standards for Hazardous Air Pollutants
OAP—Oil Analysis Program
OPR—Office of Primary Responsibility
PGM—Product Group Manager
PIT—Product Improvement Team
PR—Personnel Recovery
QA—Quality Assurance
QPD—Qualified Product Database
QPL—Qualified Products Listings

QPT—Quality Training Package
QTP—Quality Training Package
RAM—Radar Absorbing Material
RCS—Radar Cross Section
RDS—Records Disposition Schedule
RDT&E—Research, Development, Test and Evaluation
RPIE—Real Property Installed Equipment
RTO—Responsible Test Organization
SAS—Signature Assessment System
SEM/EDX—Scanning Electron Microscope/Energy Dispersive X-Ray
SE—Support Equipment
SMD—Structural Management Director
SME—Subject Matter Expert
SMP—Signature Management Program
SPD—System Program Directorate
SPM—System Program Manager
STD—Standard
T.O.—Technical Order
TACS—Tactical Air Control System
TDY—Temporary Duty
TFI—Total Force Integration
TMDE—Test, Measurement and Diagnostic Equipment
TOD—Technical Order Data
UFC—Unified Facilities Criteria
USAF—United States Air Force
(Added-8FW) WCE—Work Center Event

Attachment 2

AIRCRAFT MARKING SPECIFICATIONS

A2.1. (Not all inclusive, refer to specific weapon system T.O. or drawings for further guidance) .

Table A2.1. A-10 Markings.

Marking	Location	Size	Color/Finish
Tail Stripe	Per local instruction	Not to exceed 9 inches	Per local instruction
PACAF Command Patch	Outboard side of both vertical stabs; Vertical: 10 inches below bottom edge of rudder cap Horizontal: Centered on unit identifier	10 inches tall	36118
Unit Unique Silhouette (per local instruction)	On both vertical stabs; Vertical: Centered between PACAF command patch and unit identifier Horizontal: Centered on vertical stab, excluding rudder measurement	Per local instruction	36118
Unit Identifier "OS"	Outboard side of both vertical stabs; Vertical: Bottom of letters located 3 inches above top of tail numbers Horizontal: Centered on tail numbers	10 inches tall	36118
Aircraft Tail Numbers	Marked in accordance with T.O. 1A-10() - 23	6 inches tall	36118
Wing Patch	On left side of fuselage; Vertical; Above panel F-18 Horizontal: Aft of panel F-44	10 inches tall	36118
Squadron Patch	On right side of fuselage; Vertical; Above panel F-79 Horizontal: Aft of panel F-105	10 inches tall	36118
Pilot and Crew Chief Names	Pilot name located on left side under windscreen beginning at FS 188.92. Crew chief name located under pilot name. Assistant crew chief name located under crew chief name.	Not to exceed 2 inches tall	Per local Instruction
Nose Numbers	Last three/four digits of tail number on both sides of aircraft nose	6 inches tall	36118

A2.2. C-17 Markings.

A2.2.1. All C-17 markings will be in accordance with T.O. 1C-17A-23. Crew names are optional.

A2.3. C-130 Markings.

Table A2.2. C-130 Markings.

Marking	Location	Size	Color/Finish
Tail Stripe	Horizontal wrap around stripe. Top of stripe located at vertical stabilizer station 265.	12 inches tall	Per local instruction
American Flag	On both sides of vertical stab; Vertical: Top of flag located 23 inches below the vertical stab antenna (178 inches from base of vertical); Horizontal: centered on vertical stab (excluding rudder measurements).	24 X 48 inches	Matte Finish
PACAF Command Patch	On both sides of vertical stab; Vertical: Top of patch located 6 inches below bottom of flag Horizontal: centered on vertical stab (excluding rudder measurements).	24 inches tall	Subdued
Unit Unique Silhouette (per local instruction)	On both sides of vertical stab; Vertical: Centered between PACAF command patch and unit identifier Horizontal: Centered on vertical stab, excluding rudder measurement	Not to exceed 24 inches tall x 36 inches long	Per local instruction
Unit Identifier “YJ”	On both sides of vertical stab; Vertical: Bottom of unit identifier located at vertical stab station 63. Horizontal: Centered between FS 1068 and 1122.	36 inches tall	37038
Radio Call Numbers	On both sides of vertical stab; Vertical: Bottom of radio call numbers located at vertical stab station 36. Horizontal: Centered between FS 1068 and 1122.	15 inches tall	37038

Marking	Location	Size	Color/Finish
Wing Patch	Left fuselage; Vertical: 8 inches above first porthole beneath light panel Horizontal: Centered between FS 245.0E and FS 245.00	12 inches tall	Black
Squadron Patch	Right fuselage symmetrically located same as wing patch.	12 inches tall	Black
Aircraft Commander and Crew Chief Names	Vertical: Bottom of name block on WL175.0 Horizontal: Center between FS 175.0 and FS 210.0.	Per local instruction	Subdued
Crew Names (Optional)	Left side of fuselage only. Centered between aft edge of crew entrance door and fuselage light hinge. Bottom of block located 6 inches above top of beef up plate	Per local instruction	Matte Black
Nose Numbers (Number will consist of last four digits of aircraft serial number)	On both sides of fuselage; Vertical: Aligned with the bottom of the kick window Horizontal: 23 inches aft of kick window	6-inch block letters	Black
Wing Designation	On both sides of fuselage; Vertical: 6 inches below nose numbers Horizontal: The last letter of the Wing designator will be aligned with last digit of the nose numbers.	6-inch block letters	Black
Armament Placard	Top of placard located 15 inches below top of CED door and 5 inches aft of the door. The word “ARMAMENT” will be located $\frac{3}{4}$ ” below upper border of placard.	16 X 10 inches with 1 inch border	37038

Figure A2.1. C-130 Markings.

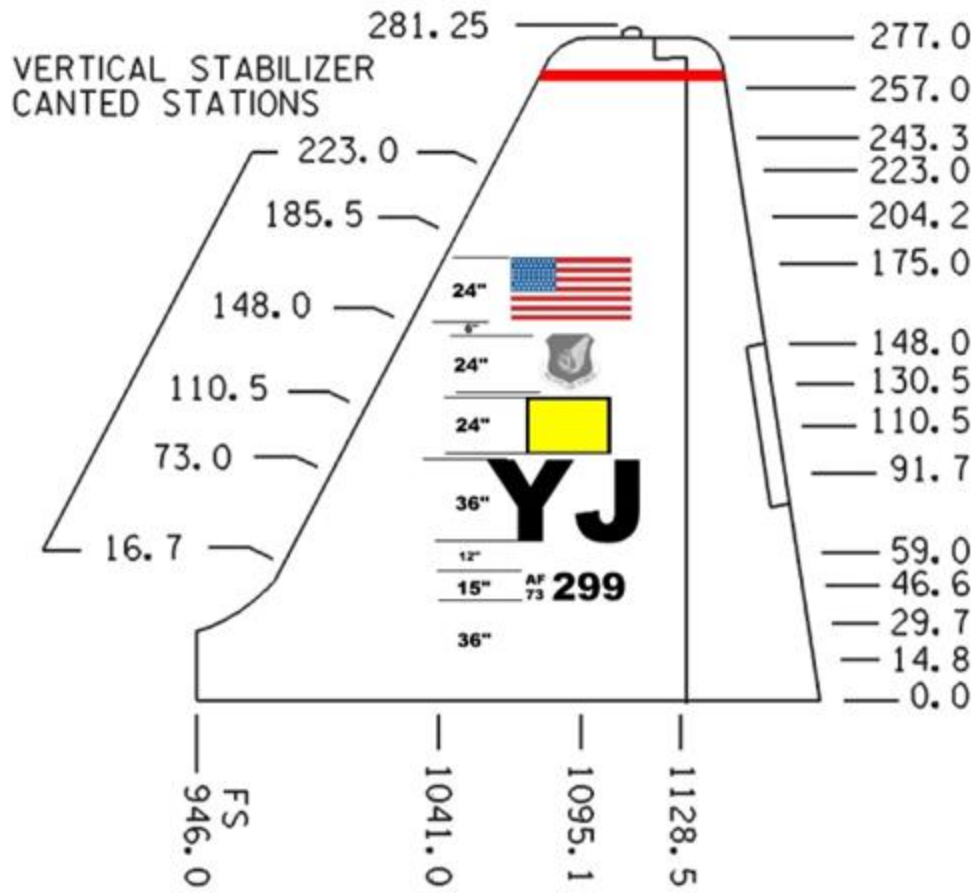

A2.4. E-3 Markings.

Table A2.3. E-3 Markings.

Marking	Location	Size	Color/Finish
Tail Stripe	Horizontal stripe on both sides of tail. Top of stripe located at WL 557.1	Not to exceed 24 inches tall	Per local instruction
American Flag	Applied to both sides of the vertical stabilizer. The top of the American flag is located at Fin Station 210.15 with the forward top corner of each flag resting on the vertical stabilizer leading edge seam.	60 x 31.5 inches	Per T.O. Guidance
PACAF Command Patch	Centered 12 inches fwd Sta 259.5. Top of insignia 40 inches above Stringer 19 on co-pilot's side	18 inches tall	Black silhouette
Unit Unique Silhouette (per local instruction)	On both sides of vertical stab; Vertical: Centered between American flag and unit identifier Horizontal: Centered on vertical stab, excluding rudder measurement	Not to exceed 24 inches tall x 36 inches wide	Per local instruction
Unit Identifier	Left side: Located 7 inches above the radio call number with the top corner of the first letter at the leading-edge seam Right side: Located 7 inches above the radio call number with the top corner of the last letter at the leading-edge seam	24 inches tall	Gloss Black
Aircraft Tail Numbers	On both sides of vertical stab; 7 inches below unit identifier	12 inches tall	Gloss Black
Wing Patch	Centered 12 inches fwd Sta 259.5. Top of insignia 40 inches above Stringer 19 on pilot's side	18 inches tall	Black silhouette
Pilot and Crew Chief Names	In a 1/4" black bordered, 30 1/2" by 11 1/2" box, just below the commander's window on the left side of the aircraft with the upper edge of the box 40" plus or minus 0.50" above the edge of the skin stringer 19, running from body station 227.8 to 203.8 will be the words "ACFT	Per verbiage	Per verbiage

Marking	Location	Size	Color/Finish
	<p>Commander" in Helvetica medium with 1.13" lettering with the individuals name centered below it in Brush Script with 1.695" lettering. Below the ACFT Commander's name will be the words "Dedicated Crew Chief" in Helvetica medium in 1.13" lettering with the individuals name centered below it in Brush Script in 1.695" lettering. The stencil will be placed 1/4" below seam and 1/2" forward of window beef up plate (all lettering will be black).</p> <p>In a 1/4" black bordered, 30 1/2" by 11 1/2" box just below the Pilots window on the right side of the aircraft, with the upper edge of the box 40" plus or minus .50" above the skin stringer 19, running from body station 227.8 to 203.8 will be the words "MCC" in Helvetica medium with 1.13" lettering with the individuals name centered below it in Brush Script with 1.695" lettering. Below the MCCs' name will be the word "ADCC" in Helvetica medium with 1.13" lettering with the individuals name centered below it in Brush Script with 1.695" lettering. The stencil will be placed 1/4" below seam and 1/2" forward of window beef up plate (All lettering will be black).</p>		
Nose Numbers	Last four digits of tail number on left and right nose gear door	6 inches tall	Gloss Black

A2.5. F-15 Markings.

Table A2.4. F-15 Markings.

Marking	Location	Size	Color/Finish
Tail Stripe	Per local instruction	6 inches tall	Per local instruction
PACAF Command Patch	Vertical: Bottom of insignia 18 inches above unit designator Horizontal: Aft edge of insignia of FS 806.5	18 inches tall	37038
Unit Unique Silhouette (per local instruction)	Inside surface of both vertical stabs; Vertical: Centered between PACAF command patch and unit identifier Horizontal: Centered on vertical stab, excluding rudder measurement	Per local instruction	Per local instruction
Unit Identifier "ZZ"	On both vertical stabs; Vertical: Top of letters even with top of rudder Horizontal: Leading edge of first letter on FS 760.0	24 inches tall	37038
Aircraft Tail Numbers	Follow specific -23 T.O. reference for location.	15 inches tall	37038
Wing Patch	On left side of fuselage; Vertical: Bottom of insignia on WL 100.0 Horizontal: Forward edge of insignia on FS 458.0	18 inches tall	37038
Squadron Patch	On right side of fuselage; Vertical: Bottom of insignia on WL 100.0 Horizontal: Forward edge of insignia on FS 458.0	18 inches tall	37038
Pilot and Crew Chief Names	Pilot centered below left windscreen frame and crew chief and assistant crew chief names centered below right windscreen frame.	Not to exceed 2 inches tall	Per local Instruction
Nose Numbers	Last three/four digits of tail number vertically on left and right side of the nose gear door or on the aircraft nose 1 inch below the EWWS antenna with the last number ending 1 inch from radome.	4 inches tall	37038

A2.6. F-16 Markings.

Table A2.5. F-16 Markings.

Marking	Location	Size	Color/Finish
Tail Stripe	Horizontal wrap around stripe. Top of stripe located at WL 217.5	6 inches tall	Per local instruction
PACAF Command Patch	On both sides of vertical stab; Vertical: Top of patch 5 inches below bottom of tail stripe Horizontal: Centered on vertical stab, excluding rudder measurement	10 inches tall	36118
Unit Unique Silhouette (per local instruction)	On both sides of vertical stab; Vertical: Centered between PACAF command patch and unit identifier Horizontal: Centered on vertical stab, excluding rudder measurement	Not to exceed 16 inches tall x 30 inches long	36118
Unit Identifier “OS”, “WP”, “WW”, “AK”	On both sides of vertical stab; Vertical: Bottom of letters at WL 157.5 Horizontal: Centered on vertical stab, excluding rudder measurement	18 inches tall	36118
Aircraft Tail Numbers	Marked in accordance with T.O. 1F-16()-2-00GV-00-1	12 inches tall	36118
Wing Patch	On left side of fuselage; Vertical; Top of patch 11 inches below fuselage/intake splitter vane Horizontal: Leading edge 52 inches aft of intake duct lip	10 inches tall	36118
Squadron Patch	On right side of fuselage; Vertical; Top of patch 11 inches below fuselage/intake splitter vane Horizontal: Leading edge 52 inches aft of intake duct lip	10 inches tall	36118
Pilot and Crew Chief Names	Pilot name located on left canopy rail. Crew chief name located on right canopy rail. Assistant crew chief name located on inside of nose gear door.	Not to exceed 2 inches tall	Per local Instruction
Nose Numbers	Last three/four digits of tail number on both sides of nose gear door or centered	4 inches tall	36118

Marking	Location	Size	Color/Finish
	below teardrop EWWS antenna on each side of aircraft nose		

Figure A2.2. Typical Paint Scheme.

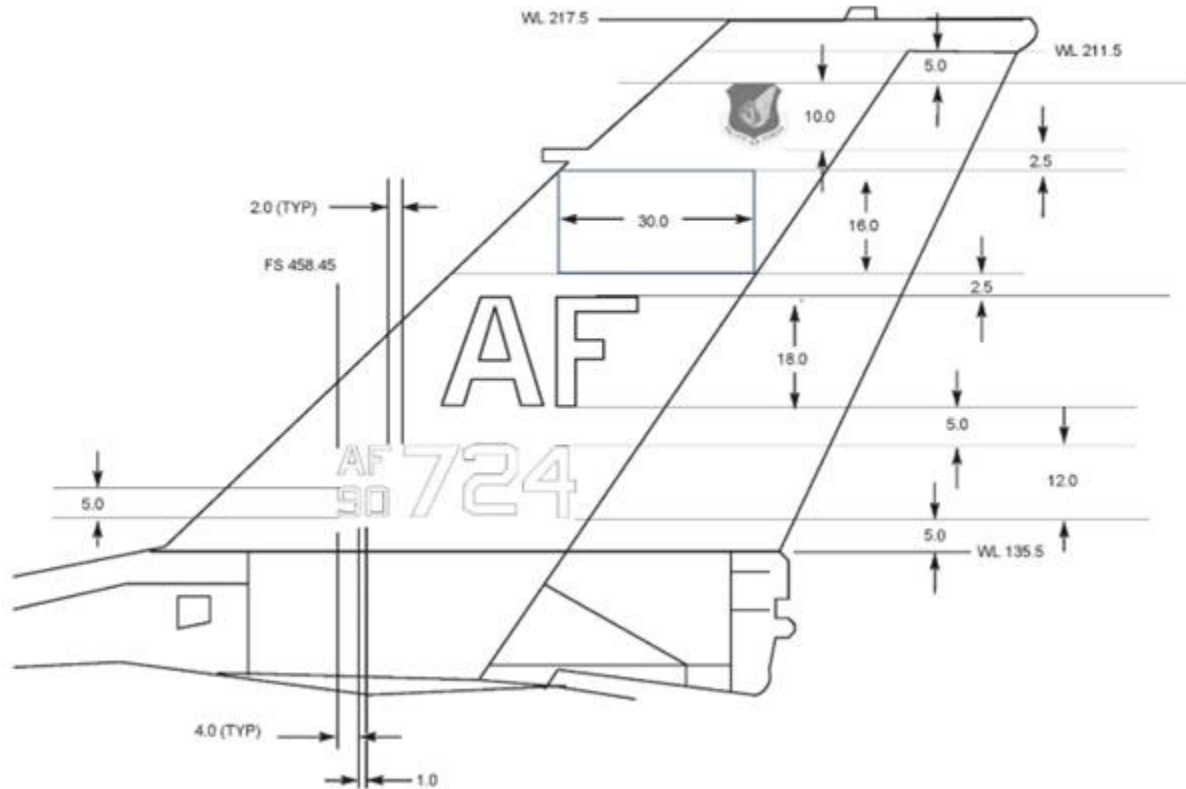

A2.7. Unique Paint Scheme.

A2.7. (8FW) Unique Paint Scheme.

A2.7.1. **Aggressor Aircraft (Eielson Only)** Aircraft are authorized to be painted using the “Artic”, “Blizzard”, “Desert”, “Fulcrum”, “Lizard”, “Shark”, “Splinter”, or “Wraith” paint scheme, however, units must submit for engineer approval in accordance with T.O. 00-25-107, *Maintenance Assistance*, prior to paint application. Unless approved by T.O. guidance all other paint scheme change requests require approval prior to painting in accordance with T.O. 1-1-691, *Application and Removal of Organic Coatings, Aerospace and Non-Aerospace Equipment*, in conjunction with T.O. 00-25-107, *Maintenance Assistance*.

A2.7.2. F-16 units operating in icing conditions are authorized to paint a flat black (color code 37038) ring around the inside lip of the engine inlet duct to aid in the detection of ice build-up. In these cases, units will pay particular attention not to paint over any rain erosion coating as this may lead to premature failure of the rain erosion coating. **(T-2)** Flat black ring should be painted on first white section of inlet lip RAM coating.

A2.7.3. **(Added-8FW)** F-16 units with the monotone coating (color code 36170) are authorized to use flat black (color code 37038) for aircraft markings.

A2.7.4. **(Added-8FW)** Command aircraft are authorized to be painted IAW DAF 679s, *Department of the Air Force Publication Compliance Item Waiver Request/Approval* (PACAF Approvals are in **Figure A1014**).

A2.8. F-22 Markings.

Table A2.6. F-22 Markings.

Marking	Location	Size	Color/Finish
Tail Stripe	Horizontal wrap around stripe applied to the upper most elements on both sides of the vertical stabilizers.	6 inches tall	Any design applied in contrasting shades of gray
PACAF Command Patch	On both vertical stabs; Vertical: Top of insignia applied 50.3 inches below top of vertical stabilizer Horizontal: Centered on trailing edge aft unit designator letter	18 inches tall	Contrasting gray
Unit Unique Silhouette	Not authorized on F-22	N/A	N/A
Unit Identifier "AK"	On both sides of vertical stab; Vertical: Bottom of letters applied 96.1 inches below top of vertical stabilizer Horizontal: Bottom leading edge of first letter is applied 28.8 inches aft of vertical stabilizer leading edge	24 inches tall	Contrasting gray
Wing Patch	On left side of fuselage; Vertical: Centered between chine and bottom of the intake Horizontal: Centered between leading edge of right intake lip and right weapons bay	18 inches tall	Contrasting gray
Squadron Patch	On right side of fuselage; Vertical: Centered between chine and bottom of the intake Horizontal: Centered between leading edge of left intake lip and left weapons bay	18 inches tall	Contrasting gray
Pilot and Crew Chief Names	Pilot: Justified to forward edge of left nose landing gear door Crew Chief: Justified to forward edge of right nose landing gear door	1.75 inches tall	Per local Instruction

A2.9. F-35 Markings.

Table A2.7. F-35 Markings.

Marking	Location	Size	Color/Finish
Tail Stripe	Not authorized for F-35 aircraft	N/A	N/A
PACAF Command Patch	On both vertical stabs; Vertical: bottom centered 47 inches above the bottom edge of the blackboard Horizontal: Centered fore to aft in the vertical stabilizer blackboard area	12 inches tall	Contrasting gray silhouette
Unit Unique Silhouette	Not authorized for F-35 aircraft	N/A	N/A
Unit Identifier	On both sides of vertical stab; Vertical: Bottom of the designator will be centered 25 inches above the bottom edge of the vertical stabilizer blackboard. Horizontal: Centered on vertical stab, excluding rudder measurement	12 inches tall	Contrasting gray
Aircraft Tail Numbers	Bottom of the tail number will be centered 2 inches above the bottom edge and 2.6 inches from the inner most trailing edge corner of the vertical blackboard area.	6 inches tall	Contrasting gray
Wing Patch	Insignia will be centered within the blackboard area on the right side inlet below the chine and formation light.	12 inches tall	Contrasting gray silhouette
Squadron Patch	Insignia will be centered within the blackboard area on the left side inlet below the chine and formation light.	12 inches tall	Contrasting gray silhouette
Pilot and Crew Chief Names	Pilot: End of name will be located two inches forward of inboard aft apex (BL 0) and two inches from BL 0 door edge (left NLG door); Crew Chief: Beginning of name/rank will be located two inches forward of inboard aft apex (BL 0) and two inches from BL 0 edge (right NLG door).	2 inches tall	Per local Instruction

Marking	Location	Size	Color/Finish
Nose Numbers	Nose numbers will be located four inches from the inboard door forward apex (BL 0) and two inches from BL 0 door edge.	4 inches tall	Contrasting gray
<p>Note: All lettering/numbering applied to F-35 blackboard areas will meet vertical block type/style font/lettering and Arabic numerals as specified in Technical Order 1-1-8, Appendix B, Figure B-3 (Form of Letters and Numerals) or similar computer-generated font.</p>			

A2.10. HH-60 Markings.

Table A2.8. HH-60 Markings.

Marking	Location	Size	Color/Finish
PACAF Command Patch	Left side: 11 inches below WL 319.633 centered Right side: 7 inches below WL 319.633 centered	10 inches tall	Subdued
Unit Identifier	Left side: Positioned 21.5 inches below WL 319.633, centered Right side: Positioned 19 inches below WL 319.633, centered	9 inches tall	Subdued
Wing Patch	On right cargo door 8 inches below forward window, centered	10 inches tall	Subdued
Squadron Patch	On left cargo door, 8 inches below forward window, centered	10 inches tall	Subdued
Pilot and Crew Chief Names	Pilot: Right door, 2.5 inches below window, centered Copilot: Left door, 2.5 inches below window, centered Crew chief/assistant: Crew chief, right cargo door, 3.1 inches below and centered on forward window. Assistant: Left cargo door, 3.1 inches below and centered on forward window	Not to exceed 2 inches tall	Per local Instruction
Helicopter Rotor Markings	All helicopter rotor markings will be in accordance with T.O. 1-1-8 and applicable weapons system technical data.	T.O. 1-1-8 and applicable weapons system technical data	T.O. 1-1-8 and applicable weapons system technical data

A2.11. KC-135 Markings.

Table A2.9. KC-135 Markings.

Marking	Location	Size	Color/Finish
Tail Stripe	Horizontal wrap around stripe. Top of stripe located at WL 557.1	24 inches tall	Per local instruction
American Flag	On both sides of vertical stab; Center on vertical stabilizer with bottom of flag 79 inches above top of UHF antenna.	40 X 23 inches	See TO 1C-135-3-8
PACAF Command Patch	On both sides of vertical stab; Vertical: Top of patch 24 inches below bottom of tail stripe Horizontal: Leading edge of patch 17 inches from leading edge of tail	24 inches tall	Black silhouette
Unit Unique Silhouette (per local instruction)	On both sides of vertical stab; Vertical: Centered between PACAF command patch and unit identifier Horizontal: Centered on vertical stab, excluding rudder measurement	Not to exceed 24 inches tall x 36 inches wide	Per local instruction
Unit Identifier	On both sides of vertical stab; Locate 24 inches down from bottom of command emblem. Last letter of designator will end 17 inches in from leading edge of tail.	36 inches tall	Black
Aircraft Tail Numbers	On both sides of vertical stab; 6 inches below unit identifier	12 inches tall	Black
Wing Patch	Locate on left fuselage centered on Fuselage Station 360 & Water Line 214.	24 inches tall	Black silhouette
Squadron Patch	Locate on right fuselage centered on Fuselage Station 360 and Water Line 214. Insignia should be symmetrical with wing insignia.	24 inches tall	Black silhouette
Pilot and Crew Chief Names	See paragraph 5.5.10.	Not to exceed 2.5 inches tall	Per local Instruction
Nose Numbers	Last four digit of aircraft serial number. Start numbers on left fuselage at FS 277.0 with bottom of numbers on WL 200.0. Start numbers on right fuselage at FS 203.6 with bottom of numbers on	6 inches tall	Black

Marking	Location	Size	Color/Finish
	WL 200.0.		
Ruddervator Markings	Numeric and alpha designator of assigned squadron centered on the underside of the left and right ruddervator.	8 inches tall	36622

Attachment 3

DAILY SAS REPORTING METRIC

Figure A3.1. Daily SAS Reporting Metric.

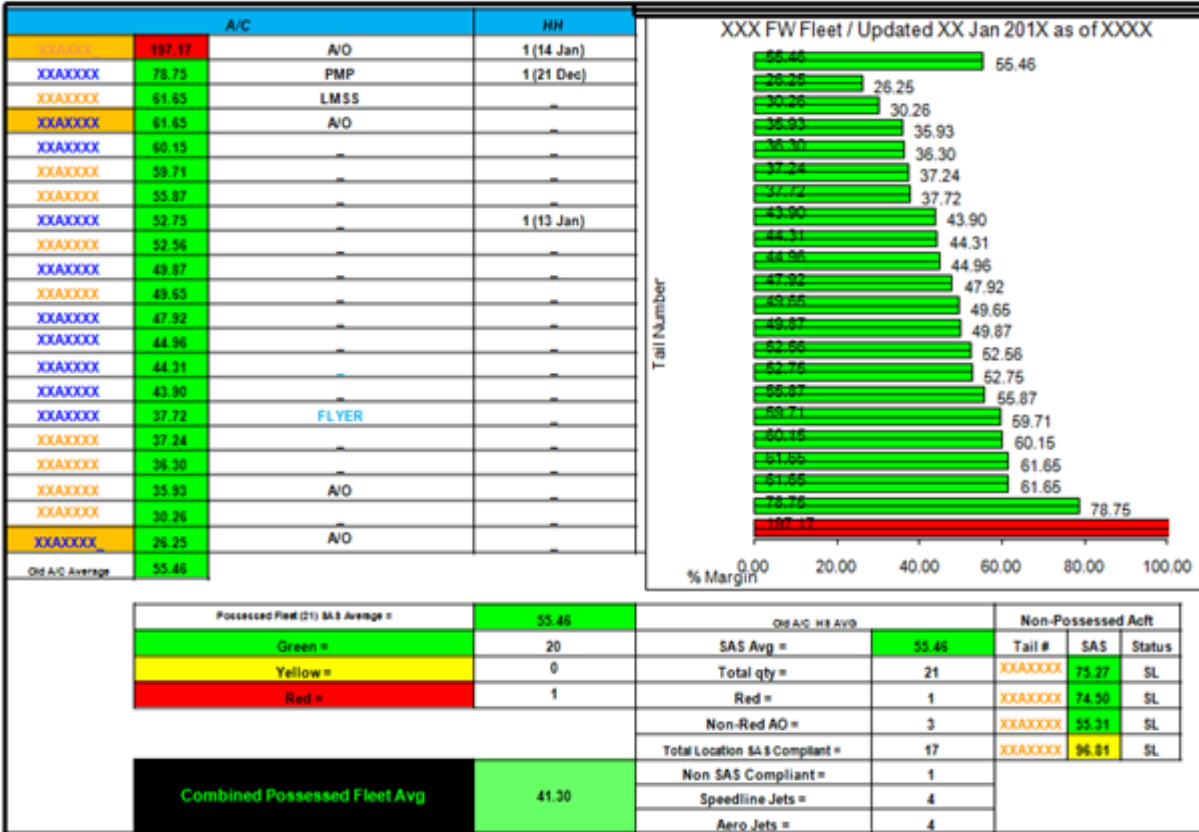

**Attachment 4
SAS AUDIT METRIC**

Figure A4.1. SAS Audit Metric.

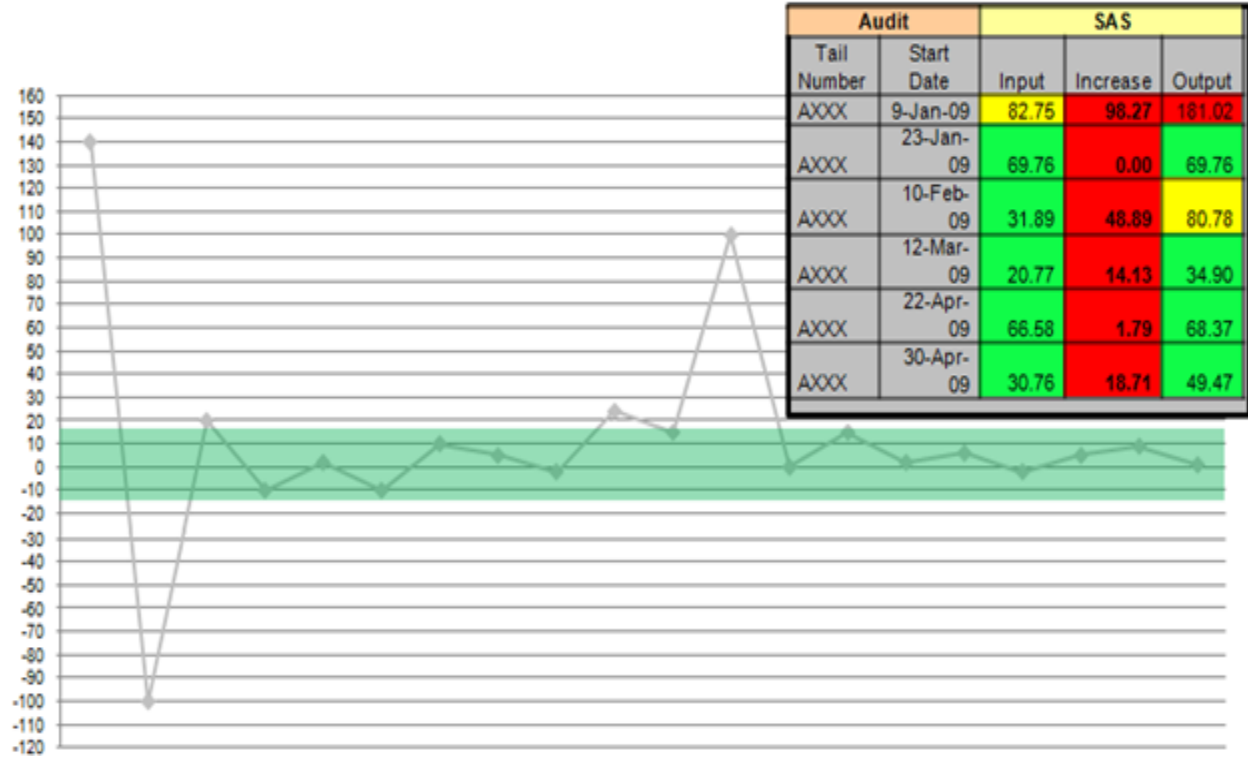

Attachment 5

SAS DAMAGE IMPACT DEFINITION

A5.1. The chart below shows a categorization approach to optimize maintenance activities. It outlines three categories of damages, those with an impact greater than 20% (major “spikes”), those between 2% and 20% (moderate “routine”) and those less than 2% (minor “creep”). Post flight OML inspections accomplished by the crew chief and/or LO personnel must identify any LO spike damages as soon as possible after flight if the aircraft is on the next day flying schedule.

Figure A5.1. SAS DAMAGE IMPACT CHART.

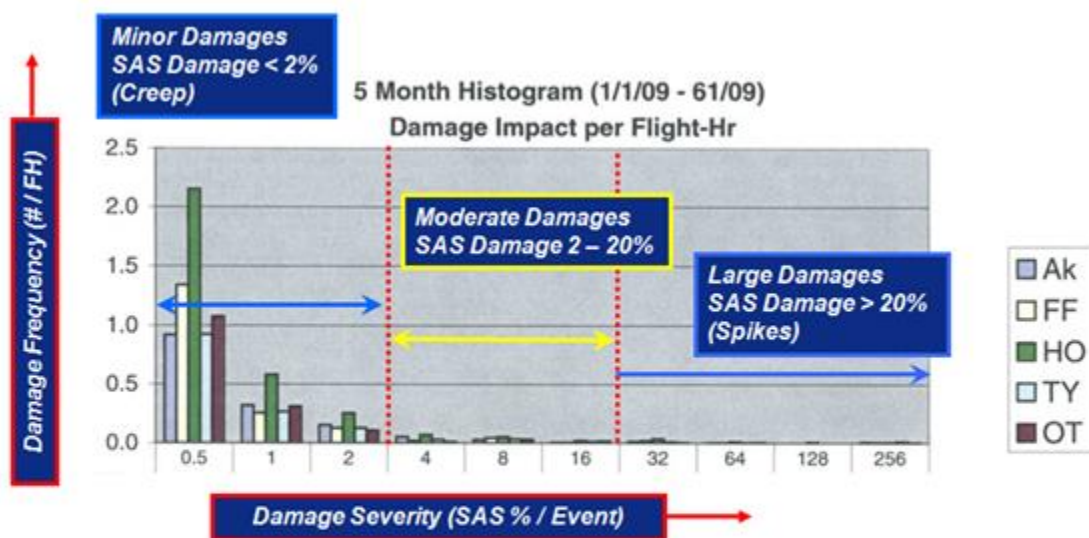

Note: Actual chart includes all data (including SAS creep rate) by base

SAS Creep = LO Damages 2% or Less

A5.1.1. The damage definition/SAS creep metric must be used to establish a battle rhythm for managing LO maintenance. Minor damages are repaired through scheduled SAS redux. Moderate damages should primarily be worked in groups in conjunction with other scheduled maintenance, e.g., Packaged Maintenance Plans, TCTOs, and panel removals to facilitate other maintenance. Any existing moderate damages should be the priority when performing scheduled SAS reduction efforts. Large damages that drive significant increases in SAS must be fixed as soon as possible to manage SAS growth. In some cases, it may be prudent to define large damages as >10 percent to effectively control SAS margins. This more aggressive approach is particularly beneficial prior to major deployments. Units have the option to define spikes as >10% if necessary to control spike growth, but the SAS creep definition provided above must be used in all cases.

A5.1.2. Use wing analysis and scheduling experts to help balance flying operations and LO maintenance events/downtime to best manage LO fleet health. Failure to effectively balance flying and LO maintenance requirements could lead to an uncontrollable LO backlog.

Attachment 6

LO MAINTENANCE SCHEDULE

Figure A6.1. LO Maintenance Schedule.

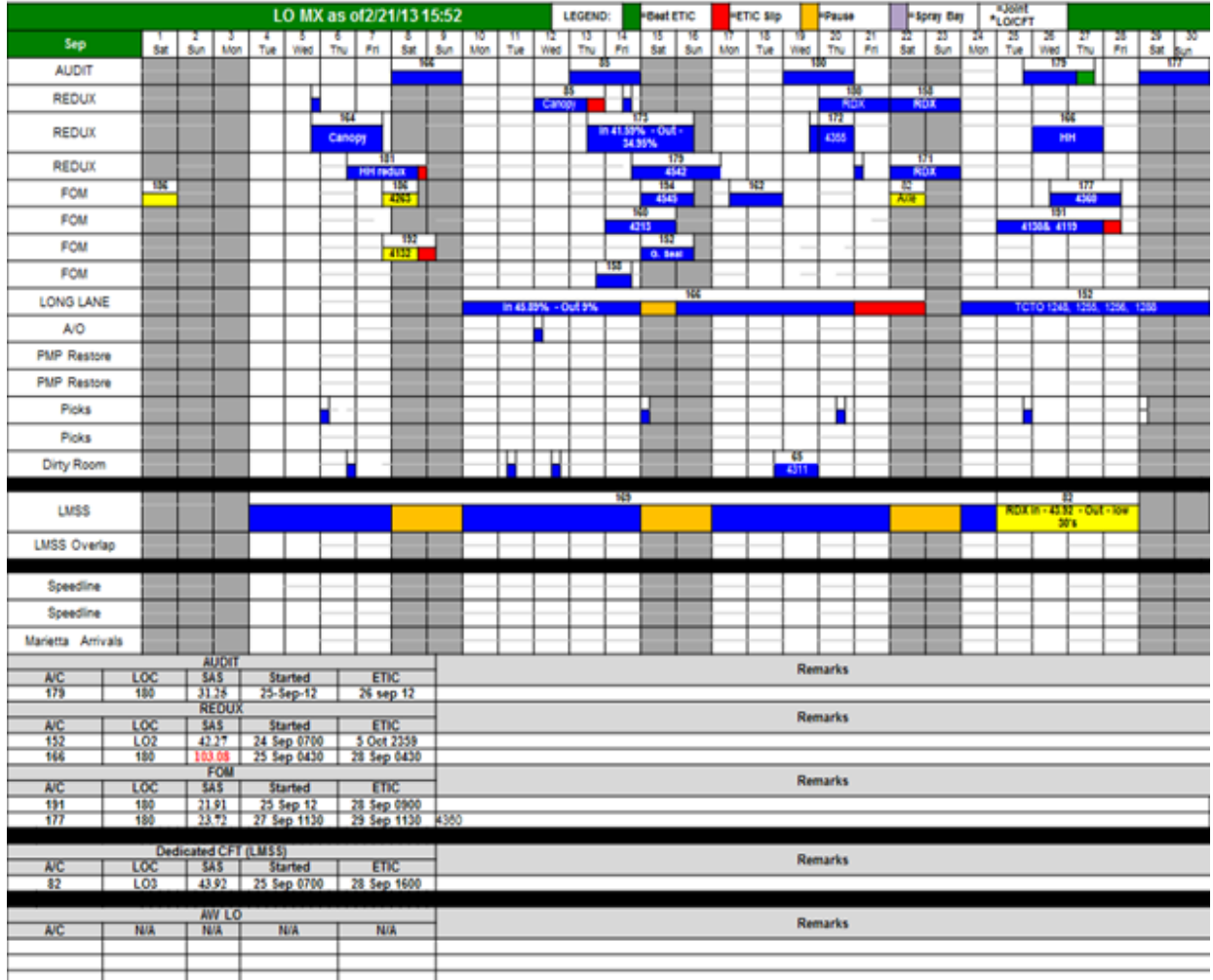

Attachment 7

CANOPY TRANSPARENCY STATUS REPORTING.

A7.1. Canopy transparency coating data is tracked by AF Engineering Technical Services, Field Service Representatives or Contract Engineering Technical Services in a format similar to the chart below. The tracking sheet must also include transparency manufacture and damage information by placing a flag note in each block used to track canopy hours. This data is tracked to help units predict reliability. Canopy data must be disseminated to MXG supervisors, MAJCOM weapon system team and the LM canopy IPT at least weekly.

Figure A7.1. Canopy Transparency Status Chart.

A/C	CANOPY HOURS	Visual Status	A/C	CANOPY HOURS	Visual Status	A/C	CANOPY HOURS	Visual Status	A/C	CANOPY HOURS	Visual Status
05-090	260.7	8	06-118	154.3	9	07-131	92.7		07-142	193	20
05-102	95.7		06-119	8.5	1	07-133	49.4		07-143	143	4
05-103	3.6		06-121	184.5	6	07-134	62.4		07-144	147.9	3
06-108	273	3	06-122	397		07-135	158		07-145	108.7	
06-110	73.5	2	06-123	192.9	12	07-136	85		07-146	214.1	6
06-112	76.3					07-137	23.8		07-147	293.1	15
06-113	189.1	4	06-126	148.7	2	07-138	179.4	2	07-148	283.8	10
06-114	380.3	10	06-127	112	5	07-139	75.7		07-149	139.8	2
06-115	152.6		06-129	114.5		07-140	167.7	25	07-150	96.7	2
06-117	111.3	1	06-130	58.8	1	07-141	119.4	6	07-151	173.7	31
Canopy Hours					Visual Status						
1-99.9 Hours					Major Visual Anomalies						
100 - 199.9 Hours					Minor Visual Anomalies						
200+ - Hours					No Visual Anomalies						
Number Inserted In Box = Repairs In Zone 1											

Attachment 8 (Added-8FW)
NON-COMMAND AIRCRAFT

A8.1. (Added-8FW) Non-command aircraft designations and markings not designated in Figure A8.1 are as follows:

A8.1.1. (Added-8FW) PACAF patch will be 11 inches by 10 inches, centered, 2 inches below tail stripe.

A8.1.2. (Added-8FW) 8th FW's "Wolf Head" will be centered, 5 inches below PACAF patch.

A8.1.3. (Added-8FW) WP will be 18 inches tall military block, centered, 5 inches below Wolf Head.

A8.1.4. (Added-8FW) Aircraft tail numbers will be 5 inches below Wolf Pack (WP).

Figure A8.1. (Added-8FW) Non-Command Aircraft.



Figure A8.2. (Added-8FW) Non-Command Aircraft Tail Number Measurements.



Attachment 9 (Added-8FW)

PAINT PLACARD

A9.1. (Added-8FW) Paint Placard will not exceed 6 x 6 inches and will match the color of other markings on the aircraft.

PAINTED:

Date: (DD,MMM,YY)

Activity & Cage Code: _____

Pretreatment: _____

Primer: _____

Topcoat: _____

Kunsan AB

Attachment 10 (Added-8FW)**COMMAND AIRCRAFT****A10.1. (Added-8FW) Command Aircraft designations and markings/locations are as follows: (See Figures A10.1 – A10.18):**

A10.1.1. (Added-8FW) Unit identifier will be centered, 4” military block font inside the tail stripe. The maximum length will be 41 inches.

A10.1.2. (Added-8FW) PACAF patch will be subdued, centered on tail, 2 inches below tail stripe.

A10.1.2.1. (Added-8FW) PACAF patch will also be centered inside sunburst for “Sunburst” design.

A10.1.3. (Added-8FW) Unit patches and “WP” will be centered on tail.

A10.1.4. (Added-8FW) Tail numbers will be centered, 1 inch above the base, with the forward lower corner being 9 inches from the leading edge seam.

A10.1.5. (Added-8FW) Unit chant will be centered, 6” military block font inside the tail base.

A10.1.6. (Added-8FW) “Panton Blue” will be 8 parts gray (color code 36270) to 5 parts blue (color code 35044) comprised of the same manufacturer until blue (color code 35095) is made available.

A10.2. (Added-8FW) 8 FW Command Aircraft designations and markings are as follows (See Figures A10.1 – A10.2):

A10.2.1. (Added-8FW) Tail markings will be flat white or gloss white (color codes 37925/17925).

A10.2.2. (Added-8FW) Camouflage pattern will be light green (color code 34102), brown (color code 30219), dark green (color code 34079).

A10.2.2.1. (Added-8FW) Dark green will be 8 parts light green (color code 34102) to 1 part flat black (color code 37038) comprised of the same manufacturer until dark green (color code 34079) is made available.

A10.2.3. (Added-8FW) The rudder design markings will be three alternating 2” blue (Panton Blue) and yellow (color code 33538) stripes.

A10.3. (Added-8FW) 8OG and 35FS Command Aircraft designations and markings are as follows (See Figures A10.1 – A10.18):

A10.3.1. (Added-8FW) Command Aircraft will have flat black (color code 37038) for tail stripe, base, and markings and match the tail/ventral fin (color code 36270 for two- tone/color code 36170 for monotone).

A10.3.2. (Added-8FW) The “Sunburst” design markings will be flat black (color code 37038), blue (Panton Blue), yellow (color code 33538), or red (color code 11136).

A10.3.3. **(Added-8FW)** The bottom sunburst stripe will terminate 1 inch above the tail numbers and 8 inches aft of the leading-edge seam. The remaining sunburst stripes will terminate in a 1 inch by 1 inch step pattern, heading upward and forward.

A10.3.4. **(Added-8FW)** Aircraft silhouettes will be centered on the rudder (See [Figure A10.3](#)).

A10.4. (Added-8FW) Command aircraft ventral fin markings are as follows (See Figure A11.4):

A10.4.1. **(Added-8FW)** 8 FW Command Aircraft will be painted dark green (color code 34079) with COL OLDS and SCAT XXVII annotated on them in.

A10.4.1.1. **(Added-8FW)** COL OLDS will be 2 1/2" Stencil Helvetica Med font in flat white or gloss white (color codes 37925/17925).

A10.4.1.2. **(Added-8FW)** SCAT will be 5". XXVII will be 3". Both will be in DIN Condensed Acet font in flat yellow (color code 33538).

A10.4.2. **(Added-8FW)** Command Aircraft will have a sunburst pattern with decorated pilots annotated on them. 1 3/4" Brush Script font, centered inside of the respective sunburst. Owing unit will provide the pilot names.

Figure A10.1. (Added-8FW) Command Aircraft Tail Designs Camouflage Measurements.



Figure A10.2. (Added-8FW) “Sunburst” Measurements.



Figure A10.3. (Added-8FW) 8th Operations Group.



Figure A10.4. (Added-8FW) 35th Fighter Squadron.



Figure A10.5. (Added-8FW) Unit Patches Circle Size.

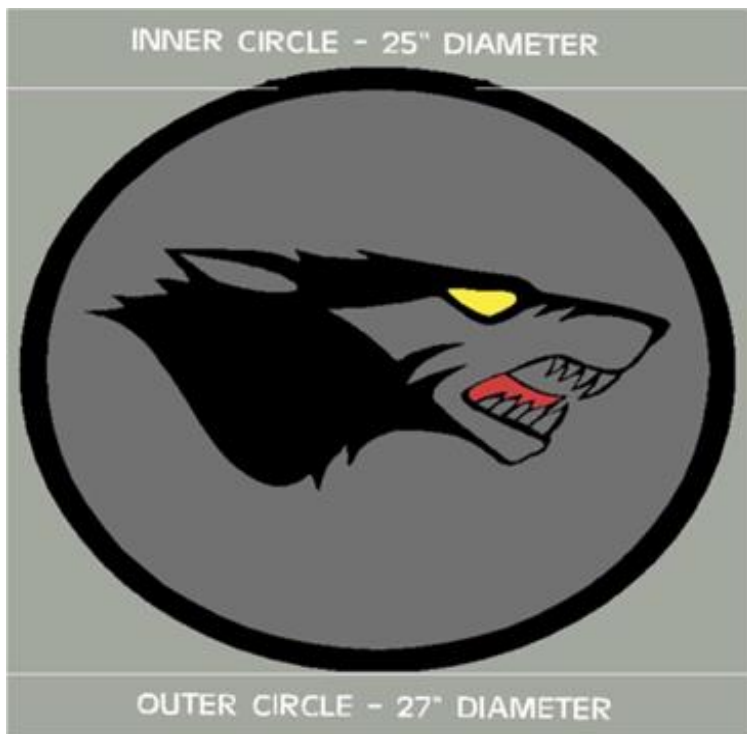

Figure A10.6. (Added-8FW) 8th Fighter Wing “Wolf Head”.



Figure A10.7. (Added-8FW) 8th Operations Group “Viper”.

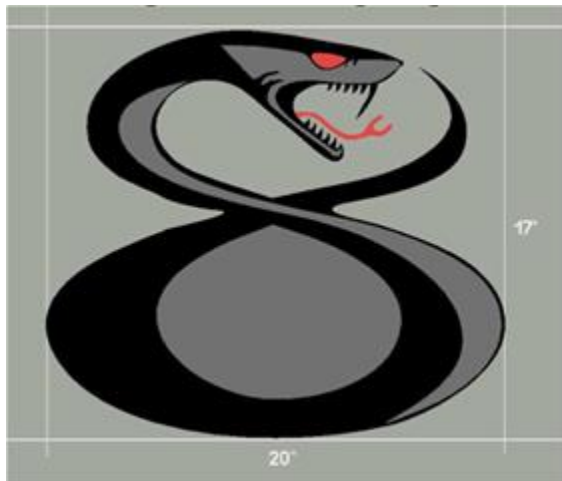

Figure A10.8. (Added-8FW) 35th Fighter Squadron “Panton”.

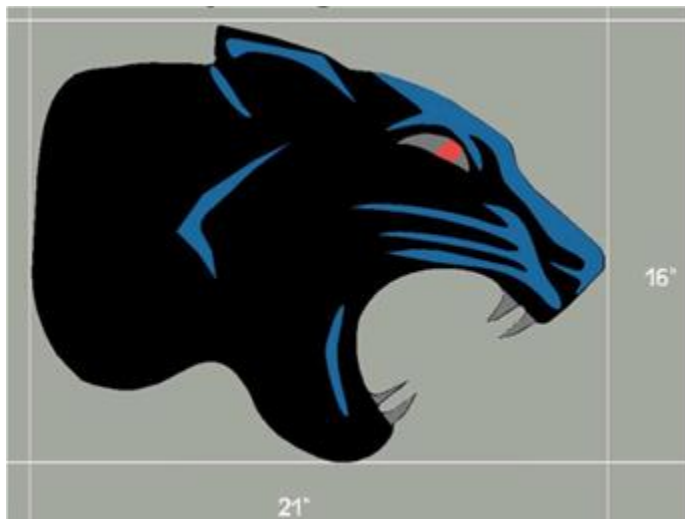

Figure A10.9. (Added-8FW) Command Aircraft Historical Tails Design Measurements.

F-104



F-105



F-102



F-100



F-4



F-86



F-80C



Figure A10.10. (Added-8FW) Ventral Fins 8th Fighter Wing.



Figure A10.11. (Added-8FW) Measurements.

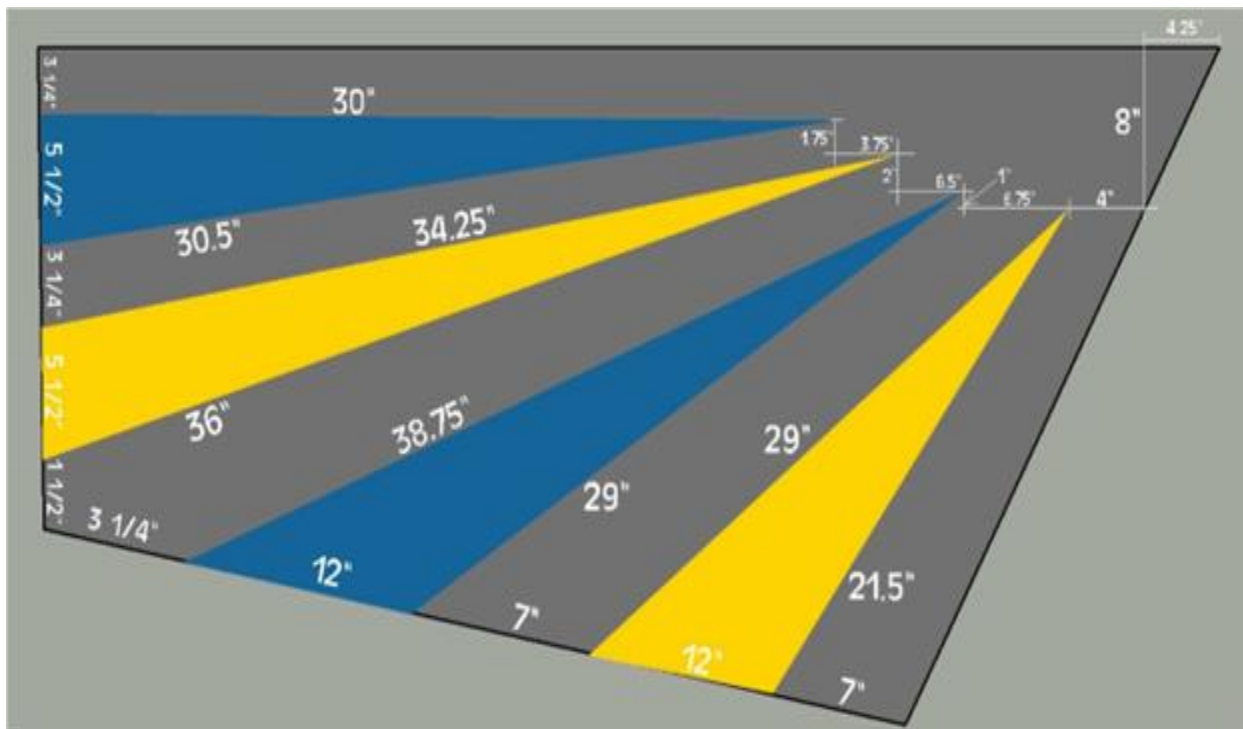

Figure A10.12. (Added-8FW) 8th Operations Group.

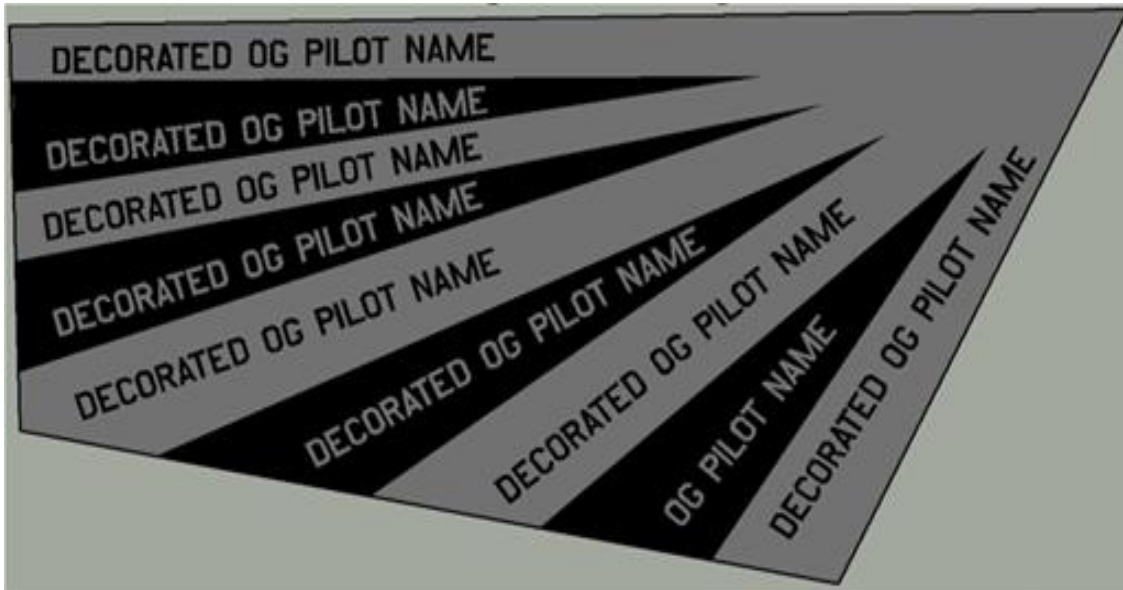

Figure A10.13. (Added-8FW) 35th Fighter Squadron.



Figure A10.14. (Added-8FW) Tail Flash Waiver Approvals, 8 FW Vietnam “Wolf 1” Camouflage, Signed.

AIR FORCE PUBLICATION COMPLIANCE ITEM WAIVER REQUEST/APPROVAL				
SECTION I: REQUESTING UNIT ACTIONS				
1. COMMANDER OR CIVILIAN LEADER OF UNIT REQUESTING WAIVER: Christopher B. Hammond	2. RANK/GRADE: Col / O-6	3. UNIT: 8 FW	4. DATE: 04-May-21	
5. TIER WAIVER NUMBER/AUTHORITY: (See AFI 33-360, Publications and Forms Management, paragraph 1.9. for more detailed guidance.) <input type="checkbox"/> NONE. Non-Tiered Requirements are processed and approved as directed in the specific publication. <input type="checkbox"/> TIER 0: Requirement external to AF. Requests for waivers must be processed through command channels to Publication OPR for consideration. <input type="checkbox"/> TIER 1: MAJCOM Commander (delegable no lower than the MAJCOM Director), with the concurrence of the publication's Approving Official. <input checked="" type="checkbox"/> TIER 2: MAJCOM Commander (delegable no lower than the first General Officer in the chain of command) <input type="checkbox"/> TIER 3: Wing/CRJL/FOA Commander (delegable no lower than Wing Commander or equivalent)				
6. PUBLICATION NUMBER AND TITLE: T.O. 1F-16CG-23 WP 007 00 / PACAFI 21-105 (FABRICATION PROGRAM)			7. DATE PUBLISHED: 03-Sep-20	
8. REQUIREMENT/COMPLIANCE ITEM: (Identify the specific paragraph number and text for which the commander/director is requesting a waiver) Section 5.5 Aircraft Mandatory Markings (Combat Aircraft), 5.12 Waivers, 5.12.1. "Wing Commanders must submit waiver requests to pacaf.a4mv3@us.af.mil." Table A2.5 F-16 Markings. "Not all inclusive, refer to specific weapon system T.O..." WP 007 paragraph 4. Aircraft Basic Colors "Using MAJCOM and ACC approval required prior to changing aircraft topcoat and/or color scheme configurations. Units will submit requests through their using MAJCOM to ACC A4/A8 for approval."				
9. RATIONALE: Explain how complying with the requirement/compliance item impacts mission accomplishment; cost of compliance creates unacceptable risk and/or cost of compliance outweighs benefit and/or personnel cannot comply due to lack of resources. The 8th Fighter Wing would like to pay homage to its impressive legacy by utilizing a modified version of the camouflage pattern made famous during the Vietnam War by Col Robin Olds for the wing commander's aircraft. Please see slide show presentation and PACAF 21-105_8FW Sup (Draft) per requirements listed in PACAFI 21-105 paragraph 5.12.1. Please NOTE: 8 FW is requesting that tail markings be either flat white or gloss white (color codes 37925/17925) for the Vietnam Era tail flash. This would be a deviation from PACAFI 21-105 Paragraph 5.2.2 & Table A2.6 "F-16 Markings."				
10. TIME PERIOD OR CIRCUMSTANCES FOR WHICH THE WAIVER WILL BE REQUIRED: This AF Form 679 requests approval to update the current paint scheme in accordance with PACAFI21-105 and WP 007 00 requirements for the 8th Fighter Wing Commander's aircraft, as an optional tail flash, in addition to the "sun burst" version recently approved by PACAF/A4.				
11. RISK MITIGATION MEASURE: Upon painting with the custom paint scheme, the aircraft will not be repainted again until it requires a repaint IAW normal guidelines. This will ensure no additional costs are required to repaint the aircraft.				
12. IMPACT OF DISAPPROVAL: Disapproval of this request will inhibit the 8 MXS from complying with leadership's intent to have an aircraft tail flash paint scheme to recognize the Wolf Pack's heritage.				
SECTION II: COORDINATION ACTIONS. Tier 1 waiver requests must have publications HAF approving official's concurrence prior to MAJCOM Commanders approval.				
ORG/OFFICE	ACTION	NAME, GRADE/RANK	SIGNATURE	DATE
8 FW/CC	Concur	Christopher B. Hammond, O-6/COL	HAMMOND-CHRISTOPHER 8 113806251	06-May-21
SECTION III: APPROVAL AUTHORITY AND EXPIRATION				
<input checked="" type="checkbox"/> WAIVER APPROVED - PERMANENT (A permanent waiver must be renewed within 30 days of the approving commander's change of command) <input type="checkbox"/> WAIVER APPROVED - TEMPORARY EXPIRATION DATE: <input type="checkbox"/> WAIVER DISAPPROVED				
13. WAIVER MODIFICATION:				
NAME, GRADE/RANK, ORG/OFFICE SYMBOL, TITLE OF APPROVING COMMANDER		SIGNATURE		DATE
ANDREW B. HUNTOON, Colonel, PACAF/A4M		HUNTOON-ANDRE W.B.1080358195		10-May-21

Figure A10.15. (Added-8FW) Tail Flash Waiver Approvals, “Heritage Sunburst” Design Approval Form, Signed.

AIR FORCE PUBLICATION COMPLIANCE ITEM WAIVER REQUEST/APPROVAL				
SECTION I: REQUESTING UNIT ACTIONS				
1. COMMANDER OR CIVILIAN LEADER OF UNIT REQUESTING WAIVER: Christopher B. Hammond	2. RANK/GRADE: Col /O-6	3. UNIT: 8 FW	4. DATE: 10-Feb-21	
5. TIER WAIVER NUMBER/AUTHORITY: (See AFI 33-360, Publications and Forms Management, paragraph 1.9. for more detailed guidance.) <input type="checkbox"/> NONE. Non-Tiered Requirements are processed and approved as directed in the specific publication. <input type="checkbox"/> TIER 0: Requirement external to AF. Requests for waivers must be processed through command channels to Publication OPR for consideration. <input type="checkbox"/> TIER 1: MAJCOM Commander (delegable no lower than the MAJCOM Director), with the concurrence of the publication's Approving Official <input checked="" type="checkbox"/> TIER 2: MAJCOM Commander (delegable no lower than the first General Officer in the chain of command) <input type="checkbox"/> TIER 3: Wing/DRLU/FOA Commander (delegable no lower than Wing Commander or equivalent)				
6. PUBLICATION NUMBER AND TITLE: PACAFI 21-105 (FABRICATION PROGRAM)/T.O. 1F-16CG-23 WP 007 00 (CORROSION CONTROL)			7. DATE PUBLISHED: 03-Sep-20	
8. REQUIREMENT/COMPLIANCE ITEM: (Identify the specific paragraph number and text for which the commander/director is requesting a waiver) Section 5.5 Aircraft Mandatory Markings (Combat Aircraft), 5.12 Waivers, 5.12.1, "Wing Commanders must submit waiver requests to pacaf.a4mv3@us.af.mil." Table A2.5 F-16 Markings. "Not all inclusive, refer to specific weapon system T.O..." WP 007 paragraph 4. Aircraft Basic Colors "Using MAJCOM and ACC approval required prior to changing aircraft topcoat and/or color scheme configurations. Units will submit requests through their using MAJCOM to ACC A4/A8 for approval."				
9. RATIONALE: Explain how complying with the requirement/compliance item impacts mission accomplishment; cost of compliance creates unacceptable risk and/or cost of compliance outweighs benefit and/or personnel cannot comply due to lack of resources. The 8th Fighter Wing would like to celebrate its historical past by utilizing a modified version of the "heritage sunburst" tail flash made famous during the Korean War for our four Commander Aircraft. Please see slide show presentation and PACAFI 21-105_8FW Sup (Draft).				
10. TIME PERIOD OR CIRCUMSTANCES FOR WHICH THE WAIVER WILL BE REQUIRED: This AF Form 679 requests approval to update the current paint scheme in accordance with PACAFI21-105 and WP 007 00 requirements for the 8th Fighter Wing Commander's Aircraft, 8th Operations Group Commander's Aircraft, 35th Fighter Squadron Commander's Aircraft and 80th Fighter Squadron Commander's Aircraft.				
11. RISK MITIGATION MEASURE: Upon painting with the custom paint scheme, the aircraft will not be repainted again until it requires a repaint IAW normal guidelines. This will ensure no additional costs are required to repaint the aircraft.				
12. IMPACT OF DISAPPROVAL: Disapproval of this request will inhibit the 8 MXS from complying with leadership's intent to have heritage aircraft paint schemes in individual squadrons.				
SECTION II: COORDINATION ACTIONS. Tier 1 waiver requests must have publications HAF approving official's concurrence prior to MAJCOM Commanders approval.				
ORG/OFFICE	ACTION	NAME, GRADE/RANK	SIGNATURE	DATE
8 FW/CC	Concur	Christopher B. Hammond, O-6/Col	HAMMOND CHRISTOPHER 20210210 14:00:00 B.113815391	28-Feb-21
SECTION III: APPROVAL AUTHORITY AND EXPIRATION				
<input checked="" type="checkbox"/> WAIVER APPROVED - PERMANENT (A permanent waiver must be renewed within 30 days of the approving commander's change of command) <input type="checkbox"/> WAIVER APPROVED - TEMPORARY EXPIRATION DATE: <input type="checkbox"/> WAIVER DISAPPROVED				
13. WAIVER MODIFICATION:				
NAME, GRADE/RANK, ORG/OFFICE SYMBOL, TITLE OF APPROVING COMMANDER		SIGNATURE		DATE
ANDREW B. HUNTOON, Colonel, PACAF/A4M		HUNTOON ANDRE W.B.1080358195 Digitally signed by HUNTOON ANDREW B. 1080358195 Date: 2021.03.03 17:53:38 -0500		03-Mar-21