



AIR FORCE HANDBOOK 10-222, VOLUME 12
23 April 2009

GUIDE TO BARE BASE MECHANICAL SYSTEMS



DEPARTMENT OF THE AIR FORCE

BY ORDER OF THE SECRETARY OF THE AIR FORCE **AIR FORCE HANDBOOK 10-222, VOLUME 12**
23 April 2009

Certified Current, 8 March 2012

Operations



GUIDE TO BARE BASE MECHANICAL SYSTEMS

ACCESSIBILITY: Publications and forms are available on the e-Publishing web site at www.epublishing.af.mil for downloading or ordering.

RELEASABILITY: There are no releasability restrictions.

OPR: HQ AFCESA/CEXX
Supersedes AFH 10-222V12,
1 September 1999

Certified by: HQ AF/A7CX
(Colonel Donald L. Gleason)
Pages: 103

This handbook contains guidance on setting up and operating mechanical systems commonly encountered during bare base operations. It addresses, as appropriate, site selection and layout, major components, setup, operation, and shutdown of the M-80 Water Heater; Advanced Design Refrigerator, 300 Cubic Foot (ADR-300); Field Deployable Environmental Control Unit (FDECU); and the 130K Portable Heater. When coupled with information contained in the applicable technical orders and Air Force Pamphlet (AFPAM) 10-219, Vol 5, *Bare Base Conceptual Planning Guide*, and instruction received at Silver Flag training sites, personnel should be capable of effectively setting up and operating the equipment under contingency conditions. This publication applies to all Air Force active duty, Air National Guard (ANG), and Air Force Reserve Command Civil Engineer units. It supports Air Force Instruction (AFI) 10-209, *RED HORSE Program*, and AFI 10-210, *Prime Base Engineer Emergency Force (BEEF) Program*. Refer recommended changes and questions about this publication to the Office of Primary Responsibility (OPR) using the AF IMT 847, *Recommendation for Change of Publication*; route AF IMTs 847 from the field through Major Command (MAJCOM) publications/forms managers. Ensure that all records created as a result of processes prescribed in this publication are maintained in accordance with Air Force Manual (AFMAN) 33-363, *Management of Records*, and disposed of in accordance with the Air Force Records Disposition Schedule (RDS) located at

<https://www.my.af.mil/gcss-af61a/afrims/afrims/>. The use of the name or mark of any specific manufacturer, commercial product, commodity, or service in this publication does not imply endorsement by the Air Force.

SUMMARY OF CHANGES

This publication has been substantially revised and must be completely reviewed. With the exception of the M-80 Water Heater, all other bare base mechanical systems previously addressed in this publication have been removed. Items added include the ADR-300 Refrigerator, Field Deployable Environmental Control Unit, and the 130K Portable Heater.

Chapter 1—INTRODUCTION	8
1.1. General Information.....	8
1.2. Overview.....	8
Figure 1.1. Bare Base Mechanical Systems.....	8
1.3. Safety.....	9
1.4. Additional Information.....	10
Chapter 2—M-80 WATER HEATER	11
2.1. General Information.....	11
Figure 2.1. M-80 Heater.....	11
2.2. Characteristics and Features.....	11
Table 2.1. M-80 Operating Fuel Types.....	12
Figure 2.2. Select Fuel System Components.....	12
Figure 2.3. Drum Fill Adapter and Flexible Hoses on Fuel Cans.....	13
Figure 2.4. Sample Power Cable Assembly Connection.....	13
Figure 2.5. Burner Head Assembly.....	14
Figure 2.6. Sparkplug Electrodes.....	14
Figure 2.7. Ignition Cables, Transformer, Control Box, and Vessel.....	15
Figure 2.8. Blower Assembly.....	16
Figure 2.9. Sight Glass Assembly.....	16

Figure 2.10. Operating Control and Water Temperature Gauge	17
Figure 2.11. Upper Manifold Assembly.....	18
Figure 2.12. Lower Manifold Assembly	18
Figure 2.13. Portable Water Pump with Hoses	19
2.3. Set-Up Procedures.....	19
Figure 2.14. Expedient Drum Float Water Intake	21
Figure 2.15. Expedient Log Float Water Intake.....	21
Figure 2.16. M-80 Water Hose Connections.....	22
Figure 2.17. Elbow and Smoke Stack with Guard Assembly.....	23
Figure 2.18. Smoke Stack Bracket Screw	23
Figure 2.19. Fuel Line Connections to Drum Fill Adapter	24
Figure 2.20. Electrical Connections	25
Figure 2.21. Pump Motor Rotation Direction	26
Table 2.2. M-80 –Before Operation” PMCS.....	27
Figure 2.22. Water Heater Power Switch.....	28
Figure 2.23. Manual Fuel Shut-Off Valve.....	28
Figure 2.24. Reset Button on Flame Safeguard Control.....	29
Figure 2.25. Blower Air Shutter.....	29
Figure 2.26. Fuel Pump Primer Plug.....	30
Figure 2.27. Water Heater Drain Cock.....	31
Figure 2.28. Fuel Pump Motor Rotation Direction	32
2.4. Operation.....	32
Table 2.3. M-80 –During Operation” PMCS.....	34
2.5. Shutdown Procedures.....	34
2.6. Preparation for Storage or Shipment	35
Figure 2.29. Fuel Line Stowage Position	35

Chapter 3—ADVANCED DESIGN REFRIGERATOR, 300 CUBIC FOOT (ADR-300)37

 3.1. General Information37

 Figure 3.1. ADR-300..... 37

 3.2. Characteristics and Features37

 Figure 3.2. ADR-300 Features (Front View) 38

 Figure 3.3. Interior Floor Drain..... 39

 Figure 3.4. Exterior Drain Plug 39

 Figure 3.5. Tie-Down Rings 40

 Figure 3.6. Light Fixture and Switch 41

 Figure 3.7. Plunger 41

 Figure 3.8. Refrigeration Unit Features..... 42

 Figure 3.9. Evaporator Unit Protrudes Inside Container 43

 Figure 3.10. Controller Display and Keypad..... 43

 Table 3.1. Display and Keypad References..... 44

 3.3. Set-Up Procedures.....45

 Figure 3.11. Built-In Forklift Pockets 45

 Figure 3.12. Installation of Refrigeration Unit with a Forklift 46

 Figure 3.13. Power Supply Cable Connection to Refrigeration Unit 47

 Figure 3.14. Container Power Supply Cord Connection 48

 3.4. Operation.....48

 Table 3.2. ADR-300 –Before Operation” PMCS 49

 Figure 3.15. Controller Removal..... 53

 Figure 3.16. Opened Back Cover on Controller 54

 Figure 3.17. Dip Switch 3 in Down/OFF (Fahrenheit) Position..... 54

 Table 3.3. ADR-300 Operational PMCS..... 55

 Table 3.4. ADR-300 Lubrication Requirements 55

3.5. Shutdown Procedures.....	57
3.6. Preparation for Storage or Shipment.....	57
Chapter 4—FIELD DEPLOYABLE ENVIRONMENTAL CONTROL UNIT (FDECU).....	61
4.1. General Information.....	61
Figure 4.1. Field Deployable Environmental Control Unit (FDECU).....	61
4.2. Characteristics and Features.....	61
Figure 4.2. FDECU Major Components.....	62
Figure 4.3. Master Control Panel.....	63
Figure 4.4. Remote Control Panel and Cable Routed Inside Shelter.....	63
Figure 4.5. Sight Glass (or Liquid Refrigerant Indicator).....	64
Figure 4.6. Replaceable Air Filter Located Inside Return Air Flange.....	65
Figure 4.7. Supplemental Electric Resistance Heaters.....	65
4.3. Set-Up Procedures.....	66
Figure 4.8. Siting FDECU.....	66
Figure 4.9. FDECU Sample Configuration.....	67
Figure 4.10. Unpacked FDECU Components.....	68
Figure 4.11. Hair Cotter Pin Installation.....	69
Figure 4.12. Return Air Flange Assembly Removal.....	69
Figure 4.13. Removal of Shipping Cover from Return Air Volute.....	70
Figure 4.14. Loosen Supply Panel Screws.....	71
Figure 4.15. Removal of Quick Release Pins on Heater Barrel.....	71
Figure 4.16. Perforated Holes and Clamps on Return Air Flange.....	73
Figure 4.17. FDECU Connected to 208 Volts AC Power Supply.....	73
4.4. Operation.....	74
Table 4.1. FDECU “Before Operation” PMCS.....	74
Table 4.2. Weekly PMCS.....	75

Table 4.3. Monthly PMCS	75
Figure 4.18. Control Selection Toggle Switch (FDECU-2 Panel)	76
Table 4.4. FDECU “During Operation” PMCS	78
4.5. Shutdown Procedures.....	79
4.6. Preparation for Storage or Shipment	79
Chapter 5—130K MULTI-FUELED, PORTABLE HEATER	82
5.1. General Information	82
Figure 5.1. 130K Heater	82
5.2. Characteristics and Features.....	82
Figure 5.2. External Features	84
Figure 5.3. Internal Features	85
Figure 5.4. External Thermostat and CO Monitor	86
Figure 5.5. Heater Control Panel.....	87
Table 5.1. 130K Heater Control Panel Components and Function	88
Table 5.2. Heater Control Panel Display Messages	89
5.3. Set-Up Procedures.....	90
Figure 5.6. 130K Heater Sited Near Tent.....	90
Figure 5.7. Exhaust Extension (Stack) Installation	91
Table 5.3. 130K Heater Operating Fuel Types.....	92
Figure 5.8. Fuel Three-Way Valve Positions	92
Figure 5.9. Air Duct Connection	93
Figure 5.10. Fresh Air Adjustment.....	93
5.4. Operation.....	95
Table 5.4. Heat Control Switch Settings	96
5.5. Shutdown Procedures.....	96
5.6. Preparation for Storage or Shipment	96

Figure 5.11. Fuel Tank Drain	97
Figure 5.12. Ducts Secured with Hook and Loop	97
Figure 5.13. Adapter Cover Installation	98
Chapter 6—INFORMATION COLLECTION, RECORDS, AND FORMS	99
6.1. Information Collections	99
6.2. Records	99
6.3. Forms (Adopted and Prescribed).....	99
Attachment 1—GLOSSARY OF REFERENCES AND SUPPORTING INFORMATION	100



Chapter 1

INTRODUCTION

1.1. General Information. This handbook addresses procedures used to set up and operate the M-80 Water Heater; Advanced Design Refrigerator, 300 Cubic Foot (ADR-300); Field Deployable Environmental Control Unit (FDECU); and the 130K Multi-Fuel Portable Heater (**Figure 1.1**). It is meant to be used by civil engineer heating, ventilation, air conditioning, and refrigeration (HVAC/R) personnel in performing their beddown and sustainment mission taskings under contingency conditions. Users of this handbook should have a basic knowledge of bare base assets and their functions—readers without this fundamental knowledge should review the references in **Attachment 1** and contact their unit’s training manager for training options.

1.2. Overview. The information presented here is designed to augment, not replace, technical orders for bare base mechanical systems. It highlights general characteristics, setup, and basic operating procedures. Personnel should refer to applicable technical orders for more detailed information, including maintenance, troubleshooting, and repair of these systems.

Figure 1.1. Bare Base Mechanical Systems.



1.3. Safety. Complying with proper safety procedures is vital when setting up and operating bare base mechanical systems. The flammable fuels and lethal voltages used in the operation of many of these systems are significant hazards, and adherence to all technical order warnings is critical to avoid personal injury or death. Furthermore, the dangers associated with maintaining systems that use lethal voltages make it imperative that the techniques and procedures outlined in AFI 32-1064, *Electrical Safe Practices*, be applied at all times. Below are some general warnings that pertain to many of the bare base mechanical systems currently in use:

WARNING

Dangerous and lethal voltage is used in the operation of many bare base mechanical systems. Make sure power supply circuit breakers are in the OFF position before connecting or disconnecting the power supply. Failure to comply may result in serious injury or death to personnel.

WARNING

Do not wear metal frame glasses, rings, watches or other metal jewelry while working on electronic equipment.

WARNING

Lethal voltage is present when mechanical systems are connected to a power source. Disconnect from power source before inspecting or repairing any electrical component. Be careful not to touch electrical connections. Electrical shock and/or death may result from failure to heed this warning.

WARNING

Fuel used with these systems is highly flammable and may cause severe burns or death if handled improperly.

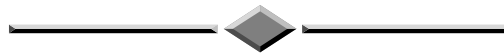
WARNING

Exposed fuel and fuel vapor can ignite or explode, resulting in possible serious injury or death. Observe proper safety precautions when servicing the fuel system.

WARNING

Mechanical systems are heavy and require an appropriate lifting device to move. Personal injury can result if moved without the aid of a lifting device.

1.4. Additional Information. The siting and installation of some bare base mechanical systems may be impacted by the facilities they support; i.e., shower/shave units, personnel tents, kitchens, or laundry facilities. Personnel should review technical orders for these facilities when attaching or integrating bare base mechanical systems. In addition, contact the Air Force Civil Engineer Support Agency (AFCESA) Reach-Back Center if you are looking for information not found in this publication or the references in **Attachment 1**. Call the Reach-Back Center at 888-232-3721 (commercial), DSN 523-6995, or email at afcesareachbackcenter@tyndall.af.mil.



Chapter 2

M-80 WATER HEATER

2.1. General Information. The M-80 water heater (**Figure 2.1**) is the primary method of providing hot water at a bare base. It is used to supply hot water to bare base facilities, such as kitchens, shower and shave units, and laundry and medical facilities. It fulfills a critical sanitation need in addition to improving morale at austere locations. Operators and maintainers should observe all technical order warnings and cautions to ensure safe operation of the water heater and all associated equipment.

Figure 2.1. M-80 Water Heater.



2.2. Characteristics and Features. The water heater is a skid-mounted, self-contained, liquid fuel-fired boiler. It will operate on several types of fuel; including diesel, jet fuel, or fuel oil (**Table 2.1**). The heater also uses 208-volt, three-phase power (generator or commercial power) to operate its blower and fuel pump. The supporting water pump (not a component of the M-80) also uses this power source. The water heater delivers water at a rate of approximately 9 gallons per minute (gpm) at temperatures between 100° Fahrenheit (F) and 190° F. Water enters and exits the vessel through separate manifolds, and the water supply can be from natural sources such as

lakes, rivers, or bare base and commercial water distribution systems. Safety features include an automatic flame safeguard control system and an audio alarm that alerts the operator when a low fuel condition or loss of flame occurs. Although the M-80 itself is relatively small, it is very heavy and requires a forklift to position the unit. In its crated configuration, the heater weighs approximately 1,065 pounds. Even when unpacked, the heater still weighs approximately 465 pounds. Prominent features of the heater consist of the following systems, subassemblies, and supporting equipment items.

Table 2.1. M-80 Operating Fuel Types.

Fuel Types	
Diesel	VV-F-800, DF-A, DF-1, DF-2
Jet Fuel	MIL-T-5624 JP-4, JP-5
Jet Fuel	MIL-T-83133, JP-8
Fuel Oil	Commercial Fuel No. 2

2.2.1. **Fuel System.** The fuel system includes components such as the fuel pump, filter, shutoff valve, gauges, and supply hoses (**Figure 2.2**). Fuel is commonly provided in 55-gallon drums (5-gallon jerry cans can be used) and fed to the heater through the drum fill adapter and flexible hose assembly (**Figure 2.3**). Excess fuel returns through a fuel return hose connected to the bottom of the fuel pump and the return fitting on the drum fill adapter.

Figure 2.2. Select Fuel System Components.

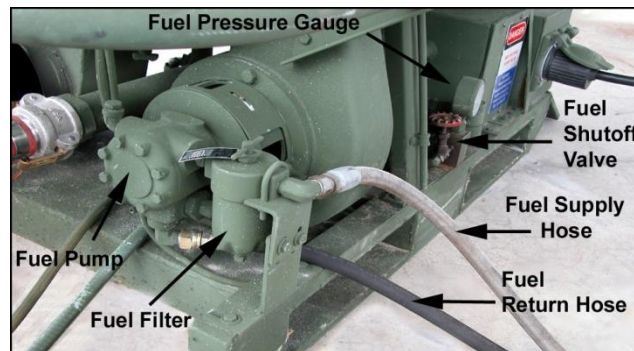
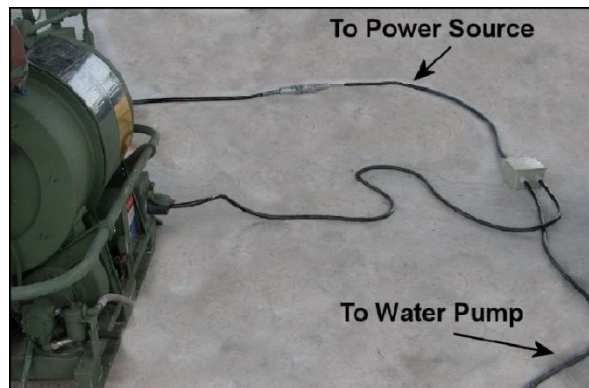


Figure 2.3. Drum Fill Adapter and Flexible Hoses on Fuel Cans.



2.2.2. Power System. Electrical power to the M-80 water heater is supplied from an external power source through a power cable assembly that extends from a power distribution panel or generator. The power cable assembly is part of the bare base kitchen, shower, laundry, and medical facilities and typically consists of a dual-junction power cable that connects the power source to the water heater and supporting water pump (**Figure 2.4**).

Figure 2.4. Sample Power Cable Assembly Connection.



2.2.3. **Burner Head Assembly.** The burner head assembly (**Figure 2.5**) at the center of the combustion chamber serves as a mounting platform for the fuel nozzle, two sparkplug electrodes, the burner assembly sight glass, and the ultraviolet (UV) or infrared (IR) scanner that is part of the flame safeguard control system. When the power switch is activated, the sparkplug electrodes (**Figure 2.6**) are energized to ignite the fuel mixture from the fuel nozzle to heat the water.

Figure 2.5. Burner Head Assembly.

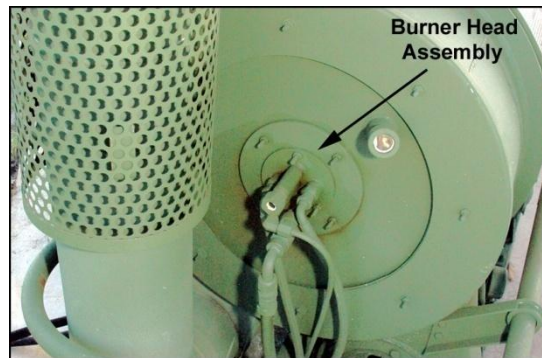
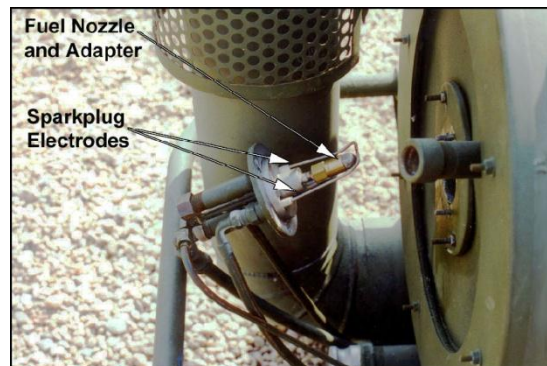


Figure 2.6. Sparkplug Electrodes. (Exposed to show configuration only)

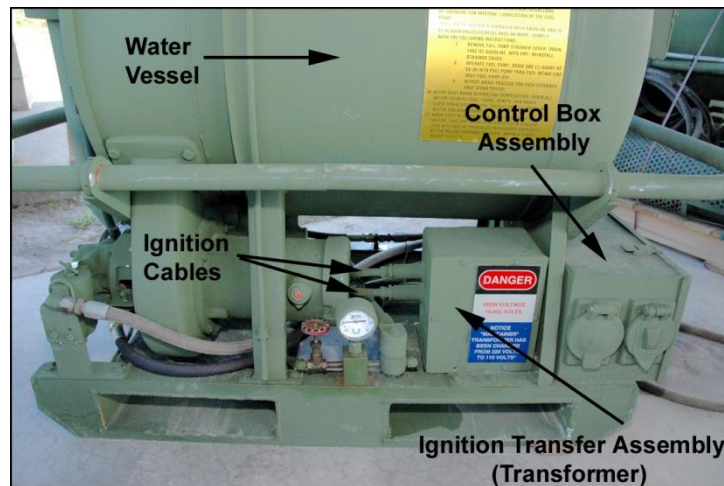


2.2.4. Ignition Transfer Assembly and Ignition Cables. The ignition transfer assembly is where the transformer is located, and the ignition cables lead from the transformer to the sparkplug electrodes (**Figure 2.7**). The transformer provides the voltage needed to fire the electrodes.

2.2.5. Control Box Assembly. The control box (**Figure 2.7**) contains most of the electrical contacts, relays, switches, and controls for the heater, including the power switch and twist-lock receptacle, motor contactor reset, flame failure alarm, and hour meter.

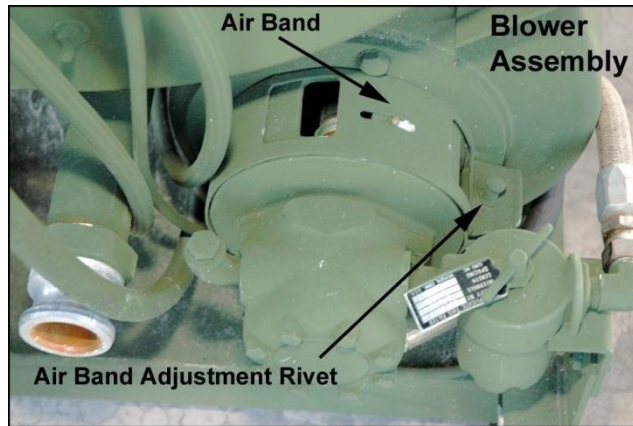
2.2.6. Water Vessel. The water vessel (**Figure 2.7**) contains the water being heated. It holds approximately 24 gallons.

Figure 2.7. Ignition Cables, Transformer, Control Box, and Vessel.



2.2.7. Blower Assembly. The blower assembly (**Figure 2.8**) provides and controls airflow to the burner. The amount of air is controlled by an adjustable shutter assembly on the blower. The shutter assembly consists of an air band and air band adjustment rivet.

Figure 2.8. Blower Assembly.



2.2.8. **Sight Glass Assembly.** Two sight glasses (**Figure 2.9**) are on the M-80 heater. One is for visually inspecting flame in the combustion chamber and the other is to check firing of the sparkplug electrodes.

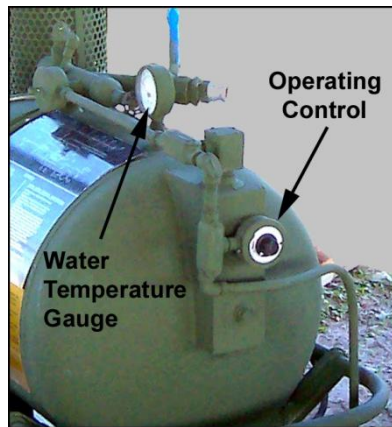
Figure 2.9. Sight Glass Assembly.



2.2.9. Operating Control and Water Temperature Gauge (Figure 2.10).

The operating control is used to set the desired water temperature. Although the control has a calibrated scale ranging from 0° F to 250° F, it actually regulates the burner to maintain the water temperature between 100° F and 190° F. The water temperature gauge indicates the temperature of the water inside the water heater.

Figure 2.10. Operating Control and Water Temperature Gauge.



2.2.10. Upper Manifold Assembly. The upper manifold (**Figure 2.11**) includes the hot water output valve, valve vent, pressure relief valve, and high limit control. The hot water output valve controls the flow of hot water from the upper manifold and through the hot water supply hose. The vent valve is used to bleed air from the water heater. The pressure relief valve activates and relieves the pressure when the internal temperature exceeds the prescribed limit. Lastly, the high limit control deactivates the fuel solenoid valve when the water temperature exceeds 190° F.

2.2.11. Lower Manifold Assembly. The lower manifold (**Figure 2.12**) serves as the water intake point of the heater to which the water hose is connected.

Figure 2.11. Upper Manifold Assembly.

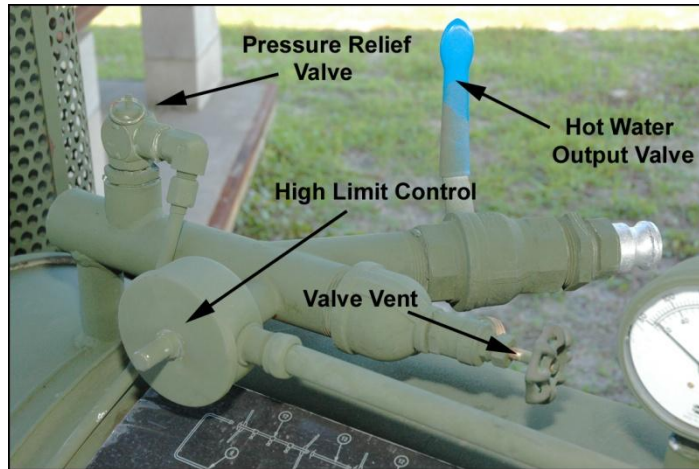
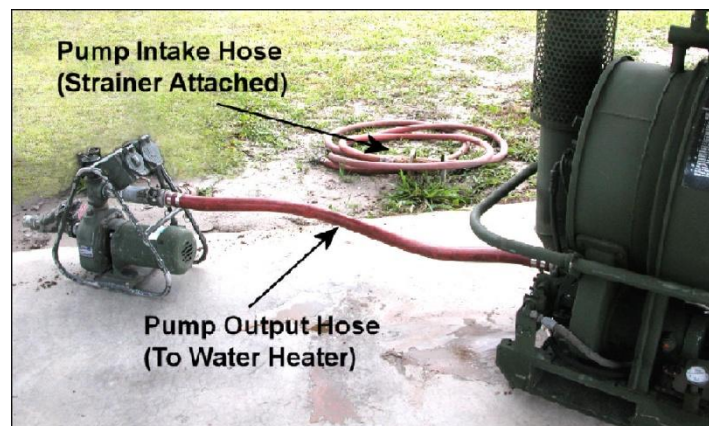


Figure 2.12. Lower Manifold Assembly.



2.2.12. **Water Pump.** The portable water pump is supporting equipment and is not a component of the M-80 water heater. It is usually packaged with bare base shower, kitchen, laundry, and medical facilities. The pump is electrically driven and draws water from sources such as lakes and rivers, water bladders, and other base water distribution sources. A water hose with a 1-inch inside diameter attaches to the intake side of the pump and serves as the suction line from the water source. With surface water sources like lakes, streams, or rivers, the suction hose is equipped with a strainer assembly on the end to prevent entry of debris. The pump connects to the water heater using a 6-foot long, 1-1/2 inch inside diameter hose (Figure 2.13).

Figure 2.13. Portable Water Pump with Hoses.



2.3. **Set-Up Procedures.** The siting and installation of the water heater unit should be according to specifications of the supported facility; i.e., shower/shave unit, kitchen, or laundry. In many cases, siting and installation will be further impacted by the type of water source used and the equipment available. For example, Basic Expeditionary Airfield Resources (BEAR) sets have different pumps and hoses that may require special siting and installation procedures. Regardless of the water source or equipment used, attempt to locate the water heater away from avenues of pedestrian traffic and far enough away from its supported facility to permit ready

access for operation, maintenance, and refueling. Also, ensure drainage flows away from the heater once a final location is selected. The following paragraphs address other fundamental procedures for setting up the water heater and associated equipment.

WARNING

Be sure that fuel lines do not touch or cross water hoses, power cable, or exhaust duct. Melting/damage can occur, causing leaking fuel and water or electrical hazards. Death by electrocution, fire, or explosion could result.

2.3.1. **Connect Water Pump to Water Source.** Use the following procedures when connecting the pump to surface, open, and closed water sources. If surface water (lake, river, or stream) is used as the water source, general guidelines suggest the water pump should be located within 20 feet of the source and not more than 15 feet above it. However, a more likely scenario may have the water pump connected directly to a water bladder or tank placed near the heater unit.

2.3.1.1. Install the main water supply hose (25-foot suction hose) on the pump inlet connector.

2.3.1.2. If using surface or open water sources, install the strainer or intake screen on the opposite end of the suction hose. Then place the strainer end of the suction hose into the water source, ensuring the hose and strainer are positioned so that sediment, sand, and other unwanted particles do not enter the suction hose. Make sure the strainer is completely submerged when in operation. **Figure 2.14** and **Figure 2.15** provide two improvised methods of placing the suction hose in open water sources. Almost any floatable object can be used in lieu of the 55-gallon drum and logs depicted in the two examples. See AFPAM 10-219, Volume 7, *Expedient Methods*, for more examples.

2.3.1.3. If using a closed water supply (bladder, tanks, facility water source, etc.), connect the pump suction hose without the strainer directly to the water source.

Figure 2.14. Expedient Drum Float Water Intake.

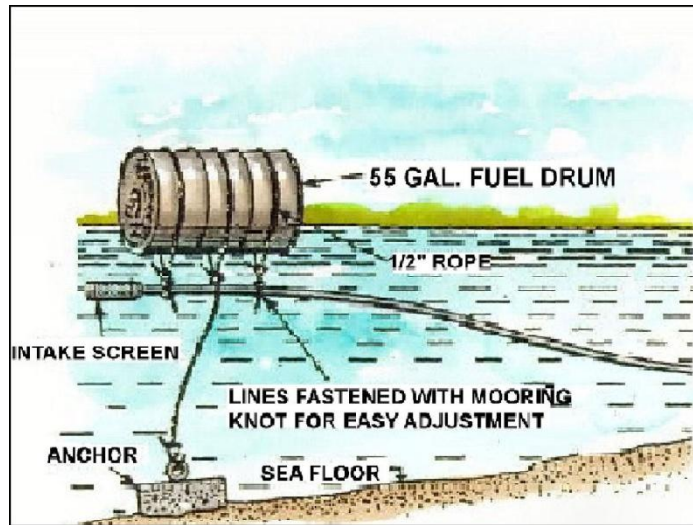
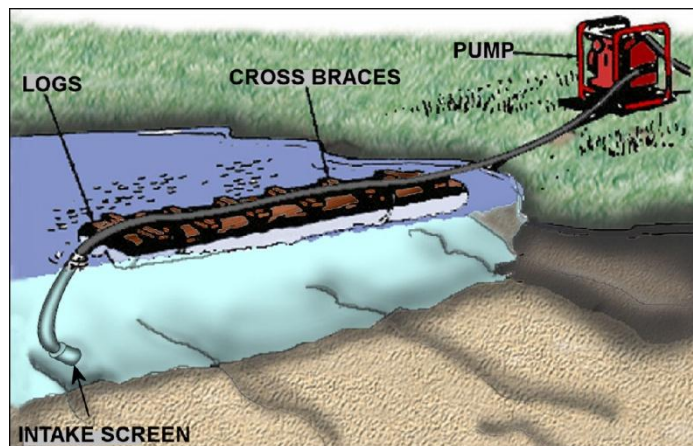


Figure 2.15. Expedient Log Float Water Intake.



2.3.2. **Assemble and Connect Water Heater.** Position the water heater on level ground and within five feet of the water pump. Prepare the heater unit for operation as follows:

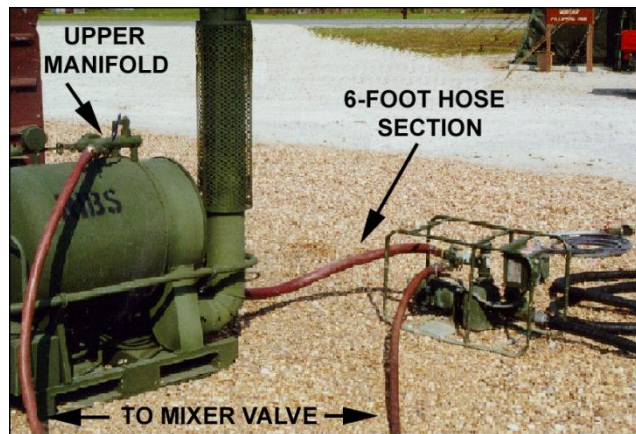
CAUTION

To prevent equipment damage, ensure hose couplings are free of dirt or foreign matter and the quick disconnect (QD) coupling gaskets are in place before connecting hoses.

2.3.2.1. Connect the water heater to the pump using the 6-foot hose section (**Figure 2.16**). The hose should extend from the pump to the heater intake manifold (lower manifold).

2.3.2.2. Connect the hot water supply hose (female end) to the hot water outlet fitting (upper manifold) on the heater (**Figure 2.16**). Then connect the other end of the hose to an appropriate mixing valve, if applicable. Although mixing valves have the same function, various types may be available in BEAR, so connection methods may differ.

Figure 2.16. M-80 Water Hose Connections.



2.3.2.3. Install the exhaust stack elbow on the water heater with a slight turn to the right to seat the pin in the slot. Attach the smoke stack and guard assembly on the heater (**Figure 2.17**). Make sure the bracket screw (**Figure 2.18**) is tightened to secure the smoke stack and guard assembly.

Figure 2.17. Elbow and Smoke Stack with Guard Assembly.

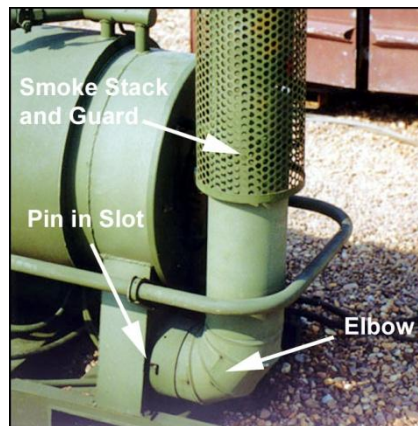


Figure 2.18. Smoke Stack Bracket Screw.



WARNING

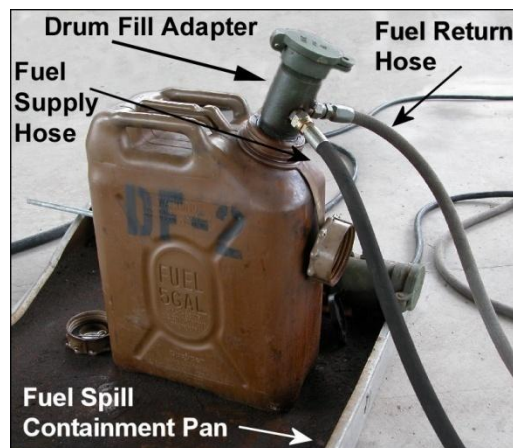
Fuel used with the water heater is highly flammable and may cause severe burns or death if handled improperly.

2.3.2.4. Place the fuel container about 5 feet from the heater. Screw the drum fill adapter into the top of the fuel container. Then devise a fuel spill containment system around the fuel storage container(s) and make sure a fire extinguisher is handy. Connect the fuel line from the fuel pump filter to the suction (supply) fitting on the drum fill adapter. Afterwards, connect the second fuel line from the fuel pump to the return fitting on the adapter (**Figure 2.19**).

CAUTION

Use only authorized fuels. Failure to do so may damage the equipment. See **Table 2.1** for authorized fuel types.

Figure 2.19. Fuel Line Connections to Drum Fill Adapter.

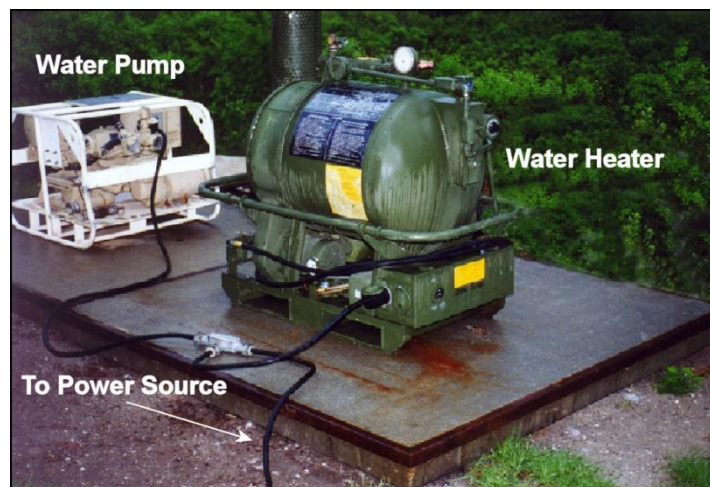


WARNING

Lethal voltage is present when the water heater is connected to a power source. Ensure power source is not energized when connecting power cables. Ensure that the power distribution cable is not frayed or damaged and does not lay in standing water. Serious injuries or death to personnel by electrocution could result.

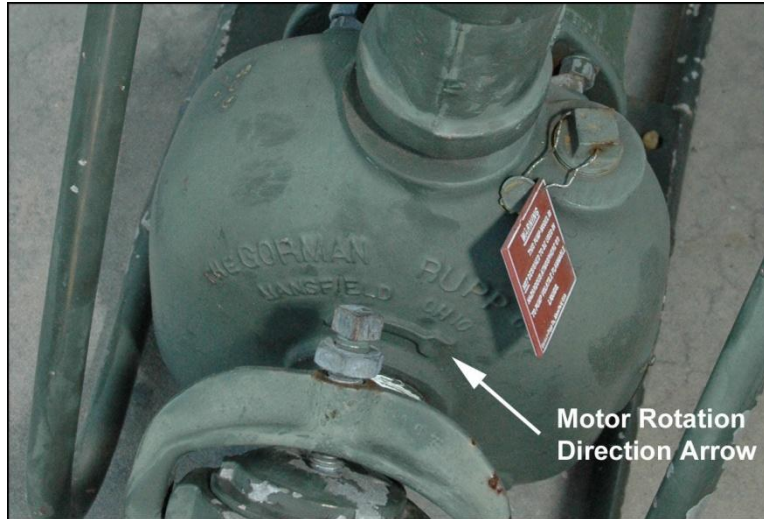
2.3.2.5. Connect electrical cable assemblies to the water pump, heater, and power source (**Figure 2.20**). Ensure the source is 208-volt, 3-phase, 60-cycle.

Figure 2.20. Electrical Connections.



2.3.2.6. Verify the electrical cable junction box is properly wired for the water pump by quickly turning the water pump switch on and off while noting the rotation direction of the motor. The motor must turn in the same direction as the arrow on the pump housing (**Figure 2.21**). If the rotation is incorrect, have an electrician reverse the leads in the junction box (a three-phase motor must have the phases properly connected to operate and run in the proper direction).

Figure 2.21. Pump Motor Rotation Direction.



2.3.3. Perform Preoperational Checks. Several checks should be accomplished before starting the water heater. Make final checks on the power cables and water pump, followed by preventive maintenance checks and services (PMCS) on the water heater.

2.3.3.1. Check the power cables to verify there are no cracks or other damage. Ensure power cables are properly connected to the water pump, water heater, and power source. Make sure the water pump intake hose strainer and water pump motor are clear of obstructions. If applicable, check the condition of mixing valves.

2.3.3.2. Perform ~~Before Operation~~ PMCS on the water heater according to **Table 2.2**. Ensure these checks are completed before making initial heater adjustments.

Table 2.2. M-80 “Before Operation” PMCS.

Check:	Unserviceable If:
Inspect the water heater for general signs of physical damage.	The water heater is damaged.
Check the fuel shutoff valve. Determine that it moves freely and does not bind or catch. Check for bent valve stem.	The fuel shutoff valve is binding or catching and does not open and close freely. Valve stem is bent.
Check condition of ignition cables. Determine if the cables are loose or frayed.	Cables are frayed or loose.
Check the vent valve and determine that it moves freely and does not bind or catch. Check for bent valve stem.	The vent valve is inoperative.
Check the combustion chamber sight glass. Determine if the glass is undamaged and assembly is securely installed.	The sight glass is missing or the assembly is not correctly installed, or is loose or damaged.
Check the serviceability of the smoke stack and guard assembly. Parts should fit tightly and have no dents. Check for excessive rust.	Parts are dented and do not fit together well or there is excessive rust on the parts, preventing a proper fit.

2.3.4. **Make Initial Heater Adjustments.** Make the following initial adjustments before starting water heater operation:

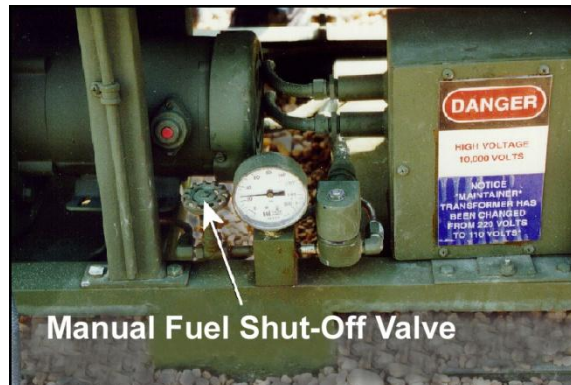
2.3.4.1. Make sure the water heater power switch (**Figure 2.22**) is turned OFF.

2.3.4.2. Ensure the manual fuel shutoff valve (**Figure 2.23**) is CLOSED.

Figure 2.22. Water Heater Power Switch.



Figure 2.23. Manual Fuel Shutoff Valve.



2.3.4.3. Press the reset button on the flame safeguard control (**Figure 2.24**) inside the control box assembly.

2.3.4.4. Open the blower air shutter approximately halfway (**Figure 2.25**).

Figure 2.24. Reset Button on Flame Safeguard Control.

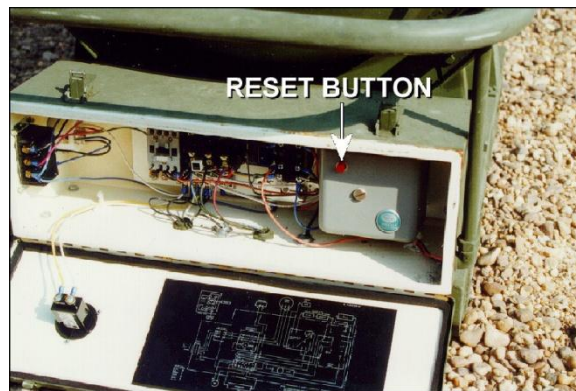
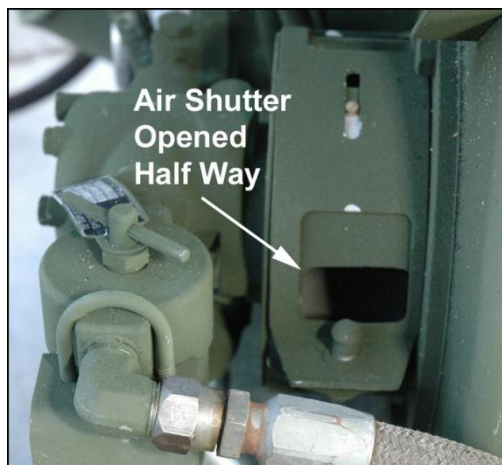


Figure 2.25. Blower Air Shutter.

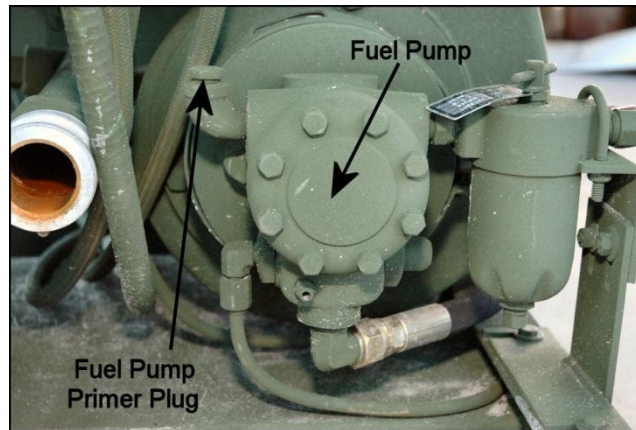


WARNING

Exposed fuel and fuel vapor can ignite or explode, resulting in possible serious injury or death. Observe proper safety precautions when servicing the fuel system.

2.3.4.5. Prime the fuel pump by opening the fuel pump primer plug and filling the fuel pump with fuel (**Figure 2.26**). Then replace the plug.

Figure 2.26. Fuel Pump Primer Plug.

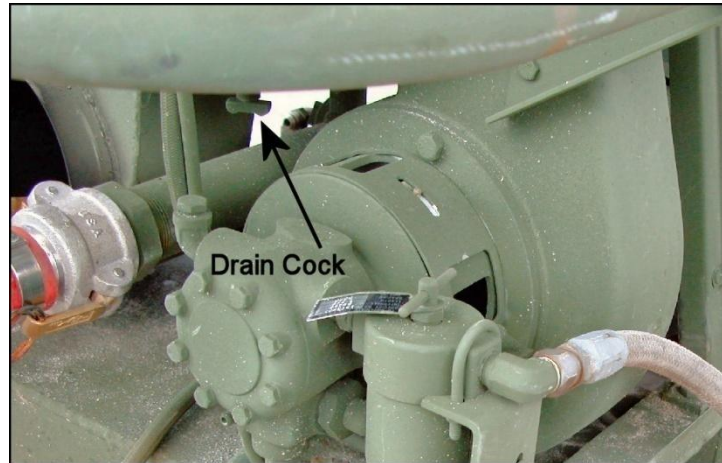


2.3.4.6. Ensure all water lines are connected and the water heater drain cock is closed (**Figure 2.27**).

2.3.4.7. Prime water pump according to directions or technical information for the specific pump being used.

2.3.4.8. Open the vent valve on the top of the water vessel and turn on the water pump. Allow vessel to fill with water until a steady stream of water comes out of the vent valve, then close the vent valve and turn off the pump. **Note.** Failure to bleed all air from the water heater will activate the low water switch, sounding the buzzer and preventing the unit from starting.

Figure 2.27. Water Heater Drain Cock.



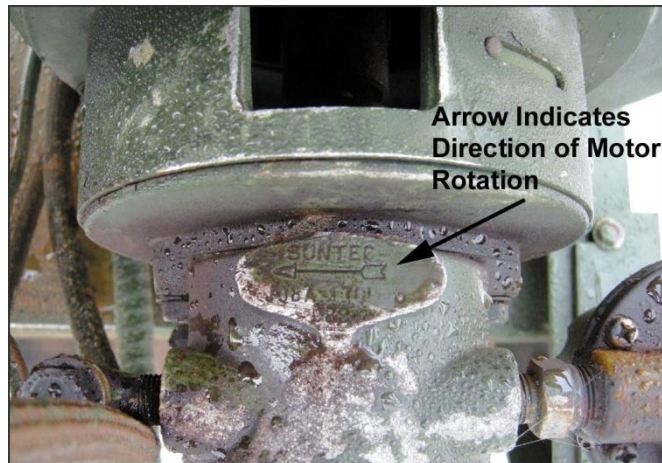
2.3.4.9. Set the operating control (temperature) knob to the desired setting. Temperature should be set between 160° F and 210° F.

2.3.4.10. Turn the heater power switch on and off quickly and note the rotation of the blower and fuel pump motor. If the motor is not rotating in the same direction as the arrow on top of the fuel pump (**Figure 2.28**), have an electrician reverse the leads on the control box power input plug (a three-phase motor must have the phases properly connected to operate and run in the proper direction).

WARNING

Lethal voltage is present when the water heater is connected to a power source. Disconnect from power source before inspecting or repairing any electrical component. Be careful not to touch electrical connections. Electrical shock and/or death may result from failure to heed this warning.

Figure 2.28. Fuel Pump Motor Rotation Direction.



2.4. Operation. Observe all safety precautions and follow the steps listed below to start up and operate the heater unit:

WARNING

Fuel is very flammable and can ignite easily. To avoid serious injury or death, keep fuel away from open flames. Do not work on fuel system when heater is hot. Shut off heater and do not smoke when working on fuel system.

- 2.4.1. Ensure the power source and water supply are turned ON.
- 2.4.2. Ensure the water pump and fuel pump are primed and the water vessel is full.
- 2.4.3. Open the fuel shutoff valve. The fuel pressure gauge should read 100 pounds per square inch (PSI). If operating at high altitudes, it may be necessary to adjust the fuel pressure. Refer to the water heater technical order for more information.

2.4.4. Turn the heater power switch ON. The combustion should occur within seven (7) seconds. The ignition spark can be viewed through the burner assembly sight glass, and the combustion can be viewed through the combustion chamber sight glass.

2.4.4.1. If combustion fails to occur, the water heater will automatically attempt another ignition. If combustion still does not occur, the buzzer alarm will sound and the ignition spark will shutdown.

2.4.4.2. When the buzzer sounds, press the reset button on the flame safeguard control. If combustion still does not occur within two minutes, refer to the technical order for troubleshooting actions.

2.4.5. After start up, and if necessary, slowly open the air shutter on the blower assembly until exhaust gases are transparent and smokeless. It may also be necessary to readjust the air shutter because normal vibration of the heater during operation could cause the air shutter to shift over time.

2.4.6. Ensure the water pump is on and the water pump valve is open. Also, verify the hot water output valve on the top of the water vessel is closed.

2.4.7. When the preset hot water temperature is reached, open the hot water output valve to deliver hot water (output valve is in-line with the pipe when open).

WARNING

Ensure water heater has cooled down before touching any part that may still be hot. Failure to comply may result in scalding or burning to skin.

2.4.8. Open the valve at a dispensing point (shower, sink, etc.) and adjust mixing valve temperature control to desired temperature.

2.4.9. During operation of the heater, several continual system checks should be made. See **Table 2.3** for a list of system checks.

Table 2.3. M-80 “During Operation” PMCS.

Check:	Unserviceable If:
Check fuel pressure gauge to verify it reads 100 PSI. Check for broken glass or stained dial.	The gauge is not in the proper range. Glass is broken and dial stained.
Check the fuel pump, fuel lines, fuel filter, and drum fill adapter for leaks, loose connections, and damage.	Fuel leaks, loose connections, or damage to fuel supply system is noted.
Check exhaust gases and, if necessary, adjust the air shutter until the exhaust emission is clear. Check the shutter for correct operation. The pin and shutter should operate smoothly and not bind or stick.	The pin or shutter does not move freely or they cannot be adjusted.

2.5. Shutdown Procedures. Perform the following shutdown procedures after normal use:

2.5.1. Close the fuel shutoff valve and turn OFF the heater power switch and water pump.

2.5.2. If the heater will be subjected to freezing temperatures (below 32° F) or will not be used for five or more days, also complete the following:

2.5.2.1. Remove the fuel supply hose from the fuel drum fill adapter, and place the end of the hose into a suitable container to drain fuel from the hose.

2.5.2.2. Turn ON the heater power switch, and operate the unit until the container is almost empty. Ensure the fuel shutoff valve is closed, and let the heater operate until the combustion flame goes out. Afterward, turn the water heater switch OFF.

2.6. Preparation for Storage or Shipment. Perform the following procedures before storing or moving the water heater:

2.6.1. Cease water-heating operations using shutdown procedures described in paragraph 2.5.

WARNING

Ensure power has been disconnected from the water heater control box assembly. Death or serious injury to personnel may result from electrocution. Ensure the water heater has cooled down before attempting to prepare it for movement. This will avoid possible injuries to personnel from burns and scalding.

2.6.2. Disconnect the power cable from the water heater and water pump.

2.6.3. Retrieve suction line from the water source and disconnect the strainer.

2.6.4. Disconnect water hoses from the lower and upper manifold assemblies and drain the hoses. The M-80 will drain when hoses are disconnected.

2.6.5. Verify the fuel shutoff valve is closed and disconnect fuel lines from the fuel drum fill adapter. Stow the fuel lines on the holder under the water vessel (**Figure 2.29**).

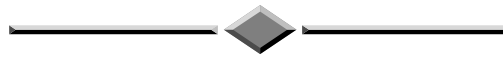
Figure 2.29. Fuel Line Stowage Position.



2.6.6. Disconnect and remove the smoke stack and drum fill adapter. Close the air shutter on the blower assembly.

2.6.7. Thoroughly clean and dry all items then pack them in their appropriate shipping boxes.

2.6.8. Perform ~~after use~~ PMCS according to applicable technical data when time and circumstances permit.



Chapter 3

ADVANCED DESIGN REFRIGERATOR, 300 CUBIC FOOT (ADR-300)

3.1. General Information. The ADR-300 (**Figure 3.1**) provides refrigerated storage for a wide range of items, including food, medical supplies, and cadavers. The system also provides thermal protection for stored items during transport, including air shipment. It provides 281 cubic feet of storage space and can maintain inside temperatures as low as 0° F at 110° F ambient temperature. The system does not require personnel in any specific Air Force Specialty (AFS) for normal operation; however, AFS 3E1X1, Heating, Ventilation, Air Conditioning and Refrigeration (HVAC/R) technicians may be required for setup and some maintenance activities.

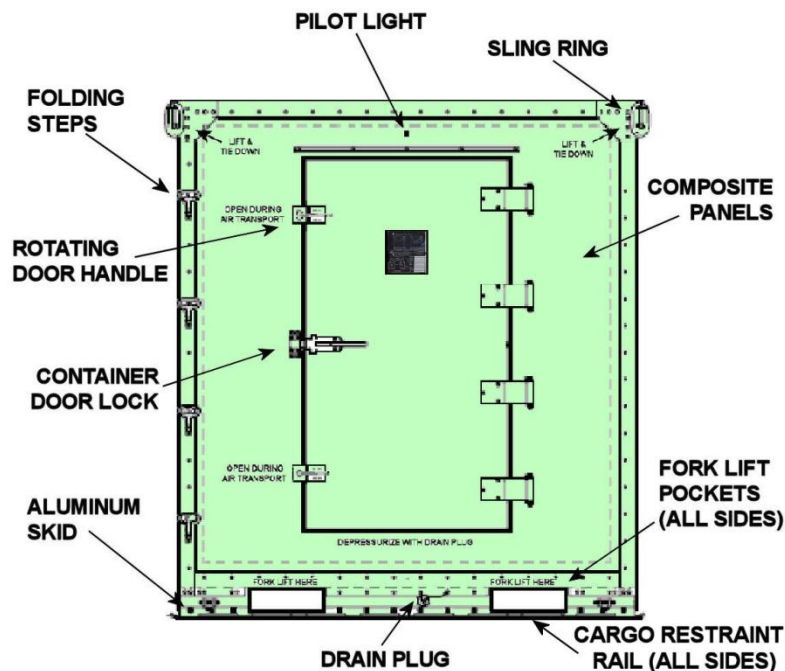
Figure 3.1. ADR-300.



3.2. Characteristics and Features. The ADR-300 is an insulated container constructed from aluminum-skinned composite panels and mounted on a formed aluminum skid. The refrigerator is available in green and desert sand colors. The skid includes forklift pockets and replaceable cargo rails on all sides. Some of the regular features are illustrated in **Figure 3.2**. The lever-activated container door lock is located on the left side of the door. The door

is further secured with two rotating door handle unit assemblies. Sling rings are attached to the four top corners of the container and used to lift the system either by crane or helicopter sling. Additional features are addressed in the following paragraphs.

Figure 3.2. ADR-300 Features (Front View).

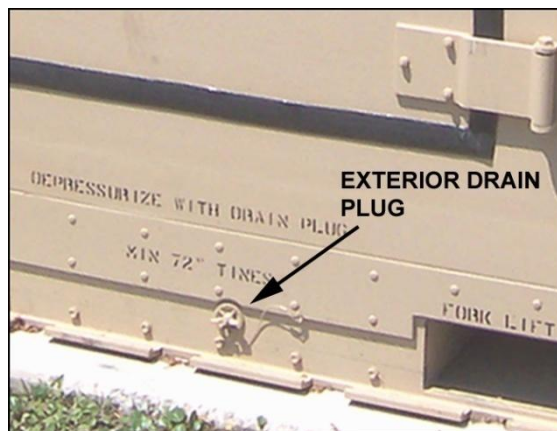


3.2.1. Floor Drain and Exterior Drain Plug. A floor drain (Figure 3.3) removes liquids trapped inside the container by discharging the fluids through a one-inch diameter tube to a port at the front of the skid. A plug at the exit end of the tube seals the drain (Figure 3.4). This plug also serves as a pressure release in the event of a sudden decrease of outside pressure.

Figure 3.3. Interior Floor Drain.



Figure 3.4. Exterior Drain Plug.



3.2.2. Interior Shelving and Tie-Down Rings. The container has two sets of removable shelving, and each set consists of five shelves. Every shelf has a storage surface measuring 72 3/4 x 21 inches and can hold up to 300 pounds (lbs). The shelves are easily adjusted and can be disassembled and removed

from the container to accommodate bulk materials or to ease cleaning of the interior. Bulk cargo not stored on shelves can be secured to the tie-down rings located on the container floor (**Figure 3.5**). Fourteen tie-down rings are located around the inside perimeter of the container. Each ring can withstand up to 7,500 lbs of tension.

Figure 3.5. Tie-Down Rings.



3.2.3. Interior Light. The inside of the refrigerator is lighted by a single light fixture located above the door (**Figure 3.6**). The light is controlled by a switch mounted next to the light fixture. The pilot light outside the door illuminates when the inside light is switched on, alerting users that the light is on without opening the door. Power is supplied to the switch and light through a surface-mounted conduit that runs along the upper left inside of the container.

3.2.4. Quick-Release Plunger. The quick-release plunger (**Figure 3.7**) is located on the interior side of the refrigerator door and is used in conjunction with the interior door handle unit assemblies to open the door from the inside.

Figure 3.6. Light Fixture and Switch.

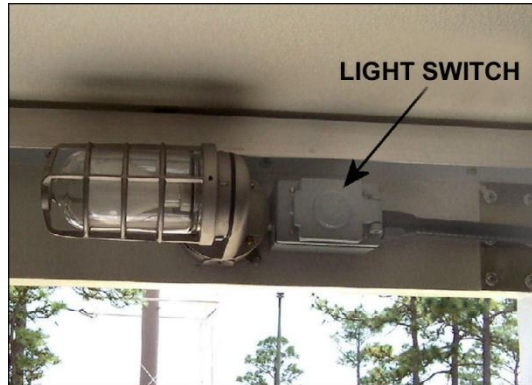


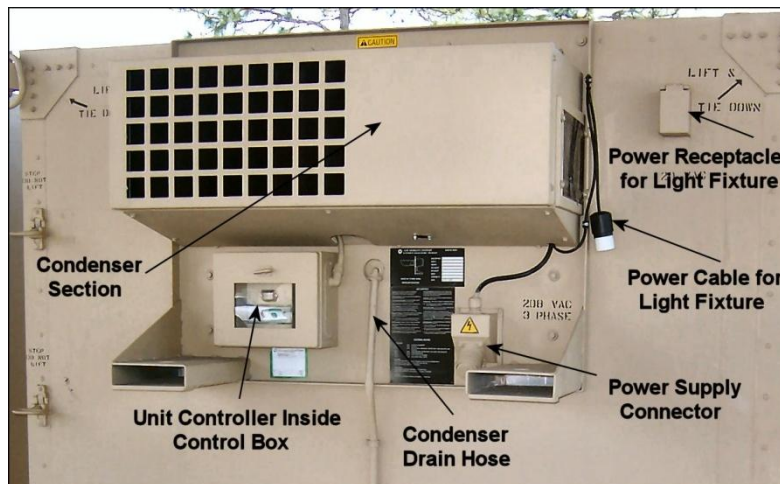
Figure 3.7. Plunger.



3.2.5. **Refrigeration Unit.** The refrigeration unit (**Figure 3.8**) maintains the temperature inside the container and includes the refrigerator assembly, power supply, and control components. The unit mounts in an opening on the back of the container and is very heavy. Handle this unit carefully, and always comply with technical order safety procedures.

3.2.5.1. **Power Supply.** A 208/230-volt, 3-phase, 50-60 hertz (Hz) power supply is needed to operate the refrigeration unit. Power is supplied to the refrigerator and various control components through a connector on the mounting plate just below the condenser section (**Figure 3.8**). A power cable also extends from the refrigeration unit to supply power to the inside light fixture.

Figure 3.8. Refrigeration Unit Features.



3.2.5.2. **Refrigerator Assembly.** The refrigerator assembly uses 4.62 pounds of R-404A refrigerant as a normal charge. Its cooling capacity is rated at 5000 BTUH at 0° F and 9000 BTUH at 35° F. The condenser section extends out the back of the container, and the evaporator section of the refrigerator protrudes into the container as shown in **Figure 3.9**.

3.2.5.3. **Control Components.** The unit controller is located in a weather-proof box on the left side of the mounting plate (**Figure 3.8**). It includes a keypad for entering control commands and a display that provides system operating information to the operator. The controller display and keys are used to change operating settings and monitor operating status. **Figure 3.10** and **Table 3.1** identify display and keypad functions on the controller display.

Figure 3.9. Evaporator Unit Protrudes Inside Container.

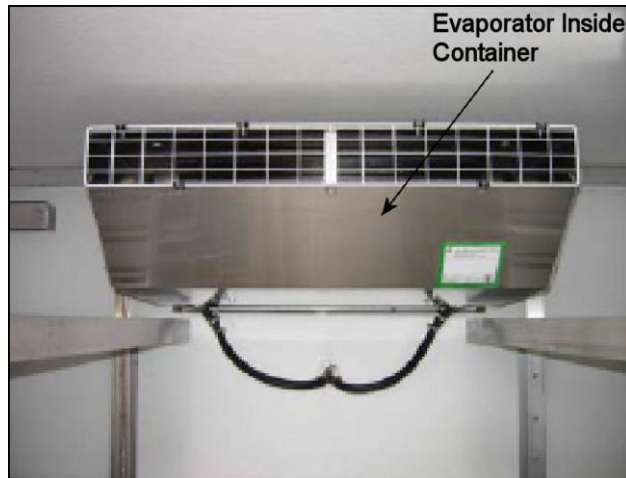


Figure 3.10. Controller Display and Keypad.

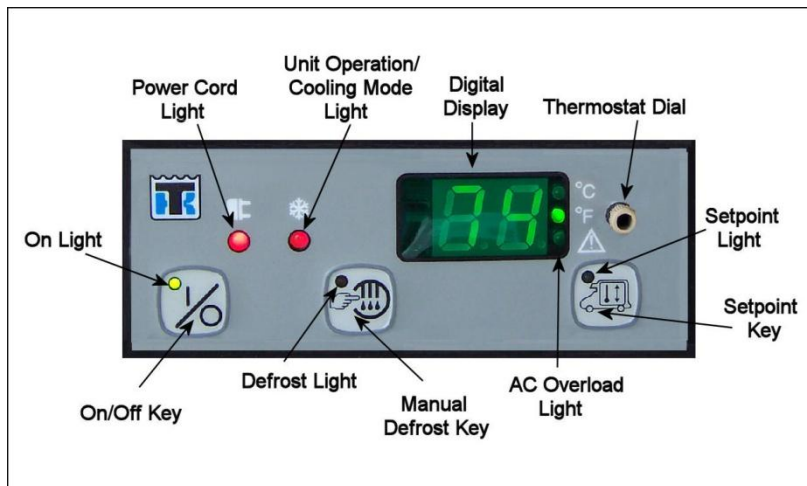


Table 3.1. Display and Keypad References.

Item	Function
On/Off Key	Press this key to turn the unit ON and OFF. When the unit has been stopped by the HEAT or COOL overload relay, press this key to restart the unit. Light illuminates when unit is turned ON.
Power Cord Light	Illuminates when the unit is connected to an AC power source.
Unit Operation/Cooling Mode Light	Illuminates when unit is operating in either the cooling or heating modes. A green light indicates the unit is in the cooling mode. A red light indicates the unit is in the heating mode. When the unit is stopped by the thermostat, high-pressure cut-out (HPCO), or low-pressure cut-out (LPCO), the unit operation indicator light will be OFF and the ON indicator will remain ON.
Defrost Light	Illuminates when the unit is in the defrost mode.
Manual Defrost Key	Press this key to start the defrost cycle. The unit will not defrost unless the push switch is closed and the evaporator coil temperature is below 36° F (2° Celsius (C)).
Thermostat Dial	Turn dial to adjust thermostat setpoint. Dial will change thermostat setpoint without pressing the setpoint key.
Setpoint Key and Light	Press this key to make the thermostat setpoint appear on the digital display. The thermostat setpoint appears for 10 to 15 seconds, giving the operator time to adjust the thermostat setpoint key. The light illuminates when setpoint temperature is displayed.
AC Overload Light	Illuminates when the overload relay has opened and the unit has been stopped. Reset the light by pressing the ON/OFF key after allowing the overload relay to cool. Manually reset overload relay IAW technical data.
Digital Display	Normally displays the thermometer reading (return air sensor temperature) when the unit is turned on. Thermostat setpoint is temporarily displayed when setpoint key is pressed.

3.3. Set-Up Procedures.

WARNING

The ADR-300 weighs as much as 10,000 lbs (4,536 kilograms (kg)) when fully loaded. Lift and move the container only with material handling equipment of at least 10,000-lb capacity. Observe all safety precautions and never stand under an ADR-300 when it is being lifted.

3.3.1. **Siting the ADR-300.** Site the container in an area that is relatively level and free of rocks and other obstructions. The cleared area should be large enough for the container itself and permit unrestricted movement of cargo handling equipment. The site should have adequate surface drainage and an appropriate electrical power supply. Unload and move the container using a forklift or overhead crane. When using a forklift, use any of the built-in forklift pockets on the container base (**Figure 3.11**), and use a spotter to ensure forklift blades enter the forklift pockets. If using an overhead crane and sling lines to hoist the container, ensure that the sling lines create an angle of MORE THAN 45° with the container roof to prevent structural damage to the ADR. Ignoring these procedures may result in damage to the equipment.

Figure 3.11. Built-In Forklift Pockets.



3.3.2. Unpacking and Assembling. The ADR-300 typically does not require unpacking or assembling prior to normal use. All components are pre-mounted in their operational positions. However, if the refrigeration unit is not mounted or requires replacement, remove and install the refrigeration unit according to procedures in T.O. 40R7-6-1, *Operator's, Unit, and Direct Support Maintenance Manual, Advanced Design Refrigerator, 300 Cubic Foot, (ADR-300)*. If removing or installing the refrigeration unit, be sure to use a lifting device (forklift, crane, etc.) with a load capacity greater than 1500 pounds (**Figure 3.12**). Prior to using the ADR-300, complete a general system inspection to be sure the refrigeration unit is serviceable. A general system inspection includes all of the "Before" system checks presented in paragraph 3.4.1.

Figure 3.12. Installation of Refrigeration Unit with a Forklift.



3.3.3. Connecting Power Supply. Perform the following procedures when connecting electrical power to the ADR-300:

3.3.3.1. Turn all switches to the OFF position.

WARNING

The ADR-300 electrical system uses high voltage power. Do not attempt to alter or repair electrical wiring. Make sure power supply circuit breakers are in the OFF position before connecting or disconnecting the power supply. Failure to comply may result in serious injury or death to personnel.

3.3.3.2. Plug the power supply cable into a 208/230 Volts Alternating Current (VAC), 3-phase, 50-60 Hz supply outlet. **Note.** Depending on the supply power frequency at the site (50 or 60 Hz), the refrigerator's compressor overload relay may need to be reset. The unit is set at the factory at 15 Amps for 60 Hz power. If 50 Hz power is used, set the overload relay to 12.5 Amps. Refer to T.O. 40R7-6-1 to check and adjust the overload relay setting.

3.3.3.3. Plug the other end of the power supply cable into the five-pin cannon plug (**Figure 3.13**) on the refrigeration unit.

Figure 3.13. Power Supply Cable Connection to Refrigeration Unit.



3.3.3.4. Plug the container power supply cord into the container power connector assembly (Figure 3.14).

Figure 3.14. Container Power Supply Cord Connection.



3.4. Operation. Before starting or operating the ADR-300, look for signs of trouble with the refrigerator unit. Often you can feel, smell, hear, or see many problems before they get worse. Perform the “Before Operation” PMCS to ensure the refrigerator and its associated equipment are in good working condition.

3.4.1. Perform “Before Operation” PMCS. PMCS verifies that all components are correctly installed and secure and there is no visible damage to the frame or components that could cause unsafe operation. Perform “Before Operation” PMCS according to procedures in **Table 3.2.**

Table 3.2. ADR-300 “Before Operation” PMCS.

Check:	Unserviceable If:
Surfaces: Inspect all interior and exterior surfaces of the container for cracks, breaks, or dents.	A hole passes through the inner and outer skins, holes in either skin exceed 1 inch in length or 1/2 inch in depth, or any crack exceeds 1-inch in length.
Sling Ring Brackets: Inspect the sling ring brackets for separation from the container.	Deformed, separated, or missing sling ring brackets are discovered.
Exterior Drain Plug and Hose: Inspect the exterior drain plug, and inspect the hose to confirm it is properly restrained.	The drain plug or hose is missing or hose is improperly restrained.
Cargo Restraint Rails: Inspect cargo restraint rails for deformation, cracks, breaks, or corrosion.	Missing, damaged, or corroded cargo restraint rail is identified.
<p>Container Door Panel: Open the door—note any resistance in the door locks or hinges.</p> <p>Close the door and lock the main and secondary handles—note any resistance to swinging or to movement of the door locks.</p> <p>Inspect the perimeter of the door to ensure the seal lays flat against the doorframe everywhere.</p>	Any moving part does not move smoothly or the door does not form a proper seal around its entire perimeter.

Check:	Unserviceable If:
<p>Container Shelf Assembly: When installed, verify all shelves are present, properly supported at the corners, and not damaged or deformed.</p> <p>Verify the shelves and rubber spacers rest against the container interior surfaces.</p> <p>Confirm the bottom shelves are secured to the floor.</p>	<p>Any shelf is damaged or not properly supported. Vertical supports are damaged. Screws or other attachment hardware is missing.</p>
<p>Light Fixture, Switch, and Light Indicator: Inspect the light switch inside the container for damage.</p> <p>Verify power is connected to the refrigeration unit and the container.</p> <p>Switch on the light to confirm the light illuminates and that the exterior light indicator is lit.</p> <p>Switch off the light.</p>	<p>The light switch, light fixture, or light indicator is damaged or non-operational.</p>
<p>Refrigeration Unit Interior: Inspect the inside (evaporator) section. Note any damage to the housing.</p> <p>Inspect for refrigerant oil residue.</p>	<p>There is visible damage to the housing or evidence of refrigerant oil on exterior surface.</p>

Check:	Unserviceable If:
<p>Refrigeration Unit Exterior: Inspect the eight mounting bolts holding the unit on the container for security of attachment.</p> <p>Inspect the sling rings for breaks, cracks, or deformation.</p> <p>Inspect all wires for condition and proper attachment at both ends.</p> <p>Verify the refrigeration unit is plugged into a 208/230 VAC, 50-60 Hz, 3-phase electrical source.</p> <p>Inspect the condenser section enclosure for damage and security of attachment.</p> <p>Inspect refrigerant lines for damage or evidence of refrigerant oil residue.</p> <p>Verify the control box is securely attached to the base plate and free of cracks or other damage. Confirm the wire connecting the control panel to condenser section is in good condition and securely connected at both ends.</p> <p>Inspect the condensation drain to ensure it is not blocked and there is no visible damage.</p>	<p>There is missing attachment hardware; loose or unsecured refrigeration unit; damaged or missing sling rings; damaged, frayed, or loose wires; damaged or loose condenser housing; damaged or leaking refrigerant lines; damaged or loose control panel; damaged breaker box.</p> <p>There is evidence of refrigerant oil on exterior surface.</p>

Check:	Unserviceable If:
<p>Refrigerator Operation: (After starting the refrigerator unit according to paragraph 3.4.2.) Note the interior temperature.</p> <p>Set the setpoint to 32° F (if the interior temperature is lower than 32° F, set the setpoint at least 5° below the interior temperature). Confirm that the unit operation indicator light glows green (cooling mode).</p> <p>After the interior temperature has dropped below 36° F, start a manual defrost cycle. Confirm that the defrost indicator light is on.</p> <p>Set the thermostat setpoint to approximately 50° F. Confirm that the unit operation indicator light glows red (heating mode).</p>	<p>The refrigerator does not enter the heating mode when the setpoint is above the interior temperature or cooling mode when setpoint is below the interior temperature.</p> <p>The defrost mode does not start when the manual defrost is initiated.</p>

3.4.2. **Start the Refrigeration Unit.** After connecting the power supply and performing PMCS, start the refrigeration unit as follows:

3.4.2.1. Press the ON/OFF key on the unit controller. The ON/OFF light will remain illuminated and the unit will start, stop, and defrost automatically while maintaining the desired setpoint temperature.

3.4.2.2. Enter the setpoint by pressing and holding the setpoint key. The setpoint temperature will be displayed in the display window for 10-15 seconds. Adjust the setpoint up or down by rotating the thermostat dial while the setpoint is displayed.

3.4.2.3. Release the setpoint key. The display will return to the inside temperature after approximately 10-15 seconds. **Note.** Do not move the thermostat dial after adjusting the setpoint. The setpoint may be changed without the setpoint temperature being displayed.

3.4.2.4. Verify that the new setpoint was entered by pressing the setpoint key and checking the display.

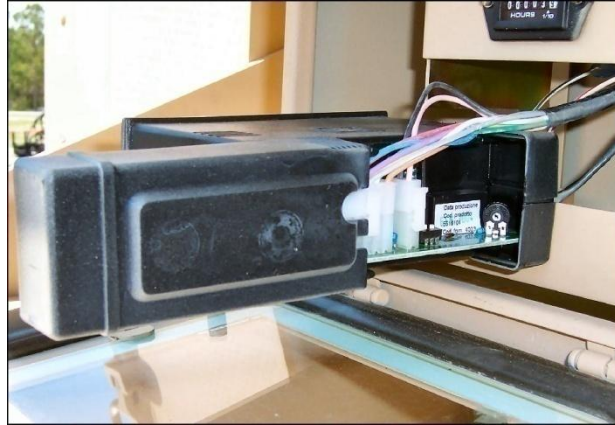
3.4.3. **Select Temperature Scale.** The temperature readings can be displayed in either the Celsius scale or the Fahrenheit scale. To change the temperature scale on the controller display, proceed as follows:

3.4.3.1. Open the control box; pull out the controller, and slide open the cover on the back of the controller as shown in **Figure 3.15** and **Figure 3.16**.

Figure 3.15. Controller Removal.

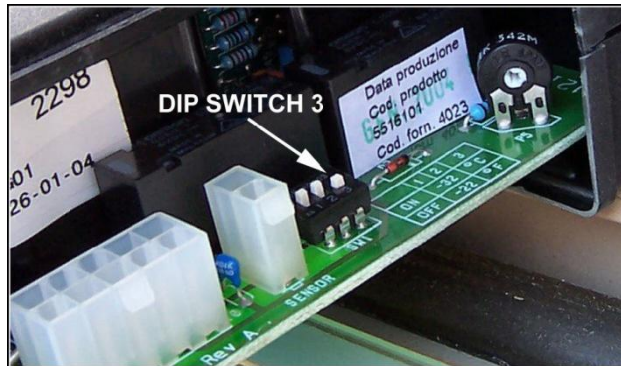


Figure 3.16. Opened Back Cover on Controller.



3.4.3.2. Place dip switch 3 (**Figure 3.17**) in the desired position: Up (ON) for Celsius, and Down (OFF) for Fahrenheit. Afterwards, replace the cover, reposition the controller, and close the control box.

Figure 3.17. Dip Switch 3 in Down/OFF (Fahrenheit) Position.



3.4.4. **Perform Operational Checks.** Once the refrigeration unit is operating, make periodic checks according to **Table 3.3** and lubricate refrigeration container parts according to **Table 3.4**.

Table 3.3. ADR-300 Operational PMCS.

Check:	Unserviceable If:
Refrigeration Operation: Check that the interior temperature is holding at the setpoint. Check that the air pathways are not blocked. Check accumulation of frost on inside unit.	Temperature is not maintained, pathways are blocked, or there is significant frost accumulation.
Refrigeration Container: Check the entire container for damage. Check the door fit and seal. Check door hinges and handles for lubrication. Check for loose or missing hardware.	There are damaged container panels or loose, missing, or damaged components or there is binding or restricted movement of moving parts.

Table 3.4. ADR-300 Lubrication Requirements.

Components	Lubricant	Frequency
Door Hinges	Light Oil Lubricant	Weekly (or as required)
Door Locks	Light Oil Lubricant	Weekly (or as required)
Roof Access Steps	Light Oil Lubricant	Weekly (or as required)

3.4.5. **Unusual Operating Conditions.** Several environmental conditions can present special challenges to ADR-300 operation. They may include high humidity, low and high ambient temperatures, blowing sand or dust, snow, or other conditions.

3.4.5.1. **High Humidity Conditions.** High humidity may increase the rate at which frost accumulates on the evaporator coil. Avoid opening and closing the cargo door more than necessary. This will reduce the amount of humid air

entering the container and the resulting accumulation of frost. Although the refrigeration unit is designed to defrost automatically, users should monitor the level of frost accumulation on the evaporator (interior) coil. If a significant level of frost is observed, begin a manual defrost cycle or adjust the defrost timer according to T.O. 40R7-6-1.

3.4.5.2. **Low and High Ambient Temperatures.**

3.4.5.2.1. Low ambient temperatures enhance the performance of the refrigeration unit; however, those conditions also cause plastic and rubber elements to stiffen and become brittle. Handle plastic and rubber parts gently in cold weather to avoid cracking or breaking. The door gasket may freeze to the doorframe; therefore, pull firmly and steadily to separate the gasket from the frame when opening the container door.

3.4.5.2.2. High ambient temperatures result in high refrigeration loads while degrading the performance of the refrigeration unit. Therefore, the user should try to minimize the loads on the system in this environment. Locate the ADR such that it is shaded from the midday sun. Avoid opening the container door and do not hold the door open longer than necessary. Avoid, to the greatest extent possible, placing large, warm cargoes in the container all at once.

3.4.5.3. **Blowing Sand and Dust.** Sand and dust tend to damage moving parts and accumulate on the refrigeration coils, particularly the condenser (outside) coil. Clean the coil surfaces regularly with water and remove accumulations of sand and dust by blowing compressed air over them. Also, avoid opening and closing the container door more than necessary. During short periods of high levels of airborne sand or dust, the ADR may be shutdown and the refrigeration unit covered to reduce the amount of sand and dust drawn into the unit. If this is done, shutdown the ADR before covering the refrigeration unit and carefully monitor the container interior temperature to be sure it remains at safe levels for the stored cargo.

3.4.5.4. **Snow.** Accumulations of snow or ice around the condenser air inlet or outlet may reduce the airflow through the coil and degrade the performance of the refrigeration unit. Keep these openings as clear as possible to promote good airflow. **Note.** Do not permit more than 12 inches of snow to accumulate on the container roof. Accumulations of snow elsewhere on or

around the unit should not affect the ADR-300 performance. Users are advised to keep controls, displays, and gauges clear of snow accumulation to make routine ADR-300 operation and monitoring easier.

3.4.6. Emergency Procedures. There are two occasions when the ADR-300 may pose a danger to personnel and require emergency procedures; personnel locked inside the container and rapid loss of refrigerant.

3.4.6.1. Personnel Locked Inside the Container. Individuals locked inside the container with the refrigeration unit running or not, face a potential emergency. Personnel trapped inside the container may suffocate due to lack of fresh air or may suffer hypothermia (low body temperature) if exposed to low interior temperatures. To prevent these dangers, the container door can be opened from the inside at any time, even if the handle is padlocked. To open the door from the inside, simply rotate the interior door handle unit assemblies to the vertical position and push the plunger. This will release the door latch and allow the door to swing open.

3.4.6.2. Rapid Loss of Refrigerant. A rapid and total loss of refrigerant may result from a broken refrigerant line and may displace air, causing possible suffocation. In the event of a sudden loss of refrigerant, personnel should exit the container immediately and leave the door open to allow the refrigerant to dissipate.

3.4.6.3. Other emergencies may occur that do not present a hazard to personnel. These situations involve the potential loss or spoilage of cargo due to an inability of the system to maintain the required interior temperature. If the system is unable to maintain the preset interior temperature, refer to operator troubleshooting procedures in T.O. 40R7-6-1.

3.5. Shutdown Procedures. To shutdown, turn OFF the refrigeration unit at the control panel located inside the control box and unplug the power supply cable from the refrigeration unit.

3.6. Preparation for Storage or Shipment. When ADR-300 operations are completed, empty and clean the container, and prepare it for storage or shipment. If cargo will be stored inside the container during shipment, comply

with paragraph 3.6.3.1 and ensure that the cargo is stored according to loading procedures in T.O. 40R7-6-1 and other applicable guidance.

3.6.1. Cleaning. Wash both the interior and exterior of the container and allow the interior to dry thoroughly before closing it for storage. The exterior of the container and refrigeration unit may be washed with a low-pressure water spray. Ensure the ADR is disconnected from its primary power supply before washing the exterior, and be careful to avoid spraying water up into the condenser section of the refrigeration unit. The interior of the container should be cleaned only when the refrigerator is turned off and the interior is approximately room temperature (68 to 77° F). Use a low-pressure water spray and mild detergent to clean the container surfaces and shelves, and be careful to avoid spraying water up into the evaporator coil. Do not soak electrical components, and drain all water from the container through the floor drain.

3.6.2. Storing. If the ADR-300 will be unused for an extended period, take steps to preserve and protect the system. Basic steps include cleaning the unit and elevating it off the ground or floor to allow air circulation under the container. Place the container on at least three evenly-spaced 4- x 4-inch beams laid across the width of the container. This helps to prevent moisture accumulation and corrosion. If possible, store the container on a slight slope to enhance drainage. When storing ADR-300s, the containers may be stacked no more than two high. Lifting with a crane requires a hoist of 10,000-lb (4,536 kg) capacity and slings connected to the lifting rings in the upper corners of the container. Ensure that the sling lines create an angle of more than 45 degrees with the container roof to prevent structural damage to the ADR. Failure to comply may result in damage to the equipment.

WARNING

When stacking one ADR-300 on top of another, ensure both units are aligned so that front and side walls of top unit are flush with front and side walls of lower unit. This will ensure that the lower unit will support the weight of the top unit. Failure to comply may result in serious injury or death to personnel.

3.6.3. **Shipping.** The ADR-300 may be shipped in either an operational (refrigerated) or non-operational condition. The container is designed to retain cold temperatures inside for several hours without a source of power. The ADR may be transported by truck, rail, internal airlift, and external airlift (helicopter sling) according to procedures in T.O. 40R7-6-1. Regardless of which transportation method is used, be sure not to exceed the lifting, hoisting, or transporting weight limits of equipment and vehicles.

3.6.3.1. **Shipping in Operational Condition.** If the container will be shipped with refrigerated cargo, ensure the designated gross weight limit is not exceeded and complete the following steps.

CAUTION

Do not exceed the designated weight limit. The container's gross weight should never exceed 10,000 lbs (4,536 kg). Failure to comply may cause damage to the container or cargo handling equipment.

3.6.3.1.1. Restrain all cargo items as described in T.O. 40R7-6-1 and turn off the interior light.

3.6.3.1.2. If the cargo will not be damaged by freezing and time permits, reduce the setpoint temperature to a low level and allow the cargo to cool to that temperature.

WARNING

For ADR-300 systems that will be airlifted, door handle unit assemblies should be left unlocked, using only the main door handle to hold the door closed. This will allow pressure relief, if necessary, during flight. Failure to comply may cause serious injury or death to personnel. Failure to comply may also cause equipment to implode or explode, causing hazard to the aircraft.

3.6.3.1.3. Lock the cargo door and confirm the seal is satisfactory.

3.6.3.1.4. Confirm that the drain plug located under the door on the front face of the ADR-300 is installed.

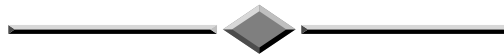
3.6.3.1.5. As near as possible to the departure time, shutdown the refrigeration unit, disconnect the power cord from the source of power, and move the container where necessary.

3.6.3.2. **Shipping in Non-Operational Condition.** If the ADR-300 is to be moved in a non-operational condition, complete the following steps:

3.6.3.2.1. Turn off the interior light, shutdown the refrigeration unit, and disconnect the power supply cord.

3.6.3.2.2. Clean the container interior according to paragraph 3.6.1.

3.6.3.2.3. Restrain all loose items inside the container to the restraint rings on the floor of the container, close and lock the cargo door, and move the container where necessary.



Chapter 4

FIELD DEPLOYABLE ENVIRONMENTAL CONTROL UNIT (FDECU)

4.1. General Information. The FDECU is the primary air conditioning and heating unit supporting BEAR sets (**Figure 4.1**). The unit provides cooled and dehumidified air, or heated air, through flexible ducts into various types of portable shelters and containers. The FDECU is available in several different models; however, the images and information presented in this chapter is generic in nature and not for any particular model, unless specified.

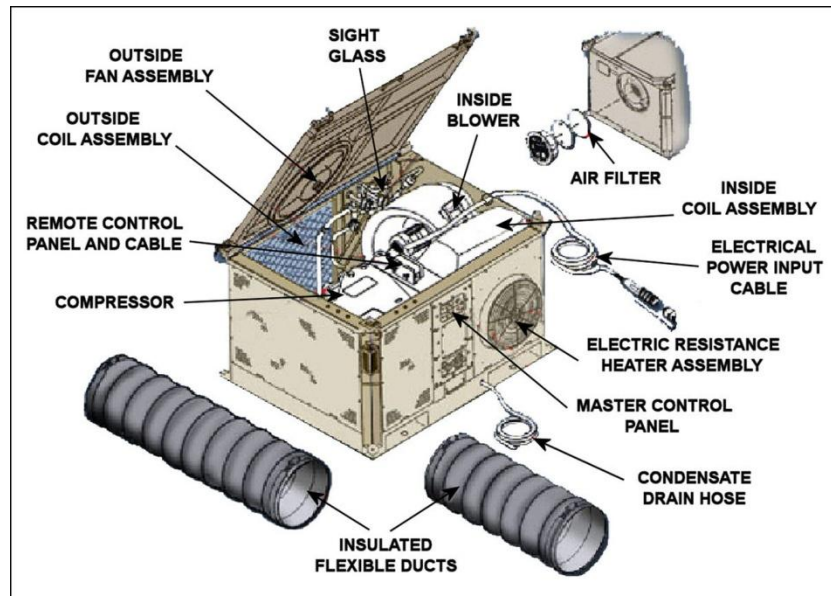
Figure 4.1. Field Deployable Environmental Control Unit (FDECU).



4.2. Characteristics and Features. The FDECU is a horizontally configured, electric-motor-driven heat pump. The unit will circulate and filter air and provide fresh make-up air as desired. It can be used while directly exposed to the environment and will operate with filter blower overpressure systems developed for use in Chemical, Biological, Radiological, and Nuclear (CBRN) environments. Total airflow is 2200 standard cubic feet per minute

(SCFM), and make-up airflow is adjustable between 0 and 500 SCFM. The unit uses 14 pounds of R-134A refrigerant as a normal charge and delivers cooling capacity at 55,000 BTUH to 67,000 BTUH and heating capacity at 47,000 BTUH to 84,000 BTUH. The FDECU weighs a maximum of 700 to 800 pounds (depending on model type), and a forklift will be needed to position the unit. Major features include the systems, subassemblies, and supporting equipment items identified in **Figure 4.2**. Descriptions of several key features are listed in subsequent paragraphs.

Figure 4.2. FDECU Major Components.



4.2.1. **Master Control Panel.** The master control panel (**Figure 4.3**) is incorporated into the FDECU and provide all the operator controls needed to start, operate, and stop the system, as well as maintain the desired shelter air temperature.

Figure 4.3. Master Control Panel.



4.2.2. Remote Control Panel and Cable. The remote control panel has a 35-foot cable that is normally mounted inside the shelter (**Figure 4.4**). It provides duplicate controls and indicators, similar to the master control panel.

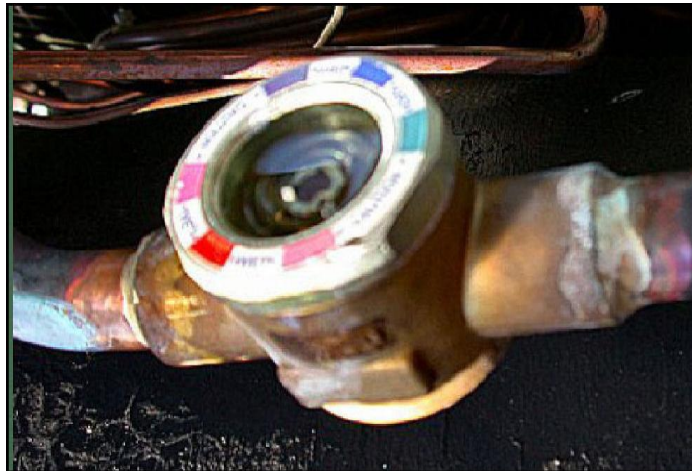
Figure 4.4. Remote Control Panel and Cable Routed Inside Shelter.



4.2.3. **Electrical Power Input Cable.** A 25-foot electrical power input cable is used to connect the FDECU to a source of electrical power for operation. The cable should be connected to a 3-phase, 208 VAC, 60 Amp power supply with ground. The power cable is stored on the inside of the FDECU when not in use.

4.2.4. **Sight Glass.** The sight glass, or liquid refrigerant indicator shown in **Figure 4.5**, permits visual inspection of the liquid refrigerant passing through the system and is used to aid in diagnosing possible refrigerant system problems. The sight glass also contains an indicator that changes color depending upon the amount of moisture contained in the refrigerant.

Figure 4.5. Sight Glass (or Liquid Refrigerant Indicator).



4.2.5. **Air Filter.** The replaceable air filter is located in the return air flange assembly (**Figure 4.6**). The filter removes dust and debris from the shelter air as it passes through the FDECU.

Figure 4.6. Replaceable Air Filter Located Inside Return Air Flange.



4.2.6. Electrical Resistance Heaters Assembly. This assembly contains two banks of electrical resistance heaters that are used (independently or together) to supplement the refrigerant system heating capacity in cold weather (Figure 4.7).

Figure 4.7. Supplemental Electric Resistance Heaters.



4.3. Set-Up Procedures.

WARNING

The FDECU is heavy (700-800 lbs) and requires an appropriate lifting device to move. Personal injury can result if moved without the aid of a lifting device.

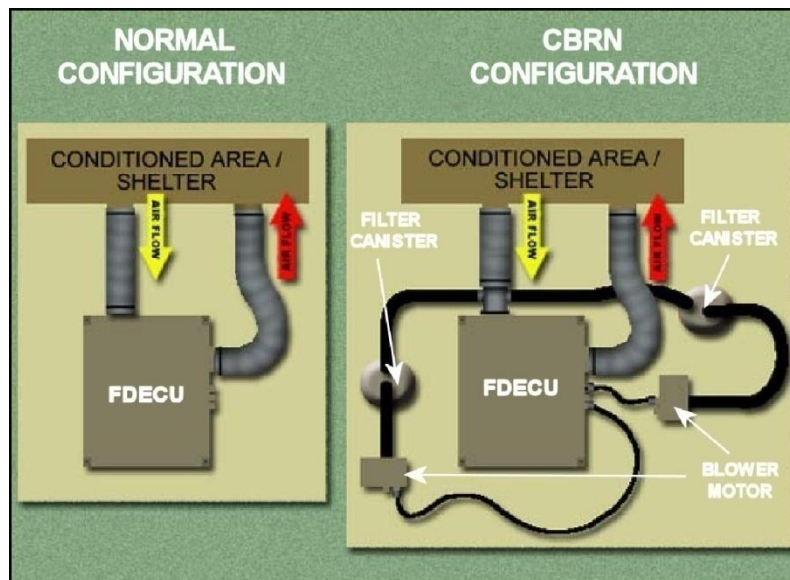
4.3.1. **Siting.** Place the FDECU in an operating position near the shelter or desired structure. The unit must be placed on a relatively level surface (not exceeding 5 degrees in any direction) and be positioned so that sides and top are at least 4 feet from any obstruction (**Figure 4.8**). Placement must also allow water to drain from the bottom in the winter during outside coil defrost cycles. When positioning the unit next to the shelter, be sure that the ducts can be connected with smooth bends and will not be kinked.

Figure 4.8. Siting FDECU.



4.3.2. **Configuration.** The FDECU can be configured for use in either normal environmental conditions or CBRN environmental conditions (**Figure 4.9**). Use in CBRN environmental conditions requires using a CBRN adapter kit and CBRN filter blower assemblies. Refer to T.O. 35E9-314-1, *Operator, Unit, Direct Support and General Support Maintenance Manual, Field Deployable Environmental Control Unit (FDECU)*, for specific CBRN hardening procedures.

Figure 4.9. FDECU Sample Configuration.

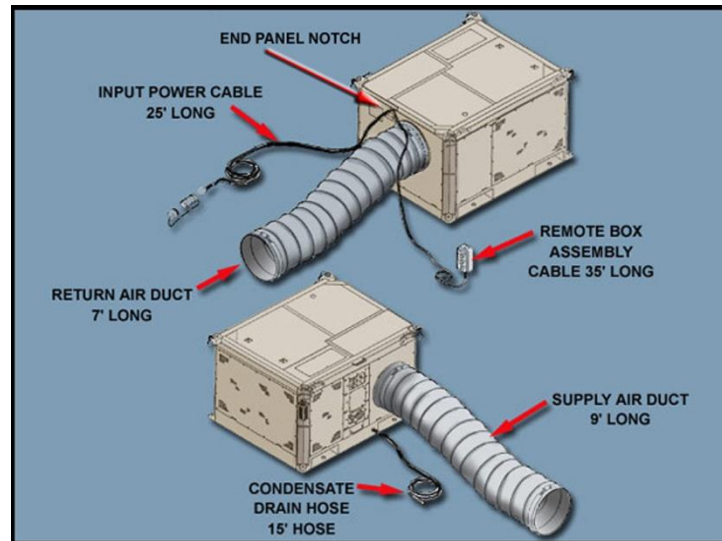


WARNING

The FDECU cover is heavy. Be sure the cover retaining rod is in place and properly secured with the hair pin cotter. Injury can occur if cover drops.

4.3.3. **Unpacking and Assembling.** When unpacking the FDECU, examine the equipment for damage and the presence of all required components (**Figure 4.10**).

Figure 4.10. Unpacked FDECU Components.



4.3.3.1. Begin unpacking by raising and securing the cover. Make sure the hair cotter pin securing the cover is installed into the rod from the top according to **Figure 4.11**.

4.3.3.2. **Unpack Input Power Cable.** Carefully uncoil the input power cable assembly and extend the cable outside the unit. Make sure the cable rests in the end panel notch.

4.3.3.3. **Unpack Air Ducts.** Remove the two insulated flexible air ducts. The return air duct is 7 feet long and the supply air duct is 9 feet long.

4.3.3.4. **Remove Shipping Cover From Return Air Volute Assembly.** Unclip the quick-release pin and remove the flange assembly (**Figure 4.12**). Turn the flange counterclockwise to remove. Take out and store the shipping

cover, and reassemble the flange assembly (**Figure 4.13**). Install the flange assembly into the volute assembly with the perforated duct collar facing out. Align the slots and turn clockwise to lock in place.

Figure 4.11. Hair Cotter Pin Installation.



Figure 4.12. Return Air Flange Assembly Removal.



Figure 4.13. Removal of Shipping Cover from Return Air Volute.



4.3.3.5. Remove Shipping Cover From Supply Air Volute Assembly. Loosen the six screws securing the supply panel (**Figure 4.14**), and remove the supply panel from the lower retaining clips. Slide the shipping cover out of the supply panel and store for reuse.

4.3.3.6. Unpack Condensate Drain Hose. Uncoil the condensate drain hose, and pass it through the hole in the frame. Pull the entire length of hose from the unit while leaving it attached to the volute assembly.

4.3.3.7. Adjust Heater Barrel and Reinstall Supply Panel. Unclip the four quick release pins on the heater barrel (**Figure 4.15**). Carefully pull the heater barrel out to stops (approximately 4 inches). Install the supply panel into the lower retaining clips, and then slip the panel over the heater barrel while aligning the mounting holes. Secure the supply panel by reinstalling the six screws.

Figure 4.14. Loosen Supply Panel Screws.



Figure 4.15. Removal of Quick Release Pins on Heater Barrel.



4.3.3.8. Mount Remote Control Box in Shelter. Release the two wing nut fasteners and any fastener straps securing the cable. Lay the cable and remote control box outside the FDECU. Ensure the cable rests in the end panel notch. Route the remote control box inside the shelter then mount the box at eye level away from drafts or supply air opening. Seal any opening made in the shelter. If a mounting bracket is not available in the shelter, the bracket used to store the remote control box in the FDECU can be removed and mounted inside the shelter using standard hardware or clamps. If the bracket from the FDECU is removed, make sure to reinstall the bracket attachment hardware (screws, nuts, washers, etc.) back into the holes on the FDECU.

CAUTION

Ice could form on the inside coil if airflow is restricted. Ducts must be installed as straight as possible with a minimum number of bends. Unit performance will be affected and damage to equipment could occur if airflow is restricted.

4.3.3.9. Connect Air Ducts. Install the 9-foot-long supply air duct between the heater barrel and the shelter supply duct connector. Be sure the duct is installed with the airflow direction arrow pointed toward the shelter. Afterward, secure the duct by tightening the two clamps. Install the 7-foot-long return air duct between the flange assembly and shelter return duct connector. The airflow direction arrow should be pointed toward the FDECU. The perforated holes in the flange assembly (**Figure 4.16**) are intended to provide from zero to 500 SCFM of fresh outside air to the shelter depending on how many, if any, holes are exposed. At least four or five rows of perforated holes should be exposed to assure a continuous supply of fresh make-up air. Position the air duct on the flange assembly as necessary and secure into place by tightening the clamps.

4.3.3.10. Connect Input Power Cable Assembly. Connect the input power cable to a 208 VAC, 3-phase, 50/60 Hertz, 60 Amp power supply with ground (**Figure 4.17**).

Figure 4.16. Perforated Holes and Clamps on Return Air Flange.

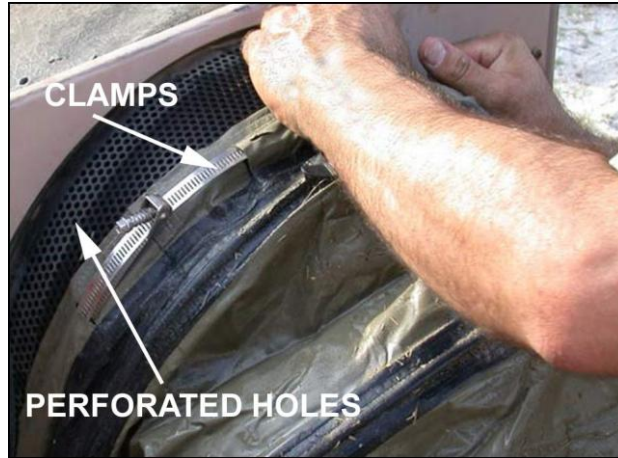
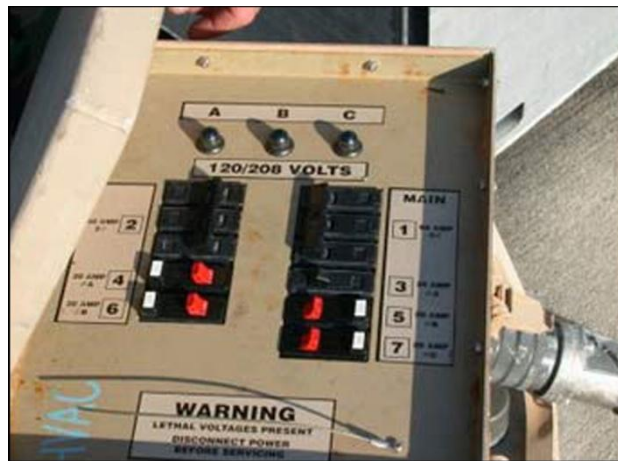


Figure 4.17. FDECU Connected to 208 Volts AC Power Supply.



4.4. Operation. Operation of the FDECU is not complicated; however, before commencing operations, operators must perform ~~Before Operation~~ PMCS to determine if the unit will function properly.

4.4.1. **Perform “Before Operation” PMCS.** PMCS is essential to the efficient operation of the FDECU and is necessary to prevent possible damage that may occur through neglect or failure to observe warning signs and symptoms in a timely manner. Perform ~~Before Operation~~ PMCS according to procedures in **Table 4.1**. If the FDECU has been in storage prior to use, also perform the ~~Weekly~~ and ~~Monthly~~ PMCS according to **Table 4.2** and **Table 4.3** prior to operating the unit.

Table 4.1. FDECU “Before Operation” PMCS.

Check:	Unserviceable If:
Flexible Air Ducts: Inspect for worn or torn spots and secure attachment to unit and shelter. (Reattach as necessary.)	Air ducts cannot be securely attached to unit or shelter. Torn to the point that it will not carry air to shelter.
Outside Coil: Inspect for dirt or obstruction to coil. (Remove obstruction or clean as necessary.)	Dirt or obstruction cannot be removed.
Outside Fan: Check to ensure fan is securely attached to motor and ensure nothing obstructs normal fan blade rotation.	Fan is loose on motor shaft.
Liquid Refrigerant Indicator (Sight Glass): Inspect liquid indicator for cracks and note center indicator color.	Liquid refrigerant indicator port is cracked or center indicator color is yellow or red, depending on type of liquid indicator being used.
Control Panel: Check for damage to knob, switch, or push button.	Control panel damage would prevent safe operation of the equipment.

Table 4.2. Weekly PMCS.

Check:	Unserviceable If:
Power Cable: Inspect for frayed or damaged insulation over visible length of cord and at entry point to unit.	Power cable is frayed or damaged.
Interconnecting Wiring: Inspect for frayed or damaged insulation over visible portion of wires.	Any wire is frayed or damaged.

Table 4.3. Monthly PMCS.

Check:	Unserviceable If:
Cover, Screens, and Panels: Check for dirt or obstruction of screens. (Remove obstruction or clean as necessary.) Check for loose or missing attaching hardware.	Cover or screen is missing, loose, or damaged to the point of interfering with safe operation.
Air Filter: Remove air filter and check for cleanliness and damage. (Replace as necessary.)	Return air filter is dirty enough to cause obstruction to airflow.
Outside Surface of Unit: Inspect for cracks, dents in the frame, or panels. Check for chipped or missing paint and any evidence of corrosion.	Cracks or dents in the frame interfere with safe operation.
Identification Plates: Check that identification plates are securely attached to unit and can be easily read.	

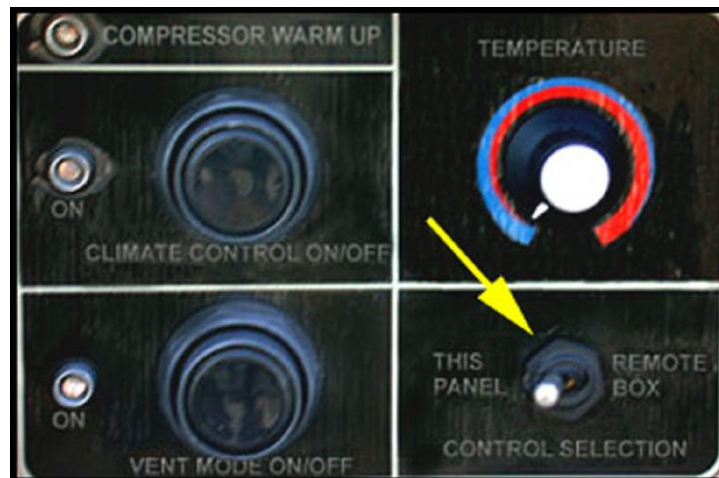
4.4.2. **Start and Operate the FDECU.** After connecting the power supply and performing PMCS, make a final check to confirm the drain hose will drain away from the unit and that the FDECU cover is down and secured by the latch pins. Also, verify the fan cover door is open and secured with the quick release pin. Start the unit according to procedures in the following paragraphs. **Note.** Before starting FDECU-2 models, refer to T.O. 35E9-314-1 for operating limits due to compressor warm-up delays.

WARNING

Dangerous and lethal voltage is used in the operation of the FDECU. Personal injury or death can result if power is not isolated from the unit during maintenance when panels and doors are open.

4.4.2.1. Choose which control panel will be used (unit or remote), then position the Control Selection toggle switch to either “THIS PANEL” or “REMOTE BOX” as highlighted in **Figure 4.18**.

Figure 4.18. Control Selection Toggle Switch (FDECU-2 Panel).



WARNING

Rotating parts are used in operating the FDECU. Do not install or adjust return air duct when inside blower is operating. The flange assembly can disengage and come off, resulting in personal injury.

4.4.2.2. To operate in the vent mode, push the vent mode button (**Figure 4.18**) to activate the inside blower. The ON indicator light will illuminate and the shelter air will begin to circulate. This will not control the temperature.

4.4.2.3. To operate in the climate control mode (heating and air conditioning); set the temperature knob (**Figure 4.18**) to about the one o'clock position or to "normal operation" on some models. This position is approximately 75° F. Then push the climate control button (**Figure 4.18**) to activate the automatic temperature control system. The ON indicator light will illuminate. In some instances, immediate operation may be prevented by the control logic time-out circuit. If this occurs, do not turn the unit off; it should start automatically within 5 minutes. **Note.** For FDECU-2 models, if the compressor warm up indicator light (**Figure 4.18**) is illuminated, the compressor is still warming and will not operate. However, the unit will operate in vent or resistance heat mode.

4.4.2.4. When the system is fully operating in the climate control mode, use the temperature knob to increase or decrease the shelter air temperature within a range of 60° F to 100° F. The unit will maintain the temperature to within 5° F of the setting. If the unit is operating in the cooling mode after start up, do not adjust the temperature knob for several hours until the shelter air temperature stabilizes.

4.4.2.5. If the inside coil ices over, operate the unit in the vent mode until the coil de-ices. For severe coil ice over, operate the unit in the heat mode (approximately 10-15 minutes) to de-ice the coil.

4.4.3. **Perform "During Operation" Checks.** Once the FDECU is operating, make periodic checks according to **Table 4.4**.

Table 4.4. FDECU “During Operation” PMCS.

Check:	Unserviceable If:
Liquid Refrigerant Indicator (Sight Glass): Inspect the liquid refrigerant indicator port for constant bubbles, foam, or to see if the center indicator color is red or yellow, depending on type of indicator being used.	The liquid refrigerant indicator port shows constant bubbles or foam or if the center indicator color is red or yellow, depending on the type of indicator being used.
Condensate Drain Hose: When in cooling mode, check that water is dripping from the hose end. If water is dripping from other areas, notify unit maintenance.	

4.4.4. **Operation under Unusual Conditions.** Like many HVAC/R systems, environmental conditions may affect the operational efficiency of the FDECU. Conditions such as extreme heat or cold, snow, dust or sand storms, and CBRN agents or materials can present special challenges during FDECU operation.

4.4.4.1. **Extreme Heat.** In extreme hot weather conditions, the load or strain on the FDECU can be significant. The best way to reduce demand on the system is to open and close the shelter as little as possible. If fresh outside make-up air is not required, position the return air duct over the perforated holes on the unit’s return air flange. Do not maintain the shelter temperature any lower than necessary. If possible, provide shade over the unit and always ensure there are no obstructions to airflow through the FDECU.

4.4.4.2. **Extreme Cold and Snow.** Just as during extreme heat conditions, in extreme cold weather conditions, open and close the shelter as little as possible. Position the return air duct over the perforated holes on the return air flange if outside make-up air is not required. Make sure any openings in the shelter are sealed, and try not to maintain shelter temperature higher than necessary. In snowy conditions, the area around the unit should be kept clear to prevent obstructions caused by snow build-up. Additionally, when the unit

defrosts ice from the outside coil, water drains from the bottom of the unit and could cause ice to build up and collect in this area. If not previously accomplished, it may be necessary to raise the unit to prevent water collection.

CAUTION

Extreme cold can cause electrical wire leads and insulation to become brittle. Do not disturb electrical wiring that has been exposed to extremely low temperatures because damage to wire leads or insulation could occur.

4.4.4.3. Dust and Sand Storms. Although the FDECU does not require any special protection procedures against conditions such as dust and sand storms, the unit should be cleaned more frequently than under normal conditions. If fresh outside make-up air is not required, position the air duct over perforated holes on the return air flange. The return air filter will also require cleaning more frequently.

4.4.4.4. CBRN Agents or Materials. Operating the FDECU in a CBRN environment requires the attachment of special blowers, filters and adapters. The unit should be operated according to instructions supplied with the CBRN adapter kit. Refer to T.O. 35E9-314-1 for specific procedures when configuring and operating the FDECU with CBRN equipment.

4.5. Shutdown Procedures. FDECU shutdown procedures depend on which mode the unit is operating. If operating in the heating and air conditioning mode, push the climate control button to deactivate the automatic temperature control system. If operating in the ventilation mode, push the vent mode button to deactivate the inside blower. In both instances, the ON indicator light will go out after the button is pushed. Afterward, unclip the quick release pin on the fan cover door. Close and secure the door with the door fasteners.

4.6. Preparation for Storage or Shipment. When FDECU operations are completed, several actions need to be accomplished before storing or shipping the unit. First, operate the FDECU in the vent mode for approximately one hour to ensure that any condensate is drained from the unit and to dry out the inside coil and ducts. Then, complete the following steps:

WARNING

Rotating parts and lethal voltage levels are used in operating the FDECU. Be sure power source is disconnected after shutdown. Injury or death can occur if connected to power source.

4.6.1. Shutdown the FDECU and disconnect it from the power source.

4.6.2. If applicable, disconnect and secure CBRN adapter kit according to T.O. 35E9-314-1.

4.6.3. Loosen the clamps and remove both air ducts. Be sure the ducts are dry, and then set the ducts and clamps aside for storage inside the unit.

WARNING

The FDECU cover is heavy. Be sure the cover retaining rod is in place and properly secured with the hair cotter pin. Injury can occur if the cover drops.

4.6.4. Raise and secure the FDECU cover. Make sure the hair cotter pin securing the cover is installed into the rod from the top.

4.6.5. If used, remove the remote control panel from the shelter and secure it inside the FDECU. Remember, if the remote control storage bracket from the FDECU was used to mount the remote control panel inside the shelter, it must be installed back into the unit.

4.6.6. Install the supply and return air shipping covers in their reverse order of removal. Make sure the heater barrel is pushed inside the supply air volute and properly secured with the four quick-release pins. Position and secure both shipping covers with cover screws.

4.6.7. Store the condensate drain hose in the reverse order it was removed. Be sure there is no water inside the hose and that the hose is coiled around the heater barrel for storage.

4.6.8. Pack the air ducts down into the FDECU, and then carefully coil the input power cable assembly around the ducts. Drape the power cable connector down into the air ducts to hold them down.

4.6.9. Close the FDECU cover and secure with the cover latch pins.



Chapter 5

130K MULTI-FUELED PORTABLE HEATER

5.1. General Information. The 130K Portable Heater (**Figure 5.1**) is the main heater for BEAR sets. Its principle purpose is to provide heated air for shelters and working areas. As indicated by its name, the heater has a heated air output of 130,000 BTUH at 0° F and is capable of burning several types of fuel. The overall design concept of the heater is modular. All major components are easily accessible for maintenance and can be easily removed and installed. Because the heater uses a fuel-fired system, operators should exercise extreme care and observe all technical order warnings and cautions to ensure safe operation.

Figure 5.1. 130K Heater.



5.2. Characteristics and Features. The unit is a fully enclosed, skid-mounted heater with three temperature ranges: high, medium, and low. The basic design of the heater features a separate electric-motor-driven oil burner with separate blower for combustion air and an electric-motor-driven heater

blower. It uses 120 Volts, 50/60 Hz generator or commercial power to operate the oil burner and combustion air blower. The heater will deliver hot air at a minimum of 1000 cubic feet per minute (CFM) and at temperatures ranging from 80° F to 180° F. The heated air output performance of the 130K heater makes it ideal for use during extremely cold conditions. Other external and internal features include the following.

5.2.1. **External Features:** Listed below and illustrated in **Figure 5.2**.

5.2.1.1. **Covers.** The sheet metal covers protect internal components of the heater from open environments. Top covers for the combustion chamber/heat exchanger and blower are easily removed, allowing easy access to major components. The control panel/burner compartment has a hinged cover panel.

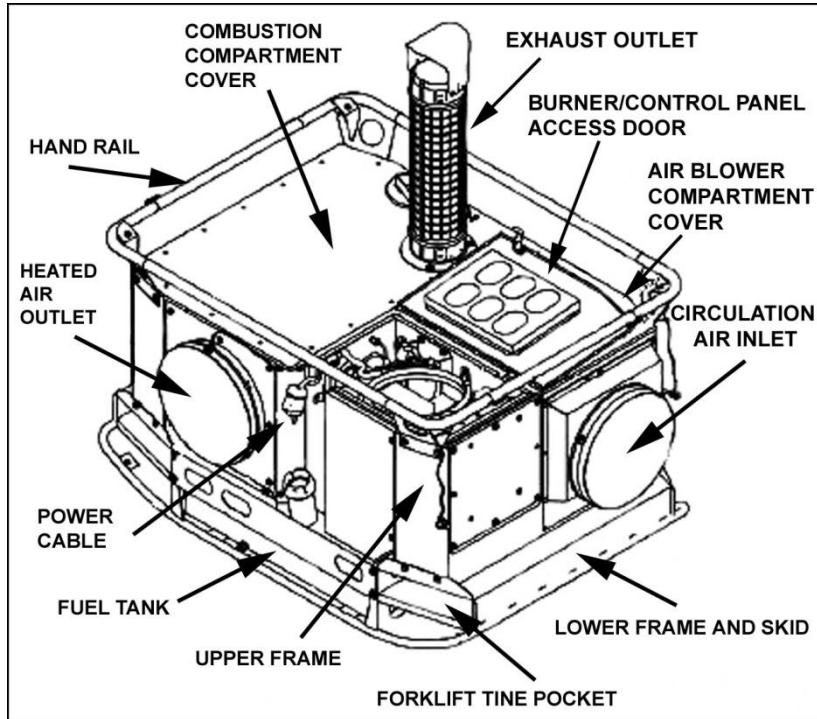
5.2.1.2. **Frame.** The heater is constructed with an upper and lower frame. The lower frame has an integrated skid for easy maneuverability, and fork-lift boxes that are accessible from the long sides of the heater.

5.2.1.3. **Fuel Tank and Fuel Gauge.** The all-metal, on-board fuel tank is located in the lower frame and has a storage capacity of 21 gallons. The fuel gauge is a mechanical, float-type gauge and is part of the fuel fill cap. The gauge is easily viewed without opening any heater covers.

5.2.1.4. **Air Inlet and Outlet.** Shelter or facility air returns to the heater through the circulation air inlet, and heated air is supplied to the shelter or facility via the heated air outlet.

5.2.1.5. **Power Cable.** The power cable extends from the burner compartment and plugs into a 120 Volt, 20 Amp maximum power source. The green indicator light on the control panel verifies the presence of voltage.

5.2.1.6. **Exhaust Outlet.** Combustion fumes, which are completely separated from heated air, exit through the exhaust outlet at the top of the heater.

Figure 5.2. External Features.

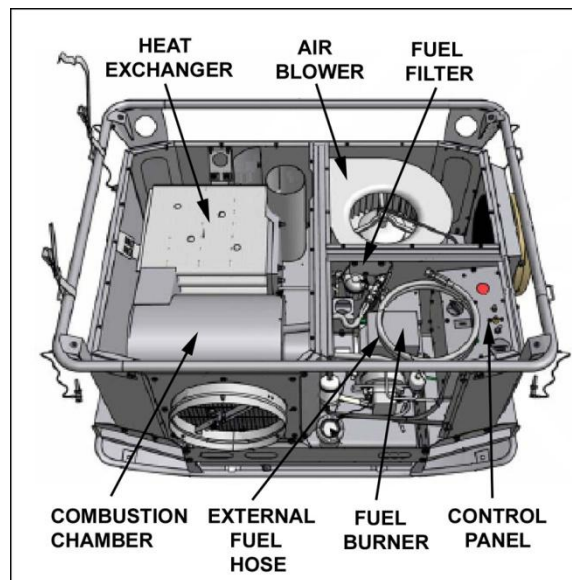
5.2.2. **Internal Features:** Listed below and illustrated in **Figure 5.3**.

5.2.2.1. **Fuel Feed Hose (External Tank).** The heater is equipped with an alternative fuel feed hose for attachment to an external fuel tank. The on-board or external fuel tank is selected using a 3-way valve attached to the fuel lines.

5.2.2.2. **Fuel Filter.** The fuel filter lies between the 3-way valve and the fuel injection pump. It filters fuel from both the external and on-board fuel tanks before the fuel is pumped into the burner nozzle.

5.2.2.3. Fuel Burner and Burner Control Unit. The fuel burner is a standard, commercial fuel burner. It consists of an electric motor to drive the combustion air blower and high-pressure fuel injection pump, and an ignition transformer, both of which are visible and accessible from outside of the burner frame. The burner control unit (BCU) is a microprocessor-equipped control unit located inside the heater control box. The BCU controls the function and safety of the fuel burner.

Figure 5.3. Internal Features.



5.2.2.4. Main Air Blower. The heater blower operates at a nominal 1000 CFM and forces heated air through the heater housing, around the burner chamber, and through the heat exchanger. Thermal energy is transferred from the hot surfaces of the combustion components into the circulating air. The heated air is supplied to the facility via the flexible ducts. The blower's electric motor is 120 Volt, 50/60 Hz, running at 1700 Revolutions per Minute (RPM).

5.2.2.5. **Combustion Chamber.** The heater combustion chamber houses the fuel burner tube and provides an exit route for exhaust gases. Flame is contained inside the burner chamber, thus only hot exhaust gases exit the chamber to the heat exchanger.

5.2.2.6. **Heat Exchanger.** Hot combustion exhaust gases from the combustion chamber pass through the heat exchanger during burner operation. Thermal energy is conducted and transferred into discharge air, which is blown past the heat exchanger channels by the main air blower. Exhaust gases remain completely separated from the heated air, and the gases exit through the exhaust outlet and into open air.

5.2.2.7. **External Thermostat and Carbon Monoxide (CO) Monitor.** The external thermostat and CO Monitor (**Figure 5.4**) are critical components of the heater unit. The external thermostat remotely controls heater operation when the mode switch on the control panel is set to "AUTO." The CO Monitor continuously checks the level of carbon monoxide within the shelter or facility and sounds an alarm if permitted levels are exceeded. The heater unit should never be used without a properly located and functioning CO Monitor. The thermostat/monitor should hang in a central position within the shelter or facility being heated.

Figure 5.4. External Thermostat and CO Monitor.



5.2.2.8. **Control Panel.** The heater control panel is the top portion of the heater control box, and it is located just underneath the burner/control panel access door. The control panel contains the heater control switch, heater mode switch, panel light and switch, heater hour meter, flame failure reset button, and digital display. **Figure 5.5** and **Table 5.1** highlight the component functions on the control panel. **Table 5.2** describes the meaning of digital display messages.

Figure 5.5. Heater Control Panel.

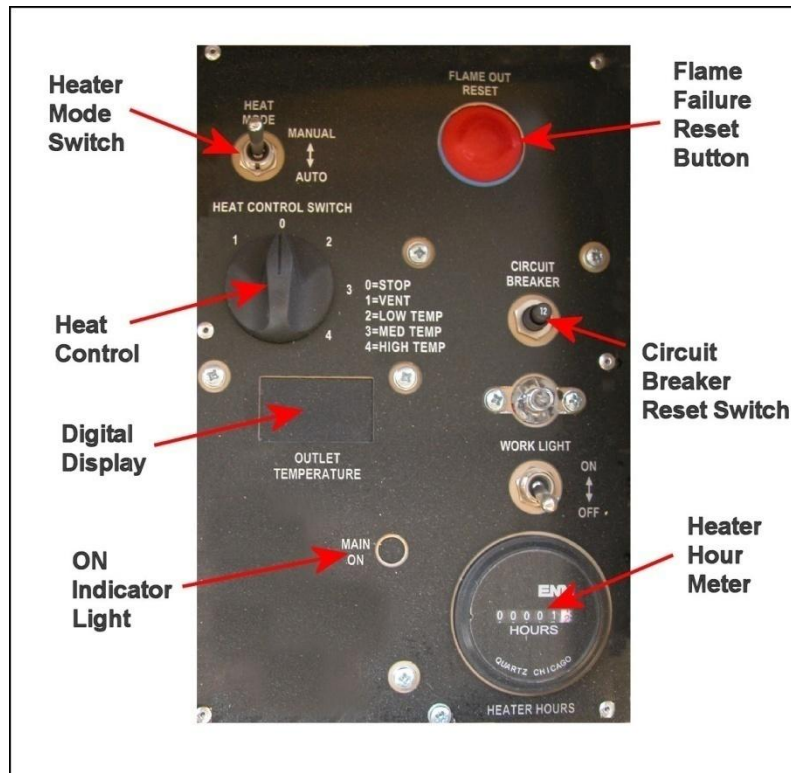


Table 5.1. 130K Heater Control Panel Components and Function.

Item	Function
Heater Control Switch	Used to select temperature settings (Low, Medium, or High) or "Vent" for unheated airflow only. Combustion begins once a temperature setting is selected.
Heater Mode Switch	Used to select the operating mode (Manual or Auto) for the heater unit. The "Auto" mode is for remote thermostat-controlled operation, and the "Manual" mode is for constant outlet temperature.
Function Digital Display	Displays the output air temperature (in 5° F increments), heater operation status, burner (failure and overheat) alarm, and problem diagnostic messages (see Table 5.2).
Flame Failure Reset Button	Reactivates the burner in case of a flame failure.
Circuit Breaker Reset Switch	Resets the heater's circuit breaker when the circuit breaker is tripped off.
Control Panel Light Switch	Activates the control panel light to illuminate the panel and operating instructions located on the panel door.
Heater Hour Meter	Displays the total number of hours of heater operation.
Main ON Indicator Light	Indicates that power is supplied to the heater unit.

Table 5.2. Heater Control Panel Display Messages.

Display	Meaning
OFF	The Heat Control Switch in –STOP” position and the power source is connected. The heater is cool/cold. The burner is off. The main air blower is off after cooling. The power cable can be disconnected.
AFC	The Heat Control Switch has been turned from HIGH, MED, or LOW output setting to the –STOP” position. After-cooling (AFC) is in process. The main air blower is still on. DO NOT disconnect power cable before display shows –OFF.”
FAN	The Heat Control Switch is in the –VENT” position. The main air blower is blowing. There is No heating--the burner is off.
LO	The Heat Control Switch is in –HIGH/MED/LOW.” Air outlet temperature is 39° F or less. The burner is ON but has not yet raised the outlet temperature above 39° F.
LO (Blinking)	The burner has been on for at least five minutes and the outlet air temperature is below 32° F. Probable cause of this condition is either sensor/sensor wiring problem or burner failure. Correct this error by turning the heat control switch briefly to –STOP,” then back to the heating position. Refer to Troubleshooting in T.O. 35E7-3-4-1, <i>Operation and Maintenance Instructions with Illustrated Parts Breakdown, Heater, 130K Multi-Fueled, Portable, Duct Type</i> , if this procedure does not solve the problem.
HI (Blinking)	Overheated outlet air (225° F or above) situation, sensor problem or sensor wiring problem. Forced main air blower cooling occurs. Correct this error by turning the heat control switch briefly to –STOP,” then back to the heating position. Refer to Troubleshooting in T.O. 35E7-3-4-1 if this procedure does not solve the problem.

5.3. Set-Up Procedures. Specific steps to set up the heater are as follows.

CAUTION

When using a forklift to move the heater, ensure the forklift tines are in the forklift pockets provided and extend completely under the heater unit. Failure to comply may result in serious equipment damage.

5.3.1. Siting the 130K Heater. Place the heater in an operating position near the shelter or desired structure (**Figure 5.6**). Select a location that is as level as possible not exceeding eight degrees in any direction. Attempt to avoid locating the heater in the path of normal shelter or facility pedestrian traffic, and leave adequate room for operation, maintenance, and refueling of the heater unit. When positioning the unit next to the desired facility, be sure to position air ducts in a manner that avoids sharp bends or kinks. Kinks in the air ducts impede airflow and decrease efficiency.

Figure 5.6. 130K Heater Sited Near Tent.



5.3.2. Preparation for Use and Preliminary Adjustments. When preparing the heater for use, complete the following checks and preliminary adjustments before operating the heater unit.

WARNING

Do not wear metal frame glasses, rings, watches, or other metal jewelry while working on electronic equipment.

5.3.2.1. Examine the equipment for damage and the presence of all required parts. Ensure the exhaust extension is positioned inside the exhaust ring on top of the heater (**Figure 5.7**). Inspect for damaged gauges and meters, loose connections or mountings, loose or missing hardware, and frayed insulation or wiring. Check all tubing and hoses for secure connections and for any evidence of damage.

Figure 5.7. Exhaust Extension (Stack) Installation.



WARNING

Do not add fuel until the heater has properly cooled according to instructions in heater shutdown procedures. Failure to comply may result in equipment damage, bodily injury, or death.

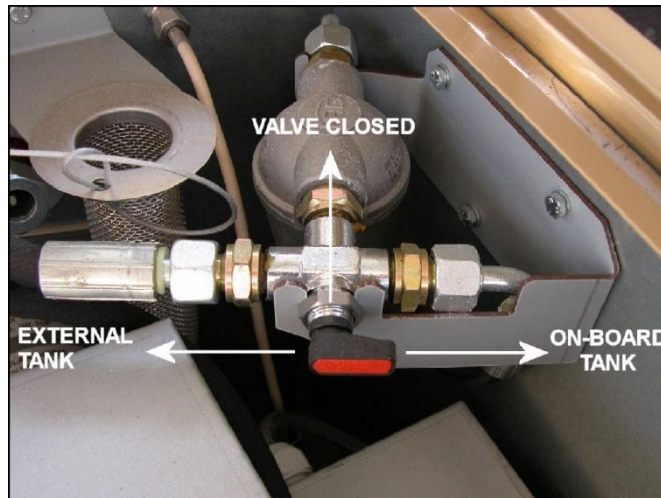
5.3.2.2. Check the fuel level to ensure the fuel supply is sufficient for the planned duration of operation. If not, fill the on-board fuel tank as follows. First, remove the fuel tank filler cap and install the fuel filler strainer inside the filler tube. Then fill the fuel tank with the appropriate fuel type (see **Table 5.3**). Do not fill the tank any higher than the lower end of the filler tube. Afterward, remove and store the fuel strainer in its holder inside the burner compartment. Reinstall the filler cap when completed.

Table 5.3. 130K Heater Operating Fuel Types.

Fuel Types	
Diesel	DF-1 and DF-2
Jet Fuel	Jet A and JetA1, JP-4, JP-5, and JP-8

5.3.2.3. If using an external fuel tank, uncoil the alternative fuel feed hose, and then connect it to the external fuel tank. Turn the three-way fuel valve (**Figure 5.8**) to select fuel from the external tank.

Figure 5.8. Fuel Three-Way Valve Positions.



5.3.2.4. Connect the air outlet and recirculation ducts (**Figure 5.9**) between the heater and shelter according to the shelter instructions. Secure the heater's duct end adapters in the frame by a slight clockwise rotation. If required, introduce fresh air into the circulation by opening the fresh air collar (**Figure 5.10**) as follows: Loosen the collar retainer bolt and turn the collar to the desired position (adjusting clockwise results in more fresh air).

Figure 5.9. Air Duct Connection.

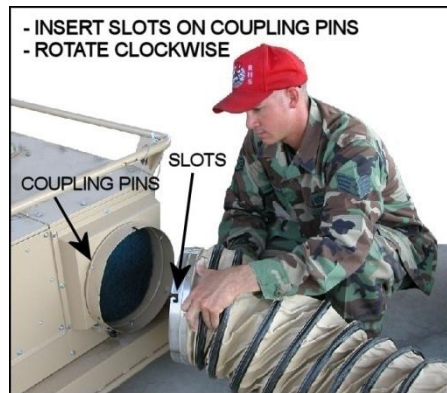
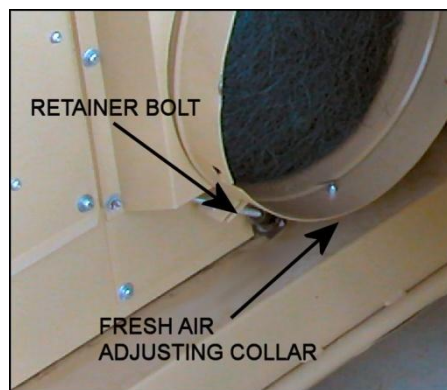


Figure 5.10. Fresh Air Adjustment.



WARNING

Dangerous voltages are present at electric system connectors. Ensure power is OFF (power cable disconnected) prior to connecting or disconnecting cables or wires.

WARNING

The CO monitor is a delicate, calibrated instrument, so do not attempt any repairs. Change the monitor if it is defective. Failure to comply may result in bodily injury or death.

5.3.2.5. Connect the external thermostat/CO monitor cable into the receptacle under the control box. Bring the thermostat/CO monitor combination into the space being heated. Do not place the external thermostat in the direct vicinity of the warm air discharge duct. Instead, hang the thermostat/CO monitor in a central position. When power is applied, make sure the green "POWER" light is ON in the CO monitor and the alarm sounds for a few seconds, indicating that the monitor is activated. If the green "POWER" light does not illuminate when power is applied to the CO monitor or the alarm fails to sound when the "TEST" button is pushed, change the monitor before using the heater. CO monitor function can also be tested by briefly pushing the "TEST" button. The alarm should sound when the button is pushed.

WARNING

Never operate the heater without a functional carbon monoxide (CO) monitor properly connected and located. Failure to comply may result in bodily injury or death.

WARNING

The heater is unsafe for operation in explosive atmospheres. Attempting to start the heater in an explosive atmosphere may result in bodily injury or death.

5.4. Operation. The heater operating controls and indicators are located on the control panel. Access the heater controls by opening the burner/control panel compartment cover on the top, right side of the heater. **Note.** Do not operate the heater without air ducts installed, except during maintenance.

WARNING

If the heater is operated for maintenance inside a building, exhaust gases must be vented to the outside by means of a suitable exhaust vent system. Do not apply a forced-draft (suction) type exhaust system directly to the heat exchanger exhaust. Utilize an exhaust hood or locally manufacture an exhaust vent adapter to mate with facilities exhaust venting system. The exhaust vent adapter must provide a minimum of 6 inches of free air space between the upper end of the exhaust stack and the hood. Failure to comply could result in bodily injury or death.

5.4.1. Connect the power cable plug into a 120 Volt, 60/50 Hz, 20 Amp (maximum) power source. Open the control panel cover and verify the green indicator light is illuminated.

5.4.2. Once power is supplied to the heater, set the mode switch on the control panel to either —**AUTO**” for remote thermostat-controlled operation or —**MANUAL**” for constant outlet temperature. If the —**MANUAL** mode is selected, turn the heat control switch to the desired outlet temperature (see **Table 5.4**). If in the —**AUTO**” mode, turn the heat control switch to —**HIGH**” and set the desired temperature on the remote thermostat.

5.4.3. Make sure the remote thermostat is located in a central place within the space to be heated. **Note.** Do not place the external thermostat in the direct vicinity of the warm air discharge duct.

Table 5.4. Heat Control Switch Settings.

Switch Position	Output Air
VENT	Unheated Ventilating Air
LOW TEMP	80° F – 140° F
MED TEMP	100° F – 160° F
HIGH TEMP	120° F – 180° F

CAUTION

When shutting down the heater, do not disconnect the power cable from the power source until the panel display message reads "OFF." Disconnecting the cable before the display reads "OFF" may damage combustion components.

WARNING

Heater can generate enough heat in certain locations to cause severe burns upon physical contact. Allow heater to cool before touching.

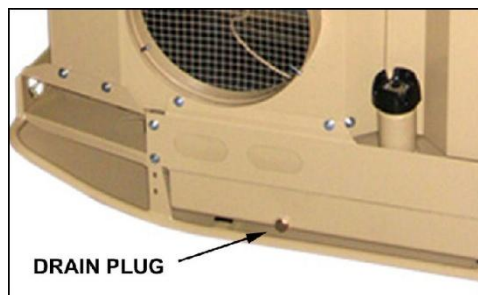
5.5. Shutdown Procedures. Always position the mode switch to "MANUAL" before shutting down the heater. Then turn the heat control switch to "STOP" and allow the heater to perform its after-cooling function (ACF). When the display message reads "OFF" and the blower has stopped, disconnect the heater power cable. After that, close and latch the control panel cover. In the event of an emergency or fire, disconnect the power cable to perform an emergency heater shutdown. Although this action may damage the heater's combustion components, it is the safest and quickest way to terminate heater operations in an emergency.

5.6. Preparation for Storage or Shipment. Perform the following procedures when preparing the heater for storage or shipment.

5.6.1. Disconnect the power cable from the power source. Coil the cable and stow it in the heater burner compartment.

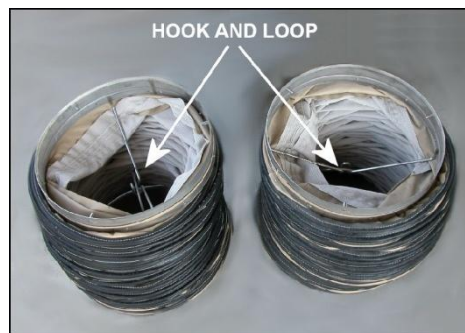
5.6.2. Drain the fuel from the fuel tank by opening the drain plug on the tank (**Figure 5.11**) and draining the fuel contents into a suitable container.

Figure 5.11. Fuel Tank Drain.



5.6.3. Remove the air ducts from the heater. Compress ducts and secure them with hook and loop provided inside ducts (**Figure 5.12**) to secure in transport configuration.

Figure 5.12. Ducts Secured with Hook and Loop.



5.6.4. Cover the heater air inlet and outlet adapters with the adapter covers (**Figure 5.13**).

Figure 5.13. Adapter Cover Installation.

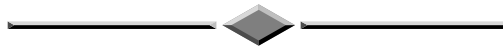


5.6.5. Remove the external thermostat from the shelter. Coil the cable and insert the cable and thermostat into heater burner compartment.

5.6.6. If the external fuel feed hose was used, remove the hose from the external fuel container, coil the hose, then stow the hose in the burner compartment.

5.6.7. Remove the flue gas exhaust extension, and cover the heater exhaust outlet with the steel cap provided.

5.6.8. The remaining packing procedures are dependent on the method of shipment. When preparing the heater unit for air shipment, make sure the fuel tank cap is installed and properly tightened and the air vent hole is open and unobstructed. This action will permit pressure equalization during altitude and temperature changes. Refer to T.O. 35E7-3-4-1 and T.O. 35-1-4, *Processing and Inspection of Aerospace Ground Equipment for Storage and Shipment*, for more information on preparing the heater unit for storage or shipment.



Chapter 6

INFORMATION COLLECTION, RECORDS, AND FORMS

6.1. Information Collections. No information collections are created by this publication.

6.2. Records. The program records created as a result of the processes prescribed in this publication are maintained in accordance with AFMAN 33-363 and disposed of in accordance with the AFRIMS RDS located at <https://www.my.af.mil/gcss-af61a/afirms/afirms/>.

6.3. Forms (Adopted and Prescribed).

6.3.1. **Adopted Forms.** AF IMT 847, *Recommendation for Change of Publication*.

6.3.2. **Prescribed Forms.** No prescribed forms are implemented in this publication.

MICHAEL A. AIMONE, SES
Assistant DCS/Logistics, Installations, & Mission
Support



Attachment 1

GLOSSARY OF REFERENCES AND SUPPORTING INFORMATION

References

AFI 10-209, *RED HORSE Program*, 13 May 2008

AFI 10-210, *Prime Base Engineer Emergency Force (BEEF) Program*, 21 March 2008

AFI 32-1064, *Electrical Safe Practices*, 25 May 2006

AFMAN 33-363, *Management of Records*, 1 March 2008

AFPAM 10-219, Volume 5, *Bare Base Conceptual Planning Guide*, 1 June 1996

AFPAM 10-219, Volume 7, *Expedient Methods*, 9 June 2008

T.O. 35-1-4, *Processing and Inspection of Aerospace Ground Equipment for Storage and Shipment*, 30 September 1995

T.O. 35E7-3-4-1, *Operation and Maintenance Instructions with Illustrated Parts Breakdown, Heater, 130K Multi-Fueled, Portable, Duct Type*, 1 July 2007

T.O. 35E7-4-27-1, *Operator's, Unit and Direct Support Maintenance Manual, Heater, Water, Liquid Fuel, M-80 and M-8*, 30 June 2005

T.O. 35E9-314-1, *Operator, Unit, Direct Support and General Support Maintenance Manual, Field Deployable Environmental Control Unit (FDECU)*, 1 February 2006

T.O. 35E35-3-1, *Operation, Storage, Inspection and Maintenance Instructions with Illustrated Parts Breakdown, Shave Stand Bare Base, Erection, Part No. 8611370*, 1 September 1987

T.O. 35E35-4-1, *Operation, Storage, Inspection and Maintenance Instructions with Illustrated Parts Breakdown, Shower Facility Bare Base, Erection*, 1 September 1987

T.O. 35E4-169-1, *Operation, Storage, Inspection and Maintenance Instructions with Illustrated Parts Breakdown, Harvest Falcon/Eagle Kitchen Facility, Erection*, 30 May 2003

T.O. 35E4-169-21, *Operation and Maintenance Instructions with Illustrated Parts Breakdown, Initial Deployment Kitchen*, 2 November 1999

T.O. 35E4-169-31, *Erection, Operation, Storage, Inspection and Maintenance Instructions with Illustrated Parts Breakdown, Bare Base Harvest Falcon/Eagle Electric Kitchen with Mess Kit Laundry*, 1 May 2006

T.O. 40R7-6-1, *Operator's, Unit, and Direct Support Maintenance Manual, Advanced Design Refrigerator, 300 Cubic Foot, (ADR-300)*, 7 February 2007

Abbreviations and Acronyms

AC—Alternating Current

ACF—After-Cooling Function

ADR—Advanced Design Refrigerator

AF—Air Force

AFCESA—Air Force Civil Engineer Support Agency

AFH—Air Force Handbook

AFI—Air Force Instruction

AFIMS—Air Force Incident Management System

AFMAN—Air Force Manual

AFPAM—Air Force Pamphlet

AFRIMS—Air Force Records Information Management System

AFS—Air Force Specialty

AFSC—Air Force Specialty Code

BCU—Burner Control Unit

BEAR—Basic Expeditionary Airfield Resources
BTU—British Thermal Units
BTUH—British Thermal Units per Hour
CBRN—Chemical, Biological, Radiological, and Nuclear
CO—Carbon Monoxide
FDECU— Field Deployable Environmental Control Unit
GPM—Gallons per Minute
HPCO—High-Pressure Cut-Out
HQ—Headquarters
HVAC/R—Heating, Ventilation, Air Conditioning, and Refrigeration
Hz—Hertz
IMT—Information Management Tool
IR—Infrared
LBS—Pounds
LPCO—Low-Pressure Cut-Out
MAJCOM—Major Command
OPR—Office of Primary Responsibility
PMCS—Preventive Maintenance Checks and Services
PRIME BEEF—Prime Base Engineer Emergency Force
PSI—Pounds per Square Inch
QD—Quick Disconnect
RDS—Records Disposition Schedule
RED HORSE—Rapid Engineer Deployable Heavy Operational Repair Squadron Engineer

RPM—Revolutions per Minute

SCFM—Standard Cubic Feet per Minute

TO—Technical Order

UV—Ultraviolet

VAC—Volt Alternating Current

Terms

Air Force Civil Engineer Support Agency (AFCESA)—A field operating agency (FOA) located at Tyndall Air Force Base, Florida. The Directorate of Contingency Support (HQ AFCESA/CEX) acts as the Air Force program manager for Base Civil Engineer (BCE) Contingency Response Planning.

Bare Base—An installation having minimum essential facilities to house, sustain, and support operations to include, if required, a stabilized runway, taxiways, and aircraft parking areas. A bare base must have a source of water that can be made potable. Other requirements to operate under bare base conditions form a necessary part of the force package deployed to the bare base.

Basic Expeditionary Airfield Resources (BEAR)—Facilities, equipment, and basic infrastructure to support the beddown of deployed forces and aircraft at austere locations; a critical capability to fielding expeditionary aerospace forces. Also known as BEAR, the resources include tents, field kitchens, latrine systems, shop equipment, electrical and power systems, runway systems, aircraft shelters, and water distribution systems needed to sustain operations.

Chemical, Biological, Radiological and Nuclear (CBRN) Defense—The methods, plans, procedures, and training required to establish defense measures against the effects of attack by nuclear weapons or chemical and biological agents.